



Electrification Products Division for Low Voltage Products Price List 2017/2018

About ABB

ABB is a leader in power and automation technologies that enable utility and industry customers to improve their performance while lowering environmental impact. The ABB Group of companies operates in around 100 countries and employs about 135,000 people.

ABB, the leading power and automation technology group, provides solutions for secure, energy-efficient generation, transmission and distribution of electricity and for increasing productivity in industrial, commercial and utility operations.

In Malaysia, we draw on the global R&D, knowledge, quality products and experience of the ABB Group and combine them with local customer interface, production and engineering capabilities.

List of contents

System pro M compact® Modular DIN Rail Component Products	3	1
Moulded Case Circuit Breakers (MCCB)	31	2
Air Circuit Breakers (ACB)	50	3
Switches	59	4
Capacitor Banks and Controllers	77	5
Contactors	83	6
Mini Contactors	103	7
Installation Contactors (ESB)	111	8
Thermal Overload Relays (TOR) & Electronic Overload Relays (EOLR)	115	9
Manual Motor Starters	125	10
Pilot Devices	131	11
Electronic Products & Relays	143	12
Wire Management & Connectivity (WMC)	153	13
Cable Protection, Explosion Proof and Lighting (CEL)	163	14
Low Voltage Products Solutions for Solar Energy	175	15
Low Voltage Products Solutions for Marine	181	16
Index by order code	185	

List of Products Sub-Contents

1. Modular DIN Rail Component Products

Miniature Circuit-Breakers

SH 200 L MCB	1/4
SH 200 MCB	1/5
S 200 MCB	1/6-7
S 200 M MCB	1/8-9
S 200 P MCB	1/10-11

Residual Current Device

FH 200 AC <input type="checkbox"/> Type RCCB	1/12
Auto Recloser	1/12
F 200 AC <input type="checkbox"/> Type RCCB	1/13-14
F 200 AP-R (high immunity), A <input type="checkbox"/> Type RCCB	1/15
DS 201 AC <input type="checkbox"/> Type, C characteristic RCBO	1/16

Accessories

For S 200 MCB, F 200 RCCB & Others	1/17-20
------------------------------------	---------

Surge Protective Devices

OVR Range : Type 1, Type 1 + 2	1/21
OVR Range : Type 2, Type 2 + 3	1/22

Command Devices

SHD200 Switch Disconnecter	1/23
SD200 Switch Disconnecter	1/24
Fuse Disconnectors	1/25
Electro-mechanical Time Switches	1/26

Front Panel Residual Current Relays

ELR: Earth Leakage Relay	1/26
Toroidal Transformer	1/26
Digital Power Meter	1/27
Electricity Meter	1/27

Distribution Boards (DB) / Consumer Units

MISTRAL Series	1/28
MICAL Series	1/29

2. Moulded Case Circuit Breakers (MCCB)

Formula MCCB Selection Table	2/32
------------------------------	------

Tmax MCCB Selection Table	2/33
---------------------------	------

Formula MCCB Series

A1N, A2N – 1 pole 25kA	2/34
A1N, A2N – 2 poles 50kA	2/34
A1A – 10kA	2/35
A1B, A2B – 18kA	2/35
A1C, A2C – 25kA	2/36
A1N, A2N, A3N – 36kA	2/37
A3S – 50kA	2/37
Formula MCCB A1 – A2 – A3 Accessories	2/38

Tmax MCCB Series

XT1B – 18kA	2/39
XT1C – 25kA	2/39
XT2N, XT4N, T4N, T5N, T6N – 36kA	2/40
XT2S, XT4S, T4S, T5S, T6S, T7S – 50kA	2/41
XT2H, XT4H, T4H, T5H, T6H, T7H – 70kA	2/42
Tmax XT1 – XT4 Accessories	2/43-45
Tmax T4 – T5 – T6 Accessories	2/46-47
Tmax T7 – T7M Accessories	2/48-49
Motorizable T7M	2/49

3. Air Circuit Breakers (ACB)

Emax 2 Series

ACB with Electronic Protection Unit	3/53
Switch Disconnectors	3/54
Emax 2 Accessories	3/55-57

List of Products Sub-Contents

4. Switches

Switch Disconnectors / Isolators / Load Break Switches

Product Overview	4/60-61
OT Series – 3 Poles	4/62
OT Series – 4 Poles	4/63

Manual Change-over Switches

Product Overview	4/64-65
OT_c Series, 4 Poles	4/66

Motorized Change-over Switches

Product Overview	4/67
OTM_c Series	4/68-69

Switch Fuses

Product Overview	4/70
OS – 3 Poles & 4 Poles	4/71

Accessories for Switches

4/72

Fuse Switches

XLP Series	4/73
------------	------

Fuselinks

500V, gG fuse, DIN	4/74
--------------------	------

Enclosed Switch-Disconnectors

Side Operated Fireman's Switches	4/75
Side Operated Switches-disconnectors	4/75
Accessories for Enclosed Switches	4/75

5. Capacitor Banks and Controllers

Low Voltage Power Capacitors

CLMD Series	5/78-79
RVC	5/80
RVT & RVT Accessories	5/81
QCap Series	5/82

6. Contactors

AX Range 3-Pole Contactor (AC Operating Voltage)	6/84
AF Range 3-Pole Contactor (AC/DC Operating Voltage)	6/85-88
AF Range 4-Pole Contactor (AC/DC Operating Voltage)	6/89-91
EK Range 4-Pole Contactors (AC Operating Voltage)	6/92
UA...RA Capacitor Switching Contactors	6/93-94
N/NX...Range Contactor Relays (AC Operating Voltage)	6/95
NF...Range Contactor Relays (DC Operating Voltage)	6/96

Contactor Accessories

Auxillary Contact	6/97-98
ABB Timer	6/99
Mechanical Interlock Units / Mechanical & Electrical Interlock Units	6/100
Connecting Links for Contactor & Manual Motor Starter	6/101
Contactor Coils	6/102

7. Mini Contactors

B 6/BC 6 Range	7/104
B 7/BC 7 Range	7/104
VB 6/VBC 6 Range	7/105
VB 7/VBC 7 Range	7/105
Interface Motor Contactors BC 6/BC 7 Range	7/106
K 6/KC 6 Range	7/107
TBC 7 Range	7/108
TKC 6 Range	7/108
Mini Contactor Accessories	7/109

8. Installation Contactors (ESB)

ESB 20	8/113
ESB 24	8/113
ESB 40	8/113
ESB 63	8/113

List of Products Sub-Contents

9. Thermal Overload Relays (TOR) & Electronic Overload Relays (EOLR)

T 16DU Range	9/116
TA25 DU...M Range	9/117
TA42 DU...M Range	9/118
TA75 DU...M Range	9/118
TA80 DU Range	9/118
TA110 DU Range	9/119
TA200 DU Range	9/119
TF42 Range	9/120
Thermal Overload Relays Accessories	9/121

Electronic Overload Relays

E16 DU – E1250 DU Range	9/122
Electronic Overload Relays Accessories	9/123

10. Manual Motor Starter

MS116 Range	10/126
MS132 Range	10/126
MS165 Range	10/127
MS495 Range	10/127
Manual Motor Starter Accessories	10/128-130

11. Pilot Devices

Modular Type:

Push Button (Non-illuminated)	11/134
Mushroom Pushbuttons	11/134
Emergency Stop Pushbuttons	11/135
Two-Position Selector Switches	11/136
Three-Position Selector Switches	11/136
Key-Operated Selector Switches	11/137
Toggle Switches	11/138
Push Button (Illuminated)	11/139
Pilot Light	11/140

Compact Type:

Push Button	11/141
Pilot Light with Integrated LED	11/142
Emergency Stop Push Button (Red)	11/142

12. Electronic Products & Relays

Single Phase Monitoring Relays	12/144
Voltage Monitoring Relays	12/144
Three-Phase Monitoring Relays	12/145
Thermistor Motor Protection Relays	12/146
Pluggable Interface Relays	12/147-150
Primary Switch Mode Power Supplies	12/151

13. Wire Management & Connectivity (WMC)

Ty-Rap® High Performance Cable Ties	13/154-155
Wiring Ducts	13/156-157
Spec-Kon® Cable Lugs	13/158-159
Spec-Kon® Cable Ties	13/160-161

14. Cable Protection, Explosion Proof and Lighting (CEL)

Adaptaflex	13/164-165
ABB Kopex-EX Cable Gland	14/166-169
ABB DTS Light Fittings	14/170-173

15. Low Voltage Products Solutions for Solar Energy

Miniature Circuit-Breakers

S 800 PV-S MCB	15/176-177
S 800 PV-M MCB	15/177

Fuse Disconnectors

E 90 PV	15/178
---------	--------

Cylindrical Fuses

E 9F PV	15/178
---------	--------

Surge Protective Devices

OVR range : PV	15/179
OVR range : Type 2, Type 2+3	15/179

OTDC Switch-disconnectors

15/180

16. Low Voltage Products Solutions for Marine

Low Voltage Products Solutions for Marine	15/183
---	--------

System pro M compact[®] Modular DIN Rail Component Products



Power and productivity
for a better world™



System pro M compact®

Modular DIN Rail Component Products

SH 200 L MCB

Standard: IEC/EN 60898

Icn = 4.5kA

Voltage range:

1P : 230V ~ 240VAC – 50/60Hz

2P, 3P & 4P : 230V ~ 415VAC – 50/60Hz

1 Pole



Rating (A)	Model	B curve (3 ~ 5 In)		Model	C curve (5 ~ 10 In)	
		Order Code	List Price (RM)		Order Code	List Price (RM)
6	SH201L-B6	2CDS241001R0065	30.70	SH201L-C6	2CDS241001R0064	22.20
10	SH201L-B10	2CDS241001R0105	30.70	SH201L-C10	2CDS241001R0104	22.20
16	SH201L-B16	2CDS241001R0165	30.70	SH201L-C16	2CDS241001R0164	22.20
20	SH201L-B20	2CDS241001R0205	30.70	SH201L-C20	2CDS241001R0204	22.20
25	SH201L-B25	2CDS241001R0255	30.70	SH201L-C25	2CDS241001R0254	22.20
32	SH201L-B32	2CDS241001R0325	30.70	SH201L-C32	2CDS241001R0324	22.20
40	SH201L-B40	2CDS241001R0405	30.70	SH201L-C40	2CDS241001R0404	22.20

2 Poles

Rating (A)	Model	B curve (3 ~ 5 In)		Model	C curve (5 ~ 10 In)	
		Order Code	List Price (RM)		Order Code	List Price (RM)
6	SH202L-B6	2CDS242001R0065	83.70	SH202L-C6	2CDS242001R0064	66.30
10	SH202L-B10	2CDS242001R0105	83.70	SH202L-C10	2CDS242001R0104	66.30
16	SH202L-B16	2CDS242001R0165	83.70	SH202L-C16	2CDS242001R0164	66.30
20	SH202L-B20	2CDS242001R0205	83.70	SH202L-C20	2CDS242001R0204	66.30
25	SH202L-B25	2CDS242001R0255	83.70	SH202L-C25	2CDS242001R0254	66.30
32	SH202L-B32	2CDS242001R0325	83.70	SH202L-C32	2CDS242001R0324	66.30
40	SH202L-B40	2CDS242001R0405	83.70	SH202L-C40	2CDS242001R0404	66.30

3 Poles

Rating (A)	Model	B curve (3 ~ 5 In)		Model	C curve (5 ~ 10 In)	
		Order Code	List Price (RM)		Order Code	List Price (RM)
6	SH203L-B6	2CDS243001R0065	122.50	SH203L-C6	2CDS243001R0064	100.40
10	SH203L-B10	2CDS243001R0105	122.50	SH203L-C10	2CDS243001R0104	100.40
16	SH203L-B16	2CDS243001R0165	122.50	SH203L-C16	2CDS243001R0164	100.40
20	SH203L-B20	2CDS243001R0205	122.50	SH203L-C20	2CDS243001R0204	100.40
25	SH203L-B25	2CDS243001R0255	122.50	SH203L-C25	2CDS243001R0254	100.40
32	SH203L-B32	2CDS243001R0325	122.50	SH203L-C32	2CDS243001R0324	100.40
40	SH203L-B40	2CDS243001R0405	122.50	SH203L-C40	2CDS243001R0404	100.40

System pro M compact®

Modular DIN Rail Component Products

1

SH 200 MCB

Standard: IEC/EN 60898

Icn = 6kA

Voltage range:

1P : 230V ~ 240VAC – 50/60Hz

2P, 3P & 4P : 230V ~ 415VAC – 50/60Hz

1 Pole



Rating (A)	Model	B curve (3 ~ 5 In)		Model	C curve (5 ~ 10 In)	
		Order Code	List Price (RM)		Order Code	List Price (RM)
6	SH201-B6	2CDS211001R0065	36.50	SH201-C6	2CDS211001R0064	24.10
10	SH201-B10	2CDS211001R0105	36.50	SH201-C10	2CDS211001R0104	24.10
16	SH201-B16	2CDS211001R0165	36.50	SH201-C16	2CDS211001R0164	24.10
20	SH201-B20	2CDS211001R0205	36.50	SH201-C20	2CDS211001R0204	24.10
25	SH201-B25	2CDS211001R0255	36.50	SH201-C25	2CDS211001R0254	24.10
32	SH201-B32	2CDS211001R0325	36.50	SH201-C32	2CDS211001R0324	24.10
40	SH201-B40	2CDS211001R0405	36.50	SH201-C40	2CDS211001R0404	24.10
50	SH201-B50	2CDS211001R0505	51.70	SH201-C50	2CDS211001R0504	34.40
63	SH201-B63	2CDS211001R0635	51.70	SH201-C63	2CDS211001R0634	34.40

2 Poles

Rating (A)	Model	B curve (3 ~ 5 In)		Model	C curve (5 ~ 10 In)	
		Order Code	List Price (RM)		Order Code	List Price (RM)
6	SH202-B6	2CDS212001R0065	95.80	SH202-C6	2CDS212001R0064	76.60
10	SH202-B10	2CDS212001R0105	95.80	SH202-C10	2CDS212001R0104	76.60
16	SH202-B16	2CDS212001R0165	95.80	SH202-C16	2CDS212001R0164	76.60
20	SH202-B20	2CDS212001R0205	95.80	SH202-C20	2CDS212001R0204	76.60
25	SH202-B25	2CDS212001R0255	95.80	SH202-C25	2CDS212001R0254	76.60
32	SH202-B32	2CDS212001R0325	95.80	SH202-C32	2CDS212001R0324	76.60
40	SH202-B40	2CDS212001R0405	95.80	SH202-C40	2CDS212001R0404	76.60
50	SH202-B50	2CDS212001R0505	135.30	SH202-C50	2CDS212001R0504	107.20
63	SH202-B63	2CDS212001R0635	135.30	SH202-C63	2CDS212001R0634	107.20

3 Poles

Rating (A)	Model	B curve (3 ~ 5 In)		Model	C curve (5 ~ 10 In)	
		Order Code	List Price (RM)		Order Code	List Price (RM)
6	SH203-B6	2CDS213001R0065	156.20	SH203-C6	2CDS213001R0064	118.40
10	SH203-B10	2CDS213001R0105	156.20	SH203-C10	2CDS213001R0104	118.40
16	SH203-B16	2CDS213001R0165	156.20	SH203-C16	2CDS213001R0164	118.40
20	SH203-B20	2CDS213001R0205	156.20	SH203-C20	2CDS213001R0204	118.40
25	SH203-B25	2CDS213001R0255	156.20	SH203-C25	2CDS213001R0254	118.40
32	SH203-B32	2CDS213001R0325	156.20	SH203-C32	2CDS213001R0324	118.40
40	SH203-B40	2CDS213001R0405	156.20	SH203-C40	2CDS213001R0404	118.40
50	SH203-B50	2CDS213001R0505	218.40	SH203-C50	2CDS213001R0504	166.00
63	SH203-B63	2CDS213001R0635	218.40	SH203-C63	2CDS213001R0634	166.00

*NOTE: All List Prices Excluding 6% GST

System pro M compact®

Modular DIN Rail Component Products

S 200 MCB

Standard : IEC/EN 60898, IEC/EN 60947-2
: UL1077

Icn = 6kA

Voltage range:

1P : 230V ~ 240VAC – 50/60Hz

2P, 3P & 4P : 230V ~ 415VAC – 50/60Hz



1 Pole

Rating (A)	Model	B curve (3 ~ 5 In)		Model	C curve (5 ~ 10 In)	
		Order Code	List Price (RM)		Order Code	List Price (RM)
6	S201-B6	2CDS251001R0065	40.90	S201-C6	2CDS251001R0064	28.60
10	S201-B10	2CDS251001R0105	40.90	S201-C10	2CDS251001R0104	28.60
16	S201-B16	2CDS251001R1165	40.90	S201-C16	2CDS251001R0164	28.60
20	S201-B20	2CDS251001R0205	40.90	S201-C20	2CDS251001R0204	28.60
25	S201-B25	2CDS251001R0255	40.90	S201-C25	2CDS251001R0254	28.60
32	S201-B32	2CDS251001R0325	40.90	S201-C32	2CDS251001R0324	28.60
40	S201-B40	2CDS251001R0405	40.90	S201-C40	2CDS251001R0404	28.60
50	S201-B50	2CDS251001R0505	66.40	S201-C50	2CDS251001R0504	40.90
63	S201-B63	2CDS251001R0635	66.40	S201-C63	2CDS251001R0634	40.90

2 Poles

Rating (A)	Model	B curve (3 ~ 5 In)		Model	C curve (5 ~ 10 In)	
		Order Code	List Price (RM)		Order Code	List Price (RM)
6	S202-B6	2CDS252001R0065	104.10	S202-C6	2CDS252001R0064	90.00
10	S202-B10	2CDS252001R0105	104.10	S202-C10	2CDS252001R0104	90.00
16	S202-B16	2CDS252001R0165	104.10	S202-C16	2CDS252001R0164	90.00
20	S202-B20	2CDS252001R0205	104.10	S202-C20	2CDS252001R0204	90.00
25	S202-B25	2CDS252001R0255	104.10	S202-C25	2CDS252001R0254	90.00
32	S202-B32	2CDS252001R0325	104.10	S202-C32	2CDS252001R0324	90.00
40	S202-B40	2CDS252001R0405	104.10	S202-C40	2CDS252001R0404	90.00
50	S202-B50	2CDS252001R0505	148.00	S202-C50	2CDS252001R0504	115.40
63	S202-B63	2CDS252001R0635	148.00	S202-C63	2CDS252001R0634	115.40

System pro M compact®

Modular DIN Rail Component Products

S 200 MCB

Standard : IEC/EN 60898, IEC/EN 60947-2
: UL1077

Icn = 6kA

Voltage range:

1P : 230V ~ 240VAC – 50/60Hz

2P, 3P & 4P : 230V ~ 415VAC – 50/60Hz

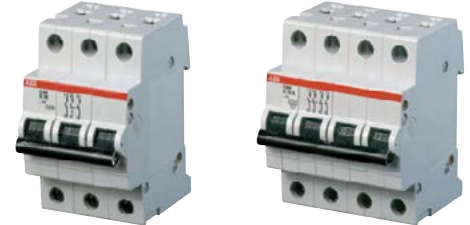

3 Poles

Rating (A)	Model	B curve (3 ~ 5 In)		C curve (5 ~ 10 In)		
		Order Code	List Price (RM)	Model	Order Code	List Price (RM)
6	S203-B6	2CDS253001R0065	173.50	S203-C6	2CDS253001R0064	141.50
10	S203-B10	2CDS253001R0105	173.50	S203-C10	2CDS253001R0104	141.50
16	S203-B16	2CDS253001R0165	173.50	S203-C16	2CDS253001R0164	141.50
20	S203-B20	2CDS253001R0205	173.50	S203-C20	2CDS253001R0204	141.50
25	S203-B25	2CDS253001R0255	173.50	S203-C25	2CDS253001R0254	141.50
32	S203-B32	2CDS253001R0325	173.50	S203-C32	2CDS253001R0324	141.50
40	S203-B40	2CDS253001R0405	173.50	S203-C40	2CDS253001R0404	141.50
50	S203-B50	2CDS253001R0505	234.70	S203-C50	2CDS253001R0504	219.10
63	S203-B63	2CDS253001R0635	234.70	S203-C63	2CDS253001R0634	219.10

4 Poles

Rating (A)	Model	B curve (3 ~ 5 In)		C curve (5 ~ 10 In)		
		Order Code	List Price (RM)	Model	Order Code	List Price (RM)
6	S204-B6	2CDS254001R0065	234.70	S204-C6	2CDS254001R0064	200.00
10	S204-B10	2CDS254001R0105	234.70	S204-C10	2CDS254001R0104	200.00
16	S204-B16	2CDS254001R0165	234.70	S204-C16	2CDS254001R0164	200.00
20	S204-B20	2CDS254001R0205	234.70	S204-C20	2CDS254001R0204	200.00
25	S204-B25	2CDS254001R0255	234.70	S204-C25	2CDS254001R0254	200.00
32	S204-B32	2CDS254001R0325	234.70	S204-C32	2CDS254001R0324	200.00
40	S204-B40	2CDS254001R0405	234.70	S204-C40	2CDS254001R0404	200.00
50	S204-B50	2CDS254001R0505	285.70	S204-C50	2CDS254001R0504	244.90
63	S204-B63	2CDS254001R0635	285.70	S204-C63	2CDS254001R0634	244.90

*NOTE: All List Prices Excluding 6% GST

System pro M compact®

Modular DIN Rail Component Products

S 200 M MCB

Standard : IEC/EN 60898, IEC/EN 60947-2
 : UL1077, CSA 22.2 No.235

Icn = 10kA

Voltage range:

1P : 230V ~ 240VAC – 50/60Hz

2P, 3P & 4P : 230V ~ 415VAC – 50/60Hz



1 Pole

Rating (A)	Model	B curve (3 ~ 5 In)		Model	C curve (5 ~ 10 In)	
		Order Code	List Price (RM)		Order Code	List Price (RM)
6	S201M-B6	2CDS271001R0065	76.00	S201M-C6	2CDS271001R0064	71.50
10	S201M-B10	2CDS271001R0105	76.00	S201M-C10	2CDS271001R0104	71.50
16	S201M-B16	2CDS271001R0165	76.00	S201M-C16	2CDS271001R0164	71.50
20	S201M-B20	2CDS271001R0205	76.00	S201M-C20	2CDS271001R0204	71.50
25	S201M-B25	2CDS271001R0255	76.00	S201M-C25	2CDS271001R0254	71.50
32	S201M-B32	2CDS271001R0325	76.00	S201M-C32	2CDS271001R0324	71.50
40	S201M-B40	2CDS271001R0405	76.00	S201M-C40	2CDS271001R0404	71.50
50	S201M-B50	2CDS271001R0505	130.20	S201M-C50	2CDS271001R0504	113.50
63	S201M-B63	2CDS271001R0635	130.20	S201M-C63	2CDS271001R0634	113.50

2 Poles

Rating (A)	Model	B curve (3 ~ 5 In)		Model	C curve (5 ~ 10 In)	
		Order Code	List Price (RM)		Order Code	List Price (RM)
6	S202M-B6	2CDS272001R0065	156.70	S202M-C6	2CDS272001R0064	144.70
10	S202M-B10	2CDS272001R0105	156.70	S202M-C10	2CDS272001R0104	144.70
16	S202M-B16	2CDS272001R0165	156.70	S202M-C16	2CDS272001R0164	144.70
20	S202M-B20	2CDS272001R0205	156.70	S202M-C20	2CDS272001R0204	144.70
25	S202M-B25	2CDS272001R0255	156.70	S202M-C25	2CDS272001R0254	144.70
32	S202M-B32	2CDS272001R0325	156.70	S202M-C32	2CDS272001R0324	144.70
40	S202M-B40	2CDS272001R0405	156.70	S202M-C40	2CDS272001R0404	144.70
50	S202M-B50	2CDS272001R0505	193.90	S202M-C50	2CDS272001R0504	173.50
63	S202M-B63	2CDS272001R0635	193.90	S202M-C63	2CDS272001R0634	173.50

System pro M compact®

Modular DIN Rail Component Products

S 200 M MCB

Standard : IEC/EN 60898, IEC/EN 60947-2
 : UL1077, CSA 22.2 No.235

Icn = 10kA

Voltage range:

1P : 230V ~ 240VAC – 50/60Hz

2P, 3P & 4P : 230V ~ 415VAC – 50/60Hz



1

3 Poles

Rating (A)	Model	B curve (3 ~ 5 In)		Model	C curve (5 ~ 10 In)	
		Order Code	List Price (RM)		Order Code	List Price (RM)
6	S203M-B6	2CDS273001R0065	214.90	S203M-C6	2CDS273001R0064	215.50
10	S203M-B10	2CDS273001R0105	214.90	S203M-C10	2CDS273001R0104	215.50
16	S203M-B16	2CDS273001R0165	214.90	S203M-C16	2CDS273001R0164	215.50
20	S203M-B20	2CDS273001R0205	214.90	S203M-C20	2CDS273001R0204	215.50
25	S203M-B25	2CDS273001R0255	214.90	S203M-C25	2CDS273001R0254	215.50
32	S203M-B32	2CDS273001R0325	214.90	S203M-C32	2CDS273001R0324	215.50
40	S203M-B40	2CDS273001R0405	214.90	S203M-C40	2CDS273001R0404	215.50
50	S203M-B50	2CDS273001R0505	255.10	S203M-C50	2CDS273001R0504	244.90
63	S203M-B63	2CDS273001R0635	255.10	S203M-C63	2CDS273001R0634	244.90

4 Poles

Rating (A)	Model	B curve (3 ~ 5 In)		Model	C curve (5 ~ 10 In)	
		Order Code	List Price (RM)		Order Code	List Price (RM)
6	S204M-B6	2CDS274001R0065	275.50	S204M-C6	2CDS274001R0064	255.10
10	S204M-B10	2CDS274001R0105	275.50	S204M-C10	2CDS274001R0104	255.10
16	S204M-B16	2CDS274001R0165	275.50	S204M-C16	2CDS274001R0164	255.10
20	S204M-B20	2CDS274001R0205	275.50	S204M-C20	2CDS274001R0204	255.10
25	S204M-B25	2CDS274001R0255	275.50	S204M-C25	2CDS274001R0254	255.10
32	S204M-B32	2CDS274001R0325	275.50	S204M-C32	2CDS274001R0324	255.10
40	S204M-B40	2CDS274001R0405	275.50	S204M-C40	2CDS274001R0404	255.10
50	S204M-B50	2CDS274001R0505	306.10	S204M-C50	2CDS274001R0504	275.50
63	S204M-B63	2CDS274001R0635	306.10	S204M-C63	2CDS274001R0634	275.50

System pro M compact®

Modular DIN Rail Component Products

S 200 P MCB

Standard : IEC/EN 60898, IEC/EN 60947-2
: UL1077, CSA 22.2 No.235

I_{cn} = 25kA for 0.5A ≤ I_n ≤ 25A

I_{cn} = 15kA for 32A ≤ I_n ≤ 63A

Voltage range:

1P : 230V ~ 240VAC – 50/60Hz

2P, 3P & 4P : 230V ~ 415VAC – 50/60Hz



1 Pole

Rating (A)	Model	B curve (3 ~ 5 In)		Model	C curve (5 ~ 10 In)	
		Order Code	List Price (RM)		Order Code	List Price (RM)
6	S201P-B6	2CDS281001R0065	112.30	S201P-C6	2CDS281001R0064	112.30
10	S201P-B10	2CDS281001R0105	112.30	S201P-C10	2CDS281001R0104	112.30
16	S201P-B16	2CDS281001R0165	112.30	S201P-C16	2CDS281001R0164	112.30
20	S201P-B20	2CDS281001R0205	112.30	S201P-C20	2CDS281001R0204	112.30
25	S201P-B25	2CDS281001R0255	112.30	S201P-C25	2CDS281001R0254	112.30
32	S201P-B32	2CDS281001R0325	112.30	S201P-C32	2CDS281001R0324	112.30
40	S201P-B40	2CDS281001R0405	112.30	S201P-C40	2CDS281001R0404	112.30
50	S201P-B50	2CDS281001R0505	132.70	S201P-C50	2CDS281001R0504	132.70
63	S201P-B63	2CDS281001R0635	132.70	S201P-C63	2CDS281001R0634	132.70

2 Poles

Rating (A)	Model	B curve (3 ~ 5 In)		Model	C curve (5 ~ 10 In)	
		Order Code	List Price (RM)		Order Code	List Price (RM)
6	S202P-B6	2CDS282001R0065	224.50	S202P-C6	2CDS282001R0064	224.50
10	S202P-B10	2CDS282001R0105	224.50	S202P-C10	2CDS282001R0104	224.50
16	S202P-B16	2CDS282001R0165	224.50	S202P-C16	2CDS282001R0164	224.50
20	S202P-B20	2CDS282001R0205	224.50	S202P-C20	2CDS282001R0204	224.50
25	S202P-B25	2CDS282001R0255	224.50	S202P-C25	2CDS282001R0254	224.50
32	S202P-B32	2CDS282001R0325	224.50	S202P-C32	2CDS282001R0324	224.50
40	S202P-B40	2CDS282001R0405	224.50	S202P-C40	2CDS282001R0404	224.50
50	S202P-B50	2CDS282001R0505	265.30	S202P-C50	2CDS282001R0504	265.30
63	S202P-B63	2CDS282001R0635	265.30	S202P-C63	2CDS282001R0634	265.30

System pro M compact®

Modular DIN Rail Component Products

1

S 200 P MCB

Standard : IEC/EN 60898, IEC/EN 60947-2
: UL1077, CSA 22.2 No.235

I_{cn} = 25kA for 0.5A ≤ I_n ≤ 25A

I_{cn} = 15kA for 32A ≤ I_n ≤ 63A

Voltage range:

1P : 230V ~ 240VAC – 50/60Hz

2P, 3P & 4P : 230V ~ 415VAC – 50/60Hz



3 Poles

Rating (A)	Model	B curve (3 ~ 5 In)		Model	C curve (5 ~ 10 In)	
		Order Code	List Price (RM)		Order Code	List Price (RM)
6	S203P-B6	2CDS283001R0065	336.70	S203P-C6	2CDS283001R0064	336.70
10	S203P-B10	2CDS283001R0105	336.70	S203P-C10	2CDS283001R0104	336.70
16	S203P-B16	2CDS283001R0165	336.70	S203P-C16	2CDS283001R0164	336.70
20	S203P-B20	2CDS283001R0205	336.70	S203P-C20	2CDS283001R0204	336.70
25	S203P-B25	2CDS283001R0255	336.70	S203P-C25	2CDS283001R0254	336.70
32	S203P-B32	2CDS283001R0325	336.70	S203P-C32	2CDS283001R0324	336.70
40	S203P-B40	2CDS283001R0405	336.70	S203P-C40	2CDS283001R0404	336.70
50	S203P-B50	2CDS283001R0505	377.60	S203P-C50	2CDS283001R0504	377.60
63	S203P-B63	2CDS283001R0635	377.60	S203P-C63	2CDS283001R0634	377.60

4 Poles

Rating (A)	Model	B curve (3 ~ 5 In)		Model	C curve (5 ~ 10 In)	
		Order Code	List Price (RM)		Order Code	List Price (RM)
6	S204P-B6	2CDS284001R0065	489.80	S204P-C6	2CDS284001R0064	489.80
10	S204P-B10	2CDS284001R0105	489.80	S204P-C10	2CDS284001R0104	489.80
16	S204P-B16	2CDS284001R0165	489.80	S204P-C16	2CDS284001R0164	489.80
20	S204P-B20	2CDS284001R0205	489.80	S204P-C20	2CDS284001R0204	489.80
25	S204P-B25	2CDS284001R0255	489.80	S204P-C25	2CDS284001R0254	489.80
32	S204P-B32	2CDS284001R0325	489.80	S204P-C32	2CDS284001R0324	489.80
40	S204P-B40	2CDS284001R0405	489.80	S204P-C40	2CDS284001R0404	489.80
50	S204P-B50	2CDS284001R0505	561.20	S204P-C50	2CDS284001R0504	561.20
63	S204P-B63	2CDS284001R0635	561.20	S204P-C63	2CDS284001R0634	561.20

System pro M compact®

Modular DIN Rail Component Products

FH 200 AC type RCCB

Standard: IEC 61008

Protection against the effect of sinusoidal alternating earth fault currents

Protection against indirect contacts and additional protection against direct (with $I_{\Delta n} = 30\text{mA}$) contacts



2 Poles

Sensitivity (mA)	Rating (A)	Model	Order Code	List Price (RM)
30	25	FH202 AC-25/0.03	2CSF202006R1250	260.90
	40	FH202 AC-40/0.03	2CSF202006R1400	205.20
	63	FH202 AC-63/0.03	2CSF202006R1630	278.40
100	25	FH202 AC-25/0.1	2CSF202006R2250	240.10
	40	FH202 AC-40/0.1	2CSF202006R2400	161.40
	63	FH202 AC-63/0.1	2CSF202006R2630	214.50
300	25	FH202 AC-25/0.3	2CSF202006R3250	260.80
	40	FH202 AC-40/0.3	2CSF202006R3400	233.30
	63	FH202 AC-63/0.3	2CSF202006R3630	305.10

4 Poles

Sensitivity (mA)	Rating (A)	Model	Order Code	List Price (RM)
30	25	FH204 AC-25/0.03	2CSF204006R1250	382.70
	40	FH204 AC-40/0.03	2CSF204006R1400	322.70
	63	FH204 AC-63/0.03	2CSF204006R1630	501.60
100	25	FH204 AC-25/0.1	2CSF204006R2250	452.30
	40	FH204 AC-40/0.1	2CSF204006R2400	315.50
	63	FH204 AC-63/0.1	2CSF204006R2630	412.10
300	25	FH204 AC-25/0.3	2CSF204006R3250	348.00
	40	FH204 AC-40/0.3	2CSF204006R3400	258.20
	63	FH204 AC-63/0.3	2CSF204006R3630	318.00

Auto Recloser

Motor operating, Automatic recloses RCCB when nuisance tripping or unwanted tripping happens

Direct connect to 230VAC

Reset time for counter of automatic reclosing attempts : 12 Seconds

Number of automatic reset attempts : 1 time

Suitable for F202 and FH202 RCCBs up to 63A (2 Poles RCCB only)



Type	Description	Order Code	List Price (RM)
F2C-ARH	For 30mA 2P RCCBs	2CSF200992R0005	799.30
F2C-ARH100	For 100mA 2P RCCBs	2CSF200990R0005	799.30
F2C-ARH-T	For 30mA 2P RCCBs with automatic test	2CSF200991R0005	999.20
F2C-ARH-T100	For 100mA 2P RCCBs with automatic test	2CSF200989R0005	999.20

System pro M compact®

Modular DIN Rail Component Products

1

F 200 AC type RCCB

Standard: IEC 61008

Protection against the effect of sinusoidal alternating earth fault currents

Protection against indirect contacts and additional protection against direct (with $I_{\Delta n} = 30\text{mA}$) contacts



2 Poles

Sensitivity (mA)	Rating (A)	Model	Order Code	List Price (RM)
10	25	F202 AC-25/0.01	2CSF202001R0250	347.10
	25	F202 AC-25/0.03	2CSF202005R1250	334.70
	40	F202 AC-40/0.03	2CSF202005R1400	292.40
	63	F202 AC-63/0.03	2CSF202005R1630	418.40
	80	F202 AC-80/0.03	2CSF202005R1800	476.20
30	100	F202 AC-100/0.03	2CSF202005R1900	748.40
	25	F202 AC-25/0.1	2CSF202005R2250	317.50
	40	F202 AC-40/0.1	2CSF202005R2400	303.40
100	63	F202 AC-63/0.1	2CSF202005R2630	395.50
	80	F202 AC-80/0.1	2CSF202005R2800	500.60
	100	F202 AC-100/0.1	2CSF202005R2900	603.70
300	25	F202 AC-25/0.3	2CSF202005R3250	334.70
	40	F202 AC-40/0.3	2CSF202005R3400	303.40
	63	F202 AC-63/0.3	2CSF202005R3630	395.50
	80	F202 AC-80/0.3	2CSF202005R3800	476.20
	100	F202 AC-100/0.3	2CSF202005R3900	575.10
500	80	F202 AC-80/0.5	2CSF202005R4800	476.20
	100	F202 AC-100/0.5	2CSF202005R4900	575.10

System pro M compact®

Modular DIN Rail Component Products

F 200 AC type RCCB

Standard: IEC 61008

Protection against the effect of sinusoidal alternating earth fault currents

Protection against indirect contacts and additional protection against direct (with $I_{\Delta n} = 30\text{mA}$) contacts



4 Poles

Sensitivity (mA)	Rating (A)	Model	Order Code	List Price (RM)
30	25	F204 AC-25/0.03	2CSF204005R1250	460.00
	40	F204 AC-40/0.03	2CSF204005R1400	460.00
	63	F204 AC-63/0.03	2CSF204005R1630	731.70
	80	F204 AC-80/0.03	2CSF204005R1800	748.40
	100	F204 AC-100/0.03	2CSF204005R1900	803.40
	125	F204 AC-125/0.03	2CSF204001R1950	4,669.10
100	25	F204 AC-25/0.1	2CSF204005R2250	460.00
	40	F204 AC-40/0.1	2CSF204005R2400	357.50
	63	F204 AC-63/0.1	2CSF204005R2630	511.00
	80	F204 AC-80/0.1	2CSF204005R2800	785.80
	100	F204 AC-100/0.1	2CSF204005R2900	779.50
	125	F204 AC-125/0.1	2CSF204001R2950	4,525.50
300	25	F204 AC-25/0.3	2CSF204005R3250	460.00
	40	F204 AC-40/0.3	2CSF204005R3400	376.20
	63	F204 AC-63/0.3	2CSF204005R3630	414.30
	80	F204 AC-80/0.3	2CSF204005R3800	748.40
	100	F204 AC-100/0.3	2CSF204005R3900	730.60
	125	F204 AC-125/0.3	2CSF204001R3950	3,591.40
500	80	F204 AC-80/0.5	2CSF204005R4800	748.40
	100	F204 AC-100/0.5	2CSF204005R4900	898.20
	125	F204 AC-125/0.5	2CSF204001R4950	3,591.40

System pro M compact®

Modular DIN Rail Component Products

1

F 200 AP-R (high immunity), A \square type RCCB

Standard: IEC 61008

Protection against the effects of sinusoidal alternating earth fault currents, providing the best compromise between safety and continuity in the service thanks to the resistance to unwanted tripping

Protection against indirect contacts and additional protection against direct (with $I\Delta n = 30\text{mA}$) contacts

Surge current resistance (wave 8/20) = 3000 A



2 Poles

Sensitivity (mA)	Rating (A)	Model	Order Code	List Price (RM)
30	25	F202 A-25/0.03 AP-R	2CSF202401R1250	468.40
	40	F202 A-40/0.03 AP-R	2CSF202401R1400	409.60
	63	F202 A-63/0.03 AP-R	2CSF202401R1630	584.90

4 Poles

Sensitivity (mA)	Rating (A)	Model	Order Code	List Price (RM)
30	25	F204 A-25/0.03 AP-R	2CSF204401R1250	643.80
	40	F204 A-40/0.03 AP-R	2CSF204401R1400	643.80
	63	F204 A-63/0.03 AP-R	2CSF204401R1630	1,024.10

System pro M compact®

Modular DIN Rail Component Products

DS 201 AC type, C characteristic RCBO

Standard: IEC/EN 61009

I_{cn} = 6kA

Protect of end user single-phase circuits against overload and short-circuit currents

Protection against the effects of sinusoidal alternating earth fault currents

Protection against indirect contact and additional protection against direct contact (with I_{Δn} = 30mA)

Voltage-independent RCBO



1P + N

Sensitivity (mA)	Rating (A)	Model	Order Code	List Price (RM)
30	6	DS201 C6 AC30	2CSR255040R1064	751.40
	10	DS201 C10 AC30	2CSR255040R1104	751.40
	13	DS201 C13 AC30	2CSR255040R1134	751.40
	16	DS201 C16 AC30	2CSR255040R1164	751.40
	20	DS201 C20 AC30	2CSR255040R1204	751.40
	25	DS201 C25 AC30	2CSR255040R1254	751.40
	32	DS201 C32 AC30	2CSR255040R1324	751.40
	40	DS201 C40 AC30	2CSR255040R1404	751.40
100	6	DS201 C6 AC100	2CSR255040R2064	714.90
	10	DS201 C10 AC100	2CSR255040R2104	714.90
	13	DS201 C13 AC100	2CSR255040R2134	714.90
	16	DS201 C16 AC100	2CSR255040R2164	714.90
	20	DS201 C20 AC100	2CSR255040R2204	714.90
	25	DS201 C25 AC100	2CSR255040R2254	714.90
	32	DS201 C32 AC100	2CSR255040R2324	714.90
	40	DS201 C40 AC100	2CSR255040R2404	714.90
300	6	DS201 C6 AC300	2CSR255040R3064	789.90
	10	DS201 C10 AC300	2CSR255040R3104	789.90
	13	DS201 C13 AC300	2CSR255040R3134	789.90
	16	DS201 C16 AC300	2CSR255040R3164	789.90
	20	DS201 C20 AC300	2CSR255040R3204	789.90
	25	DS201 C25 AC300	2CSR255040R3254	789.90
	32	DS201 C32 AC300	2CSR255040R3324	789.90
	40	DS201 C40 AC300	2CSR255040R3404	789.90

System pro M compact®

Modular DIN Rail Component Products

Accessories for S 200 MCB, F 200 RCCB & others

Signal/auxiliary contacts, for S 200 MCB, F 200 RCCB, right fitting
With selector between indication of the position of the device's contacts,
and signalling of fault



1

Type	Model	Order Code	List Price (RM)
Signal / auxiliary	S2C-S/H6R	2CDS200922R0001	120.00
Auxiliary	S2C-H6R	2CDS200912R0001	101.90

Auxiliary contacts for S 200, S 200 M, S 200 P, left fitting

Type	Model	Order Code	List Price (RM)
1NO/NC	S2C-H11L	2CDS200936R0001	101.90
2NO	S2C-H20L	2CDS200936R0002	101.90
2NC	S2C-H02L	2CDS200936R0003	101.90

Auxiliary contacts for S 200, S 200 M, S 200 P, bottom fitting

Type	Model	Order Code	List Price (RM)
1NC	S2C-H01	2CDS200970R0001	79.60
1NO	S2C-H10	2CDS200970R0002	79.60

Shunt trips: Remote opening of the device when a voltage is applied. For S 200, S 200 M, S 200 P

Type	Model	Order Code	List Price (RM)
12 – 60 VAC/VDC	S2C-A1	2CDS200909R0001	127.30
110 – 415 VAC & 110 – 250 VDC	S2C-A2	2CDS200909R0002	127.30

Motor Operating Devices, for remote control opening and closing. Suitable for S200 MCBs and F200 RCCBs

Type	Model	Order Code	List Price (RM)
1P S200 MCB	S2C-CM1	2CSS201997R0013	3,744.70
2P & 3P S200 MCB	S2C-CM2/3	2CSS203997R0013	3,744.70
4P S200 MCB	S2C-CM4	2CSS204997R0013	3,744.70

System pro M compact®

Modular DIN Rail Component Products

Combination of auxiliary elements with

S200, S200M, S200P, DDA200 + S200 or DS200

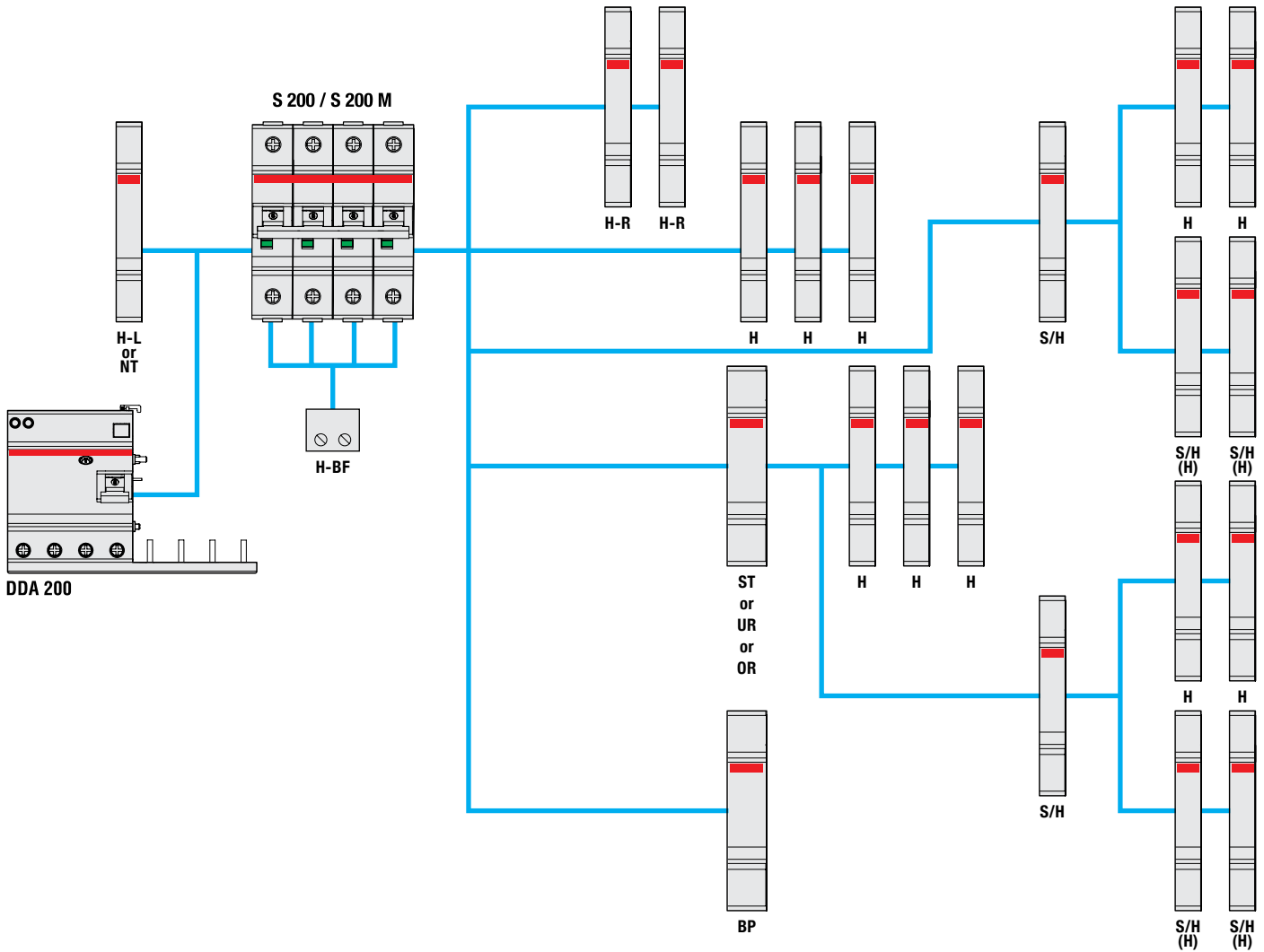

H	Auxiliary contact	S2C-H6R
H-R	Auxiliary contact	S2C-H6-...R
S/H	Signal/Auxiliary contact	S2C-S/H6R
S/H (H)	Signal/Auxiliary contact used as auxiliary contact	S2C-S/H6R
ST	Shunt trip for S 200 MCB	S2C-A...
UR	Undervoltage release	S2C-UA
OR	Overvoltage release	S2C-OVP
H-L	Auxiliary contact for S 200 MCBs to be mounted on the left	S2C-H...L
H-BF	Auxiliary contact for MCBs bottom fitting (1 for each pole of MCB)	S2C-H01/S2C-H10
BP	Mechanical tripping device	S2C-BP
NT	Switched neutral	S2C-Nt

In case of using rotary operating mechanism S2C-DH (only right side mountable) the auxiliary devices left side and bottom fitting auxiliary contact could be used.

System pro M compact®

Modular DIN Rail Component Products

Combination of auxiliary elements with F200

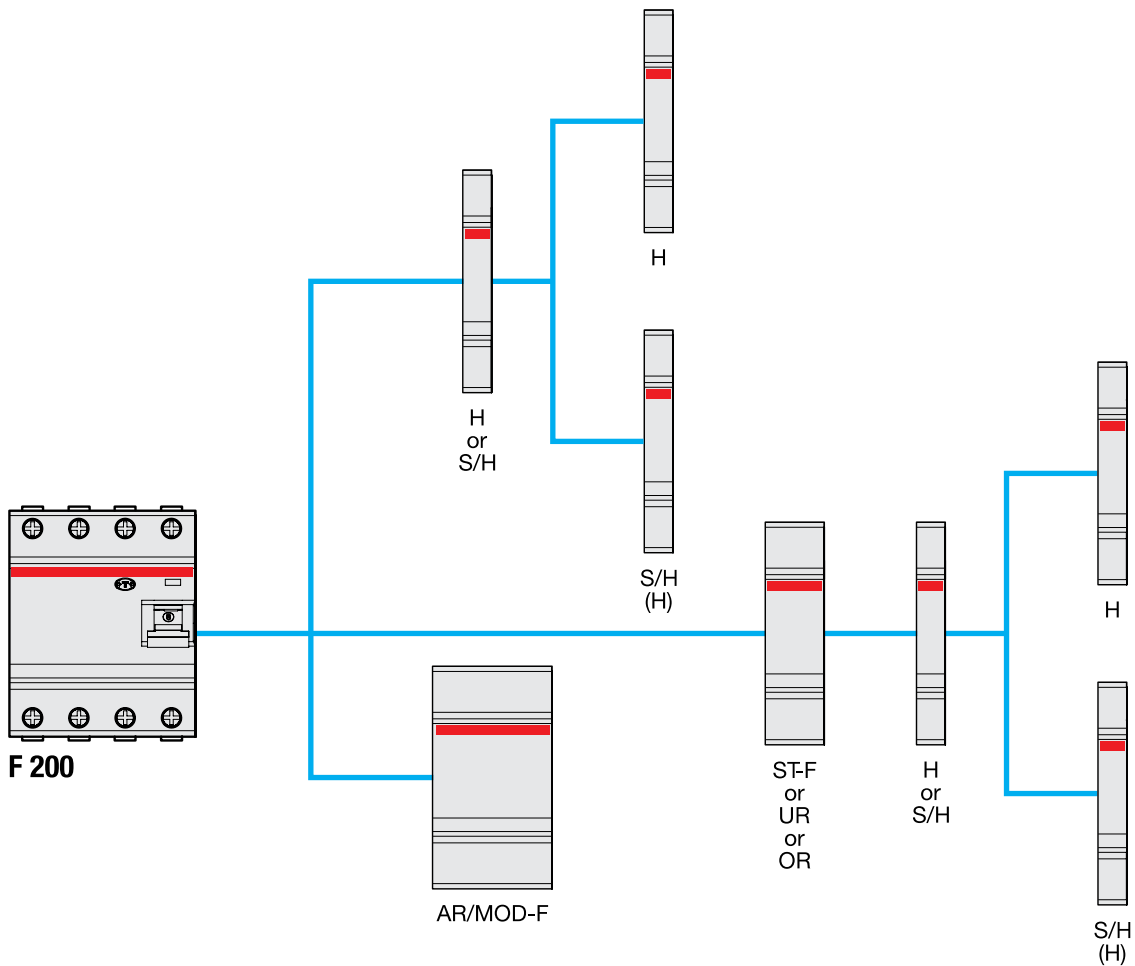

H	Auxiliary contact	S2C-H6R
S/H	Signal/Auxiliary contact	S2C-S/H6R
S/H (H)	Signal/Auxiliary contact used as auxiliary contact	S2C-S/H6R
UR	Undervoltage release	S2C-UA
OR	Overvoltage release	S2C-OVP
AR	Auto reclosing unit	F2C-ARI
MOD-F	Motor operating device	F2C-CM
ST-F	Shunt trip for F 200 RCCB	F2C-A

System pro M compact®

Modular DIN Rail Component Products

Combination of auxiliary elements for DS201, DS202C

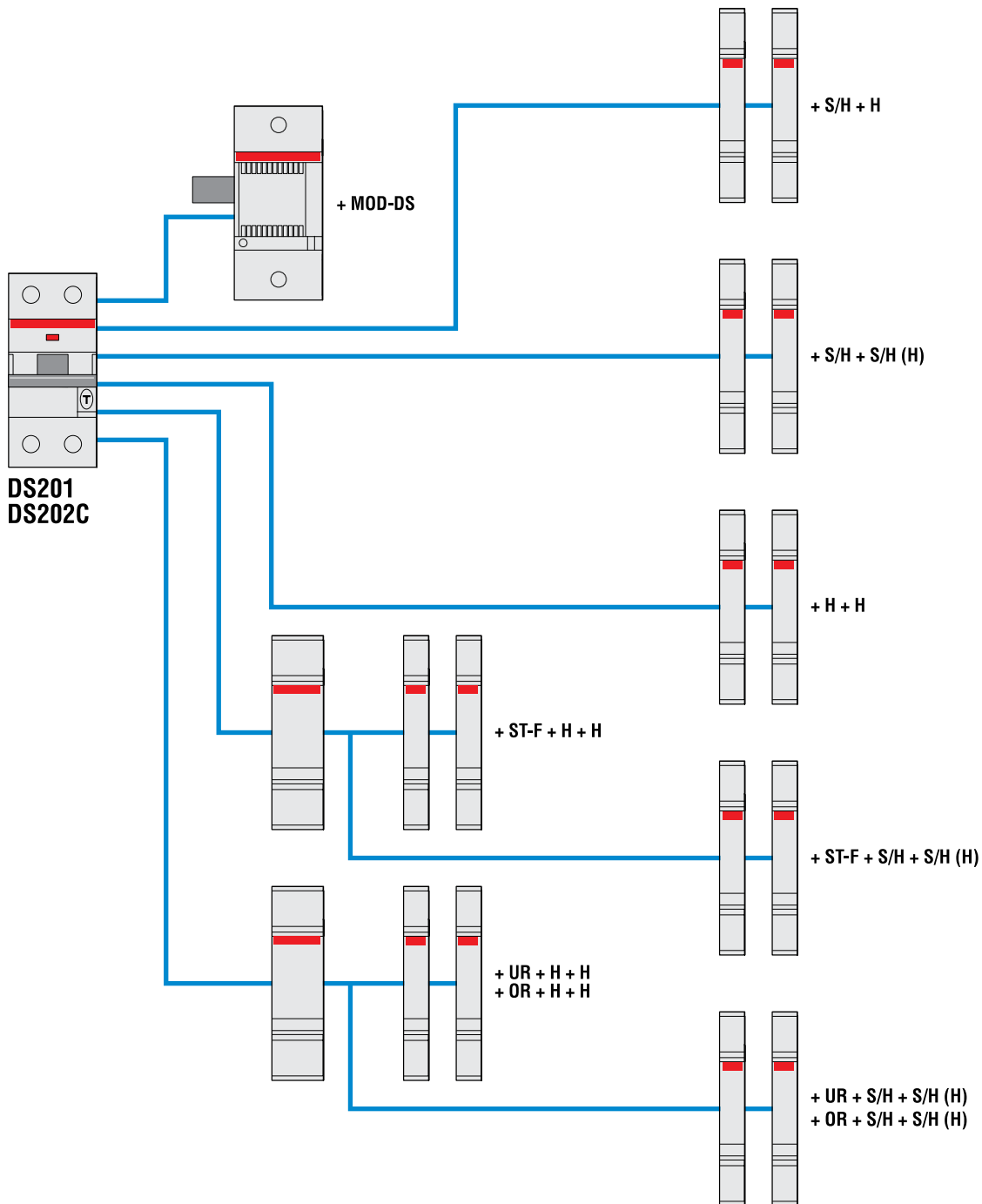

H	Auxiliary contact	S2C-H6R
S/H	Signal/Auxiliary contact	S2C-S/H6R
S/H (H)	Signal/Auxiliary contact used as auxiliary contact	S2C-S/H6R
ST-F	Shunt trip for F 200 RCCB	F2C-A
UR	Undervoltage release	S2C-UA
OR	Overvoltage release	S2C-OVP
MOD-DS	Motor operating device	DS2C-CM

System pro M compact®

Modular DIN Rail Component Products

Surge protective devices SPD

OVR range: Type 1, Type 1 + 2

Protection against overvoltages and impulse currents
(such as switching and lighting surges)
Limit overvoltage to a level acceptable by the equipment to be protected
and divert surge currents

Type 1 :Surge arrester designed to run-off energy caused by an overvoltage
comparable to that of a direct lighting (10/350 wave) Class 1
:Surge arresters installed at main switch board

Full Mode Protection (Common Mode + Differential Mode)
(TT/TN-S)
Non Pluggable Type



1

Type	Poles	limp/pole (10/350)	Model	Order Code	List Price (RM)
Type 1	1P+N	25kA	OVR T1 1N 25 255	2CTB815101R1500	3,906.70
			OVR T1 1N 25 255-TS	2CTB815101R1000	4,590.20
	3P+N	25kA	OVR T1 3N 25 255	2CTB815101R1600	7,354.60
			OVR T1 3N 25 255-TS	2CTB815101R0700	7,922.60

Pluggable Type

Type	Poles	limp/pole (10/350)	Model	Order Code	List Price (RM)
Type 1 + 2	1P+N	12kA	OVR T1-T2 1N 12.5-275s P QS	2CTB815710R1300	3,780.60
			OVR T1-T2 1N 12.5-275s P TS QS	2CTB815710R0100	4,224.40
	3P+N	12kA	OVR T1-T2 3N 12.5-275s P QS	2CTB815710R1900	6,257.10
			OVR T1-T2 3N 12.5-275s P TS QS	2CTB815710R0700	7,195.80

Cartridges

Type	limp/pole (10/350)	Model	Order Code	List Price (RM)
Type 1+2	12.5kA	OVR T1-T2 12.5-275s C QS	2CTB815710R2600	855.90
	50kA (Neutral)	OVR T1-T2 N 50-275s C QS	2CTB815710R2700	1,029.70

*QS – Quick Safe Technology
*P – Pluggable Device
*s – Reserved Protection
*TS – Auxiliary contact
*C – Cartridge

System pro M compact®

Modular DIN Rail Component Products

Surge protective devices SPD OVR range: Type 2, Type 2 + 3

Type 2 : Surge arrester designed to run-off energy caused by an overvoltage comparable to that of an indirect lighting (8/20 wave) Class II
: Surge arresters installed at sub-switch board and distribution board



Full Mode Protection (Common Mode + Differential Mode)
(TT/TN-S)

Type	Poles	I _{max} (8/20)	Model	Order Code	List Price (RM)
Type 2	1P+N	80kA	OVR T2 1N 80-275s P QS	2CTB815708R1400	1,406.10
			OVR T2 1N 80-275s P TS QS	2CTB815708R0200	1,654.50
	3P+N	40kA	OVR T2 1N 40-275 P QS	2CTB803972R1100	633.00
			OVR T2 1N 40-275 P TS QS	2CTB803972R0500	1,082.30
		80kA	OVR T2 3N 80-275s P QS	2CTB815708R2000	2,148.20
			OVR T2 3N 80-275s P TS QS	2CTB815708R0800	2,282.20
Type 2 + 3	1P+N	20kA	OVR T2-T3 1N 20-275 P QS	2CTB803972R1200	745.30
			OVR T2-T3 1N 20-275 P TS QS	2CTB803972R1300	1,271.40
	3P+N	40kA	OVR T2 3N 40-275 P QS	2CTB803973R1100	1,053.50
			OVR T2 3N 40-275 P TS QS	2CTB803973R0500	1,173.10
		20kA	OVR T2-T3 3N 20-275 P QS	2CTB803973R1200	1,334.00
			OVR T2-T3 3N 20-275 P TS QS	2CTB803973R1600	2,276.50

Full Mode Protection (Common Mode + Differential Mode) 7 Module MOV Protection

Type	Protection Mode	I _{max} (8/20)	Model	Ordercode	List Price (RM)
Type 2	L-L / L-N / L-PE / N-PE	40kA	OVR T2 4L+3L 40-275 P QS	2CTB803873R5800	2,075.50

Cartridges

Type	I _{max} (8/20)	Model	Order Code	List Price (RM)
Type 2	80kA	OVR T2 80-275s C QS	2CTB815708R2600	513.40
	40kA	OVR T2 40-275 C QS	2CTB803876R1000	370.20
	80kA(Neutral)	OVR T2 N 80-275s C QS	2CTB815708R2800	916.10
Type 2 + 3	20kA	OVR T2-T3 20-275 C QS	2CTB803876R1200	274.30
	80kA(Neutral)	OVR T2-T3 N 80-275 C QS	2CTB803876R0000	618.40

*QS – Quick Safe Technology
*P – Pluggable Device
*s – Reserved Protection
*TS – Auxiliary contact
*C – Cartridge

System pro M compact®

Modular DIN Rail Component Products

1

SHD200 Switch Disconnecter

Standard: EN 60947-3

Isolator for panel installation onto DIN rail acc. To DIN EN 60715

Rated Voltage: 240/415 VAC – 50/60Hz



1 Pole

Rating (A)	Model	Order Code	List Price (RM)
16	SHD201/16	2CDD271111R0016	36.40
25	SHD201/25	2CDD271111R0025	36.40
32	SHD201/32	2CDD271111R0032	39.80
40	SHD201/40	2CDD271111R0040	39.80
45	SHD201/50	2CDD271111R0050	51.00
63	SHD201/63	2CDD271111R0063	51.00

2 Poles

Rating (A)	Model	Order Code	List Price (RM)
16	SHD202/16	2CDD272111R0016	58.00
25	SHD202/25	2CDD272111R0025	58.00
32	SHD202/32	2CDD272111R0032	63.60
40	SHD202/40	2CDD272111R0040	63.60
45	SHD202/50	2CDD272111R0050	75.80
63	SHD202/63	2CDD272111R0063	75.80

3 Poles

Rating (A)	Model	Order Code	List Price (RM)
16	SHD203/16	2CDD273111R0016	77.30
25	SHD203/25	2CDD273111R0025	77.30
32	SHD203/32	2CDD273111R0032	96.30
40	SHD203/40	2CDD273111R0040	96.30
45	SHD203/50	2CDD273111R0050	117.10
63	SHD203/63	2CDD273111R0063	117.10

4 Poles

Rating (A)	Model	Order Code	List Price (RM)
16	SHD204/16	2CDD274111R0016	119.20
25	SHD204/25	2CDD274111R0025	119.20
32	SHD204/32	2CDD274111R0032	125.20
40	SHD204/40	2CDD274111R0040	125.20
45	SHD204/50	2CDD274111R0050	147.30
63	SHD204/63	2CDD274111R0063	147.30

System pro M compact®

Modular DIN Rail Component Products

SD200 Switch Disconnecter

Standard: EN 60947-3

Isolator for panel installation onto DIN rail acc. To DIN EN 60715

Rated Voltage: 240/415 VAC – 50/60Hz

Compatible to System pro M accessories



1 Pole

Rating (A)	Model	Order Code	List Price (RM)
16	SD201/16	2CDD281101R0016	40.00
25	SD201/25	2CDD281101R0025	40.00
32	SD201/32	2CDD281101R0032	43.80
40	SD201/40	2CDD281101R0040	43.80
45	SD201/50	2CDD281101R0050	56.10
63	SD201/63	2CDD281101R0063	56.10

2 Poles

Rating (A)	Model	Order Code	List Price (RM)
16	SD202/16	2CDD282101R0016	63.70
25	SD202/25	2CDD282101R0025	63.70
32	SD202/32	2CDD282101R0032	70.00
40	SD202/40	2CDD282101R0040	70.00
45	SD202/50	2CDD282101R0050	83.30
63	SD202/63	2CDD282101R0063	83.30

3 Poles

Rating (A)	Model	Order Code	List Price (RM)
16	SD203/16	2CDD283101R0016	85.00
25	SD203/25	2CDD283101R0025	85.00
32	SD203/32	2CDD283101R0032	106.00
40	SD203/40	2CDD283101R0040	106.00
45	SD203/50	2CDD283101R0050	128.90
63	SD203/63	2CDD283101R0063	128.90

4 Poles

Rating (A)	Model	Order Code	List Price (RM)
16	SD204/16	2CDD284101R0016	131.10
25	SD204/25	2CDD284101R0025	131.10
32	SD204/32	2CDD284101R0032	137.70
40	SD204/40	2CDD284101R0040	137.70
45	SD204/50	2CDD284101R0050	162.10
63	SD204/63	2CDD284101R0063	162.10

System pro M compact®

Modular DIN Rail Component Products

1

Fuse Disconnectors

Switching circuits under load, providing protection against short circuits and overloads
 Rated duty: AC22B



Pole	Modules	Rating (A)	Description	Order Code	List Price (RM)
1	1	32	E91/32	2CSM200923R1801	20.60
3	3	32	E93/32	2CSM204753R1801	75.00

E 9F PV Cylindrical Fuses

The E 9F gG cylindrical fuses, coupled with E 90 fuse disconnectors, are the ideal solution for protection against overload and short-circuit. They feature a fast tripping curve that is ideal for protecting electronic devices, transformers and electric cables.

Fuse size : 10.3 x 38 mm

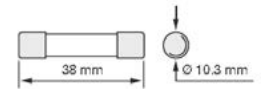

Rated current (A)	Breaking Capacity	Model	Order code	List price (RM)
0.5	120kA	E9F10GG05	2CSM277333R1801	27.10
1		E9F10GG1	2CSM277113R1801	14.10
2		E9F10GG2	2CSM258723R1801	14.10
4		E9F10GG4	2CSM257543R1801	14.10
6		E9F10GG6	2CSM256363R1801	14.10
8		E9F10GG8	2CSM258633R1801	14.10
10		E9F10GG10	2CSM257453R1801	14.10
12		E9F10GG12	2CSM256273R1801	14.10
16		E9F10GG16	2CSM277543R1801	14.10
20		E9F10GG20	2CSM277323R1801	14.10
25		E9F10GG25	2CSM277103R1801	14.10
32		E9F10GG32	2CSM258713R1801	14.10

System pro M compact®

Modular DIN Rail Component Products

Electro-mechanical Time Switches

AT72 electro-mechanical time switches offer a comfortable and reliable solution to control lighting, heating or ventilation systems in commercial and residential applications. Thanks to the convenient accessibility of the dial on the front, AT72 time switches ensure precise programming for a maximum of safety and reliability. Standards : EN 60730-1, EN60730-2-7
IP 30, Panel/Wall Mount, 72 Hour Power Reserve



Contact	Type	Version	Rated Voltage	Order Code	List Price (RM)
1 NO/1 NC	AT72e-R	Daily 24 hours time switch, with running reserve	230 AC ± 10%	2CSM231265R0601	290.00

ELR: Front Panel Residual Current Relays

Front panel residual current relays are electronic devices used in combination with an external toroidal transformer
Dimension: 96 mm X 96 mm
Sensitivity adjustment I_{Δn}: 0.03 to 30 A
Tripping time adjustments Δt: from 0 to 5 sec
Standards: IEC 60947-2



Operating Voltage	No Contact	Features	No Contact	Order Code	List Price (RM)
110-230-400 V a.c.	1	Status LEDs, Autoreset	ELR96	2CSG152130R1202	975.10
110-230-400 V a.c.	2	Status LEDs, Alarm LED, Digital Display, Autoreset, Alarm, Fail Safe, Remote Reset, Display Logic	ELR96PD	2CSG152436R1202	1,218.40

Toroidal transformers

TR Series



Internal Diameter (mm)	Max rated current (A)	Min measurable current (mA)	Type	Order Code	List Price (RM)
35	75	30	TR 1	2CSG035100R1211	359.70
60	85	30	TR 2	2CSG060100R1211	409.40
80	160	100	TR 3	2CSG080100R1211	570.40
110	250	100	TR 4	2CSG110100R1211	706.50
160	400	300	TR 160	2CSG160100R1211	1,188.20

System pro M compact®

Modular DIN Rail Component Products

1

Digital Power Meter M2M LV

Measurement and advanced analysis of electrical parameters such as voltage, current, frequency, energy and power factor



Front mount and 96X96

Type	Description	Protocol	Serial Port	Order Code	List Price (RM)
M2M LV	2 digital outputs	–	–	2CSG299943R4052	2,557.80
M2M LV Modbus	2 digital outputs	Modbus RTU	RS-485	2CSG296992R4052	2,896.70

Electricity Meters

Meters for single phase and three phase metering, active energy measurement



Din Rail mount

Type	Rating (A)	Communication	Description	Order Code	List Price (RM)
Single phase, direct connect	40	–	C11 110-100	2CMA100014R1000	613.50
Single phase, direct connect	65	–	B21 111-100	2CMA100149R1000	1,022.10
Single phase, direct connect	65	RS-485	B21 112-100	2CMA100150R1000	1,362.10
Three phase, direct connect	65	–	B23 111-100	2CMA100163R1000	1,635.50
Three phase, direct connect	65	RS-485	B23 112-100	2CMA100164R1000	1,874.60
Three phase, CT connect	6	–	B24 111-100	2CMA100177R1000	1,635.50
Three phase, CT connect	6	RS-485	B24 112-100	2CMA100178R1000	1,874.60

System pro M compact®

Modular DIN Rail Component Products

Distribution Boards (DB) / Consumer Units

Distribution Boards (DB) for Consumer Units

Complete offer on flush/wall mounted distribution board
 Complete offer up to 72 modules
 IP41 protection, self-extinguishing thermoplastic material
 Resistant to abnormal heat (glow wire test 650°C)



MISTRAL series

Mounting type	No. of rows	No. of modules	Front cover type	Order Code	List Price (RM)
Flush	1	8	Transparent	1SLM004100A1202	88.80
	1	12	Transparent	1SLM004100A1203	124.00
	2	24	Transparent	1SLM004100A1205	216.00
	3	36	Transparent	1SLM004100A1207	338.90
	4	48	Transparent	1SLM004100A1208	431.90
	1	18	Transparent	1SLM004100A1204	186.00
	2	36	Transparent	1SLM004100A1206	338.90
	3	54	Transparent	1SLM004100A1209	598.60
	4	72	Transparent	1SLM004100A1210	677.70
	1	8	Opaque	1SLM004100A1102	100.50
	1	12	Opaque	1SLM004100A1103	134.70
	2	24	Opaque	1SLM004100A1105	230.90
	3	36	Opaque	1SLM004100A1107	342.10
	4	48	Opaque	1SLM004100A1108	461.80
	1	18	Opaque	1SLM004100A1104	202.10
	2	36	Opaque	1SLM004100A1106	342.10
	3	54	Opaque	1SLM004100A1109	601.80
	4	72	Opaque	1SLM004100A1110	684.10
Wall	1	8	Transparent	1SPE007717F0320	88.80
	1	12	Transparent	1SPE007717F0420	124.00
	2	24	Transparent	1SPE007717F0520	216.00
	3	36	Transparent	1SPE007717F0620	338.90
	4	48	Transparent	1SPE007717F0720	431.90
	1	18	Transparent	1SPE007717F0820	186.00
	2	36	Transparent	1SPE007717F0920	338.90
	3	54	Transparent	1SPE007717F1020	598.60
	4	72	Transparent	1SPE007717F1120	677.70
	1	8	Opaque	1SPE007717F0310	100.50
	1	12	Opaque	1SPE007717F0410	134.70
	2	24	Opaque	1SPE007717F0510	230.90
	3	36	Opaque	1SPE007717F0610	342.10
	4	48	Opaque	1SPE007717F0710	461.80
	1	18	Opaque	1SPE007717F0810	202.10
	2	36	Opaque	1SPE007717F0910	342.10
	3	54	Opaque	1SPE007717F1010	601.80
	4	72	Opaque	1SPE007717F1110	684.10

*All Distribution Boards are supplied without Terminal Bar

System pro M compact®

Modular DIN Rail Component Products

Distribution Boards (DB) / Consumer Units

Distribution Boards (DB) for Consumer Units

Built in full metal, the wall mounting switchboards of the System Pro E MICAL series are available in 10 different sizes. 2 different widths (13 or 18 modules) and 5 different heights allow to manage up to 5 rows. Comes with back knockout that gives ample space for the internal wiring. Combine with smart doors with reversible hinges that ensure maximum flexibility especially for residential installation. The doors, equipped with a snap closure mechanism, open to 120° and offer easy access to all the internal equipment.



MICAL Series

No. of Rows	No. of modules	Order code	Description	List Price (RM)
1	13	1SKM990000R1301	MICAL Metal Enclosure 13 Modules 1 Row	235.00
2	26	1SKM990000R1302	MICAL Metal Enclosure 13 Modules 2 Rows	310.00
3	39	1SKM990000R1303	MICAL Metal Enclosure 13 Modules 3 Rows	405.00
4	52	1SKM990000R1304	MICAL Metal Enclosure 13 Modules 4 Rows	495.00
5	65	1SKM990000R1305	MICAL Metal Enclosure 13 Modules 5 Rows	625.00
1	18	1SKM990000R1801	MICAL Metal Enclosure 18 Modules 1 Row	235.00
2	36	1SKM990000R1802	MICAL Metal Enclosure 18 Modules 2 Rows	310.00
3	54	1SKM990000R1803	MICAL Metal Enclosure 18 Modules 3 Rows	405.00
4	72	1SKM990000R1804	MICAL Metal Enclosure 18 Modules 4 Rows	495.00
5	90	1SKM990000R1805	MICAL Metal Enclosure 18 Modules 5 Rows	625.00

*All Distribution Boards are supplied without Terminal Bar

Terminal Bar

No. of Enclosure Rows	No. of Terminal Bars	Order code	Description	List Price / Unit (RM)	Total Price (RM)
1	2	1SPY001742D0123	S21 Terminal Bar	12.90	25.80
2	4	1SPY001742D0123	S21 Terminal Bar	12.90	51.60
3	6	1SPY001742D0123	S21 Terminal Bar	12.90	77.40
4	8	1SPY001742D0123	S21 Terminal Bar	12.90	103.20
5	10	1SPY001742D0123	S21 Terminal Bar	12.90	129.00

A series of horizontal dotted lines for writing.

Moulded Case Circuit Breakers (MCCB)



Moulded Case Circuit Breakers (MCCB)

Formula MCCB Selection Table



Ics = 50% or 25% Icu

Rated Current	Icu = Rated ultimate short-circuit breaking capacity				
	10kA	16kA	25kA	36kA	50kA
16A	A1A 125	A1B 125	A1C 125	A1N 125	–
20A	A1A 125	A1B 125	A1C 125	A1N 125	–
25A	A1A 125	A1B 125	A1C 125	A1N 125	–
32A	A1A 125	A1B 125	A1C 125	A1N 125	–
40A	A1A 125	A1B 125	A1C 125	A1N 125	–
50A	A1A 125	A1B 125	A1C 125	A1N 125	–
63A	A1A 125	A1B 125	A1C 125	A1N 125	–
80A	A1A 125	A1B 125	A1C 125	A1N 125	–
100A	A1A 125	A1B 125	A1C 125	A1N 125	–
125A	–	A2B 250	A2C 250	A2N 250	–
160A	–	A2B 250	A2C 250	A2N 250	–
200A	–	A2B 250	A2C 250	A2N 250	–
250A	–	A2B 250	A2C 250	A2N 250	–
320A	–	–	–	A3N 400	A3S 400
400A	–	–	–	A3N 400	A3S 400
500A	–	–	–	A3N 630	A3S 630
630A	–	–	–	A3N 630	A3S 630

Ics = Rated service short-circuit breaking capacity

Ics = 50% Icu

Ics = 25% Icu

Example: For A2C 250
Icu = 25kA, Ics = 50% Icu
Therefore, Ics = 12.5kA

Moulded Case Circuit Breakers (MCCB)

Tmax MCCB Selection Table



2

Ics = 100% Icu

Rated Current	Icu = Rated ultimate short-circuit breaking capacity							
	16kA	25kA	36kA	50kA	70kA	85kA	100kA	120kA
16A	XT1B 160	–	XT2N 160	XT2S 160	XT2H 160	On Request	–	–
20A	XT1B 160	–	XT2N 160	XT2S 160	XT2H 160	On Request	–	On Request
25A	XT1B 160	XT1C 160	XT2N 160	XT2S 160	XT2H 160	On Request	–	–
32A	XT1B 160	XT1C 160	XT2N 160	XT2S 160	XT2H 160	On Request	–	On Request
40A	XT1B 160	XT1C 160	XT2N 160	XT2S 160	XT2H 160	On Request	–	–
50A	XT1B 160	XT1C 160	XT2N 160	XT2S 160	XT2H 160	On Request	–	On Request
63A	XT1B 160	XT1C 160	XT2N 160	XT2S 160	XT2H 160	On Request	–	–
80A	XT1B 160	XT1C 160	XT2N 160	XT2S 160	XT2H 160	On Request	–	On Request
100A	XT1B 160	XT1C 160	XT2N 160	XT2S 160	XT2H 160	On Request	–	On Request
125A	XT1B 160	XT1C 160	XT2N 160	XT2S 160	XT2H 160	On Request	–	On Request
160A	XT1B 160	XT1C 160	XT2N 160	XT2S 160	XT2H 160	On Request	–	On Request
200A	–	–	XT4N 250	XT4S 250	XT4H 250	–	–	On Request
250A	–	–	XT4N 250	XT4S 250	XT4H 250	–	–	On Request
320A	–	–	T4N 320	T4S 320	T4H 320	–	–	On Request
400A	–	–	T5N 400	T5S 400	T5H 400	–	–	On Request
500A	–	–	T5N 630	T5S 500	T5H 630	–	–	On Request
630A	–	–	T5N 630	T5S 630	T5H 630	–	On Request	On Request
800A	–	–	T6N 800	T6S 800	T6H 800	–	On Request	On Request
1000A	–	–	–	T6S 1000	T6H 1000	–	On Request	On Request
1250A	–	–	–	T7S 1250	T7H 1250	–	–	On Request
1600A	–	–	–	T7S 1600	T7H 1600	–	–	On Request

Moulded Case Circuit Breakers (MCCB)

Formula Series 1 pole – A1N, A2N 25kA Icu @ 240VAC



In	Model	Ics (% of Icu)	Trip Unit	Order Code	List Price (RM)
				1 Pole	
20A	A1N 125	50%	TMF	1SDA066686R1	240.00
25A	A1N 125	50%	TMF	1SDA066687R1	240.00
32A	A1N 125	50%	TMF	1SDA068755R1	240.00
40A	A1N 125	50%	TMF	1SDA066689R1	240.00
50A	A1N 125	50%	TMF	1SDA066690R1	240.00
63A	A1N 125	50%	TMF	1SDA068766R1	240.00
80A	A1N 125	50%	TMF	1SDA066693R1	240.00
100A	A1N 125	50%	TMF	1SDA066695R1	240.00
125A	A2N 250	50%	TMF	1SDA066769R1	492.00
160A	A2N 250	50%	TMF	1SDA066770R1	492.00
200A	A2N 250	50%	TMF	1SDA066772R1	739.00
250A	A2N 250	50%	TMF	1SDA066774R1	775.00

TMF = Fixed Thermal & Magnetic Threshold



Formula Series 2 poles – A1N, A2N 50kA Icu @ 240VAC

In	Model	Ics (% of Icu)	Trip Unit	Order Code	List Price (RM)
				2 Poles	
16A	A1N 125	50%	TMF	1SDA068790R1	261.00
20A	A1N 125	50%	TMF	1SDA066497R1	261.00
25A	A1N 125	50%	TMF	1SDA066498R1	261.00
32A	A1N 125	50%	TMF	1SDA068756R1	261.00
40A	A1N 125	50%	TMF	1SDA066500R1	261.00
50A	A1N 125	50%	TMF	1SDA066501R1	261.00
63A	A1N 125	50%	TMF	1SDA068767R1	261.00
80A	A1N 125	50%	TMF	1SDA066504R1	261.00
100A	A1N 125	50%	TMF	1SDA066506R1	261.00
125A	A2N 250	50%	TMF	1SDA066542R1	535.00
160A	A2N 250	50%	TMF	1SDA066543R1	535.00
200A	A2N 250	50%	TMF	1SDA066545R1	824.00
250A	A2N 250	50%	TMF	1SDA066547R1	860.00

TMF = Fixed Thermal & Magnetic Threshold

Moulded Case Circuit Breakers (MCCB)

Formula Series – A1A

10kA Icu @ 415VAC



2

In	Model	Ics (% of Icu)	Trip Unit	3 Poles		4 Poles	
				Order Code	List Price (RM)	Order Code	List Price (RM)
16A	A1A 125	50%	TMF	1SDA068746R1	272.00	1SDA068750R1	375.00
20A	A1A 125	50%	TMF	1SDA066511R1	272.00	1SDA066525R1	375.00
25A	A1A 125	50%	TMF	1SDA066512R1	272.00	1SDA066526R1	375.00
32A	A1A 125	50%	TMF	1SDA068757R1	272.00	1SDA068761R1	375.00
40A	A1A 125	50%	TMF	1SDA066514R1	272.00	1SDA066528R1	375.00
50A	A1A 125	50%	TMF	1SDA066515R1	272.00	1SDA066529R1	375.00
63A	A1A 125	50%	TMF	1SDA068768R1	272.00	1SDA068772R1	375.00
80A	A1A 125	50%	TMF	1SDA066518R1	272.00	1SDA066532R1	375.00
100A	A1A 125	50%	TMF	1SDA066520R1	272.00	1SDA066534R1	375.00

TMF = Fixed Thermal & Magnetic Threshold



Formula Series – A1B, A2B

18kA Icu @ 415VAC

In	Model	Ics (% of Icu)	Trip Unit	3 Poles		4 Poles	
				Order Code	List Price (RM)	Order Code	List Price (RM)
16	A1B 125	50%	TMF	1SDA068747R1	313.00	1SDA068751R1	416.00
20	A1B 125	50%	TMF	1SDA066698R1	313.00	1SDA066734R1	416.00
25	A1B 125	50%	TMF	1SDA066699R1	313.00	1SDA066735R1	416.00
32	A1B 125	50%	TMF	1SDA068758R1	313.00	1SDA068762R1	416.00
40	A1B 125	50%	TMF	1SDA066701R1	313.00	1SDA066737R1	416.00
50	A1B 125	50%	TMF	1SDA066702R1	313.00	1SDA066738R1	416.00
63	A1B 125	50%	TMF	1SDA068769R1	313.00	1SDA068773R1	416.00
80	A1B 125	50%	TMF	1SDA066705R1	313.00	1SDA066741R1	416.00
100	A1B 125	50%	TMF	1SDA066707R1	313.00	1SDA066743R1	416.00
125	A2B 250	50%	TMF	1SDA066548R1	443.00	1SDA066554R1	597.00
160	A2B 250	50%	TMF	1SDA066549R1	443.00	1SDA066555R1	597.00
200	A2B 250	50%	TMF	1SDA066551R1	559.00	1SDA066557R1	765.00
250	A2B 250	50%	TMF	1SDA066553R1	621.00	1SDA066559R1	827.00

TMF = Fixed Thermal & Magnetic Threshold

* Compulsory add-on terminals for ratings from 160A to 250A
Please refer to the connection terminals on page 38

*NOTE: All List Prices Excluding 6% GST

Moulded Case Circuit Breakers (MCCB)

Formula Series – A1C, A2C
25kA Icu @ 415VAC



In	Model	Ics (% of Icu)	Trip Unit	3 Poles		4 Poles	
				Order Code	List Price (RM)	Order Code	List Price (RM)
16A	A1C 125	25%	TMF	1SDA068748R1	354.00	1SDA068752R1	457.00
20A	A1C 125	25%	TMF	1SDA066710R1	354.00	1SDA066746R1	457.00
25A	A1C 125	25%	TMF	1SDA066711R1	354.00	1SDA066747R1	457.00
32A	A1C 125	25%	TMF	1SDA068759R1	354.00	1SDA068763R1	457.00
40A	A1C 125	25%	TMF	1SDA066713R1	354.00	1SDA066749R1	457.00
50A	A1C 125	25%	TMF	1SDA066714R1	354.00	1SDA066750R1	457.00
63A	A1C 125	25%	TMF	1SDA068770R1	354.00	1SDA068774R1	457.00
80A	A1C 125	25%	TMF	1SDA066717R1	354.00	1SDA066753R1	457.00
100A	A1C 125	25%	TMF	1SDA066719R1	354.00	1SDA066755R1	457.00
125A	A2C 250	50%	TMF	1SDA066775R1	613.00	1SDA066787R1	767.00
160A	A2C 250	50%	TMF	1SDA066776R1	613.00	1SDA066788R1	767.00
200A	A2C 250	50%	TMF	1SDA066778R1	847.00	1SDA066790R1	1,053.00
250A	A2C 250	50%	TMF	1SDA066780R1	970.00	1SDA066792R1	1,176.00

TMF = Fixed Thermal & Magnetic Threshold

* **Compulsory add-on terminals for ratings from 160A to 250A**
Please refer to the connection terminals on page 38

Moulded Case Circuit Breakers (MCCB)

Formula Series – A1N, A2N, A3N

36kA Icu @ 415VAC



2

In	Model	Ics (% of Icu)	Trip Unit	3 Poles		4 Poles	
				Order Code	List Price (RM)	Order Code	List Price (RM)
16A	A1N 125	25%	TMF	1SDA068749R1	395.00	1SDA068753R1	498.00
20A	A1N 125	25%	TMF	1SDA066722R1	395.00	1SDA066758R1	498.00
25A	A1N 125	25%	TMF	1SDA066723R1	395.00	1SDA066759R1	498.00
32A	A1N 125	25%	TMF	1SDA068760R1	395.00	1SDA068764R1	498.00
40A	A1N 125	25%	TMF	1SDA066725R1	395.00	1SDA066761R1	498.00
50A	A1N 125	25%	TMF	1SDA066726R1	395.00	1SDA066762R1	498.00
63A	A1N 125	25%	TMF	1SDA068771R1	395.00	1SDA068775R1	498.00
80A	A1N 125	25%	TMF	1SDA066729R1	395.00	1SDA066765R1	498.00
100A	A1N 125	25%	TMF	1SDA066731R1	395.00	1SDA066767R1	498.00
125A	A2N 250	50%	TMF	1SDA066781R1	669.00	1SDA066793R1	824.00
160A	A2N 250	50%	TMF	1SDA066782R1	669.00	1SDA066794R1	824.00
200A	A2N 250	50%	TMF	1SDA066784R1	976.00	1SDA066796R1	1,182.00
250A	A2N 250	50%	TMF	1SDA066786R1	1,010.00	1SDA066798R1	1,216.00
320A	A3N 400	50%	TMF	1SDA066560R1	1,739.00	1SDA066568R1	2,048.00
400A	A3N 400	50%	TMF	1SDA066561R1	1,739.00	1SDA066569R1	2,048.00
500A	A3N 630	50%	TMF	1SDA066564R1	2,005.00	1SDA066572R1	2,314.00
630A	A3N 630	50%	ELT. LI	1SDA066566R1	2,507.00	1SDA066574R1	2,816.00

TMF = Fixed Thermal & Magnetic Threshold
 ELT. LI = Fixed Electronic Tripping Unit. L and I Protection

* **Compulsory add-on terminals for ratings from 160A to 630A**
 Please refer to the connection terminals on page 38



Formula Series – A3S

50kA Icu @ 415VAC







In	Model	Ics (% of Icu)	Trip Unit	3 Poles		4 Poles	
				Order Code	List Price (RM)	Order Code	List Price (RM)
320	A3S 400	50%	TMF	1SDA066562R1	1,905.00	1SDA066570R1	2,214.00
400	A3S 400	50%	TMF	1SDA066563R1	1,905.00	1SDA066571R1	2,214.00
500	A3S 630	50%	TMF	1SDA066565R1	2,634.00	1SDA066573R1	2,943.00
630	A3S 630	50%	ELT. LI	1SDA066567R1	2,941.00	1SDA066575R1	3,250.00

TMF = Fixed Thermal & Magnetic Threshold
 ELT. LI = Fixed Electronic Tripping Unit. L and I Protection

* **Compulsory add-on terminals for ratings from 160A to 630A**
 Please refer to the connection terminals on page 38

Moulded Case Circuit Breakers (MCCB)

Accessories for Formula MCCB A1 – A2 – A3

Type	Description	Order Code	List Price (RM)	
	Shunt Opening Release – SOR			
	For A1 – A2 (Cabled) For A3 (Cabled)	220...240 V AC – 220...250 V DC 220...240 V AC – 220...250 V DC	1SDA066137R1 1SDA054873R1	142.00 346.00
	Undervoltage Release – UVR			
	For A1 – A2 (Cabled) For A3 (Cabled)	380...440 V AC 380...440 V AC	1SDA066147R1 1SDA054892R1	254.00 473.00
	Auxiliary Contacts – AUX			
	For A1 & A2 – 2 Poles (Cabled)	1Q + 1SY 250 V AC/DC 2Q + 1SY 250 V AC/DC	1SDA066151R1 1SDA066152R1	184.00 227.00
	For A1 & A2 – 3 & 4 poles (Cabled)	1Q + 1SY 250 V AC/DC 2Q + 1SY 250 V AC/DC	1SDA066149R1 1SDA066150R1	318.00 336.00
	For A3 – 3 & 4 poles (Cabled)	1Q + 1SY 250 V AC/DC 3Q + 1SY 250 V AC/DC	1SDA054910R1 1SDA054911R1	365.00 618.00
	Q : open/close signalling contact SY : trip signalling contact			
	Rotary Handle – Direct Type RHD			
	For A1 – A2 For A3		1SDA066154R1 1SDA066155R1	128.00 149.00
	Rotary Handle – Transmitted Type RHE			
	For A1 – A2 For A3		1SDA066158R1 1SDA066159R1	149.00 216.00
	Connection Terminal			
	Kit EF A1 – 3 poles Kit EF A1 – 4 poles	Extended Front Extended Front	1SDA066216R1 1SDA066217R1	70.00 94.00
	Kit EF A2 – 3 poles Kit EF A2 – 4 poles	Extended Front Extended Front	1SDA066222R1 1SDA066223R1	77.00 103.00
	Kit EF A3 – 3 poles Kit EF A3 – 4 poles	Extended Front Extended Front	1SDA055034R1 1SDA055035R1	266.00 353.00

Moulded Case Circuit Breakers (MCCB)

Tmax Series - XT1B

18kA Icu @ 415VAC

Ics = 100% Icu



2

In	Model	Trip Unit	3 Poles		4 Poles	
			Order Code	List Price (RM)	Order Code	List Price (RM)
16A	XT1B 160	TMD	1SDA066799R1	449.00	1SDA066810R1	695.00
20A	XT1B 160	TMD	1SDA066800R1	449.00	1SDA066811R1	695.00
25A	XT1B 160	TMD	1SDA066801R1	449.00	1SDA066812R1	695.00
32A	XT1B 160	TMD	1SDA066802R1	449.00	1SDA066813R1	695.00
40A	XT1B 160	TMD	1SDA066803R1	449.00	1SDA066814R1	695.00
50A	XT1B 160	TMD	1SDA066804R1	449.00	1SDA066815R1	695.00
63A	XT1B 160	TMD	1SDA066805R1	449.00	1SDA066816R1	695.00
80A	XT1B 160	TMD	1SDA066806R1	449.00	1SDA066817R1	695.00
100A	XT1B 160	TMD	1SDA066807R1	449.00	1SDA066818R1	695.00
125A	XT1B 160	TMD	1SDA066808R1	495.00	1SDA066888R1	751.00
160A	XT1B 160	TMD	1SDA066809R1	778.00	1SDA066821R1	1011.00

TMD = Adjustable Thermal and Fixed Magnetic Protection Threshold

Tmax Series - XT1C

25kA Icu @ 415VAC

Ics = 100% Icu



In	Model	Trip Unit	3 Poles		4 Poles	
			Order Code	List Price (RM)	Order Code	List Price (RM)
25A	XT1C 160	TMD	1SDA067391R1	534.00	1SDA067400R1	880.00
32A	XT1C 160	TMD	1SDA067392R1	534.00	1SDA067401R1	880.00
40A	XT1C 160	TMD	1SDA067393R1	534.00	1SDA067402R1	880.00
50A	XT1C 160	TMD	1SDA067394R1	534.00	1SDA067403R1	880.00
63A	XT1C 160	TMD	1SDA067395R1	534.00	1SDA067404R1	880.00
80A	XT1C 160	TMD	1SDA067396R1	534.00	1SDA067405R1	880.00
100A	XT1C 160	TMD	1SDA067397R1	534.00	1SDA067406R1	880.00
125A	XT1C 160	TMD	1SDA067398R1	686.00	1SDA067409R1	918.00
160A	XT1C 160	TMD	1SDA067399R1	1001.00	1SDA067410R1	1302.00

TMD = Adjustable Thermal and Fixed Magnetic Protection Threshold

Compulsory add-on terminals for rating 160A

Description	Terminal	3 Poles		4 Poles	
		Order Code	List Price (RM)	Order Code	List Price (RM)
KIT EF XT1	Extended Front	1SDA066867R1	164.00	1SDA066868R1	213.00

Example: When ordering MCCB, XT1C 160 1SDA067399R1
Please add accessory KIT EF XT1 1SDA066867R1

*NOTE: All List Prices Excluding 6% GST

Moulded Case Circuit Breakers (MCCB)

Tmax Series - XT2N, XT4N, T4N, T5N, T6N

36kA Icu @ 415VAC

Ics = 100% Icu



In	Model	Trip Unit	Order Code		List Price (RM)	
			3 Poles		4 Poles	
16A	XT2N 160	TMD	1SDA067010R1	763.00	1SDA067031R1	1,244.00
20A	XT2N 160	TMD	1SDA067011R1	763.00	1SDA067032R1	1,244.00
25A	XT2N 160	TMD	1SDA067012R1	763.00	1SDA067033R1	1,244.00
32A	XT2N 160	TMD	1SDA067013R1	763.00	1SDA067034R1	1,244.00
40A	XT2N 160	TMA	1SDA067014R1	763.00	1SDA067035R1	1,244.00
50A	XT2N 160	TMA	1SDA067015R1	763.00	1SDA067036R1	1,244.00
63A	XT2N 160	TMA	1SDA067016R1	763.00	1SDA067037R1	1,244.00
80A	XT2N 160	TMA	1SDA067017R1	763.00	1SDA067038R1	1,244.00
100A	XT2N 160	TMA	1SDA067018R1	763.00	1SDA067039R1	1,244.00
125A	XT2N 160	TMA	1SDA067019R1	868.00	1SDA067042R1	1,301.00
160A	XT2N 160	TMA	1SDA067020R1	1,099.00	1SDA067043R1	1,667.00
200A	XT4N 250	TMA	1SDA068090R1	1,394.00	1SDA068109R1	2,031.00
250A	XT4N 250	TMA	1SDA068092R1	1,394.00	1SDA068111R1	2,031.00
320A	T4N 320	PR221DS-LS/I	1SDA054117R1	2,212.00	1SDA054121R1	3,846.00
400A	T5N 400	PR221DS-LS/I	1SDA054317R1	2,424.00	1SDA054325R1	4,612.00
500A	T5N 630	TMA	1SDA054456R1	3,461.00	1SDA054487R1	5,767.00
630A	T5N 630	PR221DS-LS/I	1SDA054396R1	3,807.00	1SDA054400R1	6,150.00
800A	T6N 800	PR221DS-LS/I	1SDA060268R1	4,806.00	1SDA060273R1	7,689.00

TMD = Adjustable Thermal and Fixed Magnetic Protection Threshold

TMA = Adjustable Thermal and Magnetic Protection Threshold

PR221DS-LS/I = Electronic Tripping Unit. L and, S or I Protection



Compulsory add-on terminals for ratings from 160A to 1600A

Description	Terminal	Order Code		List Price (RM)	
		3 Poles		4 Poles	
KIT EF XT2	Extended Front	1SDA066871R1	130.00	1SDA066872R1	174.00
KIT ES XT4	Extended Spread	1SDA066903R1	211.00	1SDA066904R1	288.00
KIT ES T4	Extended Spread	1SDA055002R1	211.00	1SDA055003R1	288.00
KIT ES T5	Extended Spread	1SDA055038R1	356.00	1SDA055039R1	468.00
KIT EF T6 (800A)	Extended Front	1SDA013954R1	748.00	1SDA013955R1	971.00

Example: When ordering MCCB, T4N 320 1SDA054117R1
Please add accessory KIT ES T4 1SDA055002R1

Moulded Case Circuit Breakers (MCCB)

Tmax Series - XT2S, XT4S, T4S, T5S, T6S, T7S

50kA Icu @ 415VAC

Ics = 100% Icu



2

In	Model	Trip Unit	Order Code List Price (RM)		Order Code List Price (RM)	
			3 Poles		4 Poles	
16A	XT2S 160	TMD	1SDA0 67550 R1	859.00	1SDA0 67571 R1	1,321.00
20A	XT2S 160	TMD	1SDA0 67551 R1	859.00	1SDA0 67572 R1	1,321.00
25A	XT2S 160	TMD	1SDA0 67552 R1	859.00	1SDA0 67573 R1	1,321.00
32A	XT2S 160	TMD	1SDA0 67553 R1	859.00	1SDA0 67574 R1	1,321.00
40A	XT2S 160	TMA	1SDA0 67554 R1	859.00	1SDA0 67575 R1	1,321.00
50A	XT2S 160	TMA	1SDA0 67555 R1	859.00	1SDA0 67576 R1	1,321.00
63A	XT2S 160	TMA	1SDA0 67556 R1	859.00	1SDA0 67577 R1	1,321.00
80A	XT2S 160	TMA	1SDA0 67557 R1	859.00	1SDA0 67578 R1	1,321.00
100A	XT2S 160	TMA	1SDA0 67558 R1	859.00	1SDA0 67579 R1	1,321.00
125A	XT2S 160	TMA	1SDA0 67559 R1	963.00	1SDA0 67582 R1	1,540.00
160A	XT2S 160	TMA	1SDA0 67560 R1	1,140.00	1SDA0 67583 R1	1,771.00
200A	XT4S 250	TMA	1SDA0 68310 R1	1,565.00	1SDA0 68329 R1	2,241.00
250A	XT4S 250	TMA	1SDA0 68312 R1	1,565.00	1SDA0 68331 R1	2,241.00
320A	T4S 320	PR221DS-LS/I	1SDA0 54125 R1	2,384.00	1SDA0 54129 R1	4,806.00
400A	T5S 400	PR221DS-LS/I	1SDA0 54333 R1	2,636.00	1SDA0 54341 R1	4,999.00
500A	T5S 630	TMA	1SDA0 54461 R1	3,846.00	1SDA0 54489 R1	6,920.00
630A	T5S 630	PR221DS-LS/I	1SDA054404R1	4,230.00	1SDA054408R1	7,304.00
800A	T6S 800	PR221DS-LS/I	1SDA060278R1	5,305.00	1SDA060283R1	8,457.00
1000A	T6S 1000	PR221DS-LS/I	1SDA076855R1	8,955.00	1SDA076877R1	12,990.00
1250A	T7S 1250	PR231/P-LS/I	1SDA062866R1	11,224.00	1SDA062874R1	14,604.00
1600A	T7S 1600	PR231/P-LS/I	1SDA062994R1	14,682.00	1SDA063002R1	22,674.00

TMD = Adjustable Thermal and Fixed Magnetic Protection Threshold

TMA = Adjustable Thermal and Magnetic Protection Threshold

PR221DS-LS/I = Electronic Tripping Unit. L and, S or I Protection

PR231/P-LS/I = Electronic Tripping Unit. L and, S or I Protection



Compulsory add-on terminals for ratings from 160A to 1600A*

*KIT EF T6 already included in T6S 1000 MCCB

Description	Terminal	Order Code List Price (RM)		Order Code List Price (RM)	
		3 Poles		4 Poles	
KIT EF XT2	Extended Front	1SDA066871R1	130.00	1SDA066872R1	174.00
KIT ES XT4	Extended Spread	1SDA066903R1	211.00	1SDA066904R1	288.00
KIT ES T4	Extended Spread	1SDA055002R1	211.00	1SDA055003R1	288.00
KIT ES T5	Extended Spread	1SDA055038R1	356.00	1SDA055039R1	468.00
KIT EF T6 (800A)	Extended Front	1SDA013954R1	748.00	1SDA013955R1	971.00
KIT EF T6 (1000A)	Extended Front	1SDA064321R1	Included	1SDA064322R1	Included
KIT EF T7	Extended Front	1SDA063105R1	1,233.00	1SDA063106R1	1,607.00

Example: When ordering MCCB, T4S 320 1SDA054125R1
Please add accessory KIT ES T4 1SDA055002R1

Moulded Case Circuit Breakers (MCCB)

Tmax Series - XT2H, XT4H, T4H, T5H, T6H, T7H

70kA Icu @ 415VAC

Ics = 100% Icu



In	Model	Trip Unit	3 Poles		4 Poles	
			Order Code	List Price (RM)	Order Code	List Price (RM)
16A	XT2H 160	TMD	1SDA067594R1	994.00	1SDA067615R1	1,492.00
20A	XT2H 160	TMD	1SDA067595R1	994.00	1SDA067616R1	1,492.00
25A	XT2H 160	TMD	1SDA067596R1	994.00	1SDA067617R1	1,492.00
32A	XT2H 160	TMD	1SDA067597R1	994.00	1SDA067618R1	1,492.00
40A	XT2H 160	TMA	1SDA067598R1	994.00	1SDA067619R1	1,492.00
50A	XT2H 160	TMA	1SDA067599R1	994.00	1SDA067620R1	1,492.00
63A	XT2H 160	TMA	1SDA067600R1	994.00	1SDA067621R1	1,492.00
80A	XT2H 160	TMA	1SDA067601R1	994.00	1SDA067622R1	1,492.00
100A	XT2H 160	TMA	1SDA067602R1	994.00	1SDA067623R1	1,492.00
125A	XT2H 160	TMA	1SDA067603R1	994.00	1SDA067626R1	1,724.00
160A	XT2H 160	TMA	1SDA067604R1	1,156.00	1SDA067627R1	2,077.00
200A	XT4H 250	TMA	1SDA068343R1	1,617.00	1SDA068362R1	2,808.00
250A	XT4H 250	TMA	1SDA068345R1	1,617.00	1SDA068364R1	2,808.00
320A	T4H 320	PR221DS-LS/I	1SDA054133R1	2,577.00	1SDA054137R1	4,806.00
400A	T5H 400	PR221DS-LS/I	1SDA054349R1	2,827.00	1SDA054357R1	5,722.00
500A	T5H 630	TMA	1SDA054465R1	4,536.00	1SDA054491R1	8,072.00
630A	T5H 630	PR221DS-LS/I	1SDA054412R1	4,806.00	1SDA054416R1	8,457.00
800A	T6H 800	PR221DS-LS/I	1SDA060289R1	7,688.00	1SDA060294R1	10,300.00
1000A	T6H 1000	PR221DS-LS/I	1SDA076864R1	10,186.00	1SDA060566R1	14,604.00
1250A	T7H 1250	PR231/P-LS/I	1SDA062898R1	12,684.00	1SDA062906R1	16,718.00
1600A	T7H 1600	PR231/P-LS/I	1SDA063026R1	16,066.00	1SDA063034R1	24,978.00

TMD = Adjustable Thermal and Fixed Magnetic Protection Threshold

TMA = Adjustable Thermal and Magnetic Protection Threshold

PR221DS-LS/I = Electronic Tripping Unit. L and, S or I Protection

PR231/P-LS/I = Electronic Tripping Unit. L and, S or I Protection



Compulsory add-on terminals for ratings from 160A to 1600A*

*KIT EF T6 already included for T6H 1000 MCCB

Description	Terminal	3 Poles		4 Poles	
		Order Code	List Price (RM)	Order Code	List Price (RM)
KIT EF XT2	Extended Front	1SDA0 66871 R1	130.00	1SDA0 66872 R1	174.00
KIT ES XT4	Extended Spread	1SDA0 66903 R1	211.00	1SDA0 66904 R1	288.00
KIT ES T4	Extended Spread	1SDA0 55002 R1	211.00	1SDA0 55003 R1	288.00
KIT ES T5	Extended Spread	1SDA0 55038 R1	356.00	1SDA0 55039 R1	468.00
KIT EF T6 (800A)	Extended Front	1SDA0 13954 R1	748.00	1SDA0 13955 R1	971.00
KIT EF T6 (1000A)	Extended Front	1SDA0 64321 R1	Included	1SDA0 64322 R1	Included
KIT EF T7	Extended Front	1SDA0 63105 R1	1,233.00	1SDA0 63106 R1	1,607.00

Example: When ordering MCCB, T4H 320 1SDA054133R1
Please add accessory KIT ES T4 1SDA055002R1

Moulded Case Circuit Breakers (MCCB) Accessories

Accessories for Tmax MCCB XT1, XT2, XT4

Type	Description	Order Code	List Price (RM)	
	220...240 V AC – 220...250 V DC	1SDA066325R1	248.00	
	380...440 V AC	1SDA066326R1	248.00	
	220...240 V AC – 220...250 V DC	1SDA066399R1	401.00	
	380...440 V AC	1SDA066400R1	401.00	
<p>Q : open/close signalling contact SY : trip signalling contact</p>	1Q + 1SY 250V AC / DC	1SDA066431R1	274.00	
	2Q + 1SY 250V AC / DC	1SDA066433R1	365.00	
	For XT1	For fixed / plug-in	1SDA066475R1	227.00
	For XT2 & XT4	For fixed / plug-in	1SDA069053R1	227.00
	For XT1	For fixed / plug-in	1SDA066479R1	274.00
	For XT2 & XT4	For fixed / plug-in	1SDA069055R1	274.00
	Motor Operator with direct action - MOD	220...250V AC / DC	1SDA066460R1	2,349.00
	Stored energy Motor Operator – MOE	220...250V AC / DC	1SDA066466R1	2,349.00
	PLL Removable lock with padlocks	in open position	1SDA066588R1	219.00
	PLL Fixed lock with padlocks	in open / closed position	1SDA066591R1	255.00
	PLL Fixed lock with padlocks	in open / closed position	1SDA066592R1	255.00

*NOTE: All List Prices Excluding 6% GST

Moulded Case Circuit Breakers (MCCB) Accessories

Accessories for Tmax MCCB XT1, XT2, XT4

Type	Description	Order Code	List Price (RM)
Key Lock on the Circuit-Breaker			
XT1 - KLC Ronis key lock open, different keys	removable in open position	1SDA066593R1	401.00
XT1 - KLC Ronis key lock open, same Type A keys	removable in open position	1SDA066594R1	401.00
XT2 & XT4 - KLC Ronis key lock open, different keys	removable in open position	1SDA066599R1	401.00
XT2 & XT4 - KLC Ronis key lock open, same Type A keys	removable in open position	1SDA066600R1	401.00
Key Lock on the Handle			
XT1, XT2 & XT4 - RHL Ronis key lock open, different keys		1SDA066617R1	401.00
XT1, XT2 & XT4 - RHL Ronis key lock open, same Type A keys		1SDA066618R1	401.00
Key Lock on the Motor			
XT1 - MOL-D Ronis key lock open, different keys		1SDA066623R1	401.00
XT1 - MOL-S Ronis key lock open, same Type A keys		1SDA066624R1	401.00
XT2 & XT4 - MOL-D Ronis key lock open, different keys		1SDA066629R1	401.00
XT2 & XT4 - MOL-S Ronis key lock open, same Type A keys		1SDA066630R1	401.00
Mechanical Interlock			
MIR-H	horizontal chassis	1SDA066637R1	876.00
MIR-V	vertical chassis	1SDA066638R1	876.00
Plate XT1 (fixed type)	plate for XT1	1SDA066639R1	361.00
Plate XT2 (fixed type)	plate for XT2	1SDA066641R1	361.00
Plate XT4 (fixed type)	plate for XT4	1SDA066645R1	361.00
The acceptable combinations are:			
<ul style="list-style-type: none"> • XT1-XT1 • XT2-XT4 • XT1-XT2 • XT2-XT2 • XT1-XT3 • XT3-XT3 • XT1-XT4 • XT4-XT4 			
The following equipment must be ordered to make the rear interlock:			
<ul style="list-style-type: none"> • a vertical or horizontal chassis; • a plate for each circuit-breaker to be interlocked 			
			
Residual Current Releases			
For XT1	RC Sel – 3 poles	1SDA067123R1	1,904.00
	RC Sel – 4 poles	1SDA067125R1	2,285.00
For XT2	RC Sel – 4 poles	1SDA067126R1	3,111.00
For XT4	RC Sel – 4 poles	1SDA067131R1	5,981.00
Automatic Transfer Devices			
ATS021		1SDA065523R1	8,594.00
ATS022		1SDA065524R1	19,203.00

Moulded Case Circuit Breakers (MCCB) Accessories

Accessories for Tmax MCCB XT1, XT2, XT4 (Fixed Parts, conversion kit and accessories for fixed parts)

Type	Description	Order Code	List Price (RM)
Fixed Part of Plug-in (P) – XT1	KIT P PF EF – 3 poles	1SDA068183R1	581.00
	KIT P PF EF – 4 poles	1SDA068185R1	780.00
Conversion kit of the circuit-breaker from fixed into moving part of plug-in – XT1	P MP KIT – 3 poles	1SDA066276R1	272.00
	P MP KIT – 4 poles	1SDA066277R1	365.00
Fixed Part of Plug-in (P) – XT2	KIT P PF EF – 3 poles	1SDA068187R1	617.00
	KIT P PF EF – 4 poles	1SDA068190R1	802.00
Conversion kit of the circuit-breaker from fixed into moving part of plug-in – XT2	P MP KIT – 3 poles	1SDA066278R1	305.00
	P MP KIT – 4 poles	1SDA066279R1	324.00
Fixed Part of Plug-in (P) – XT4	KIT P PF EF – 3 poles	1SDA068196R1	849.00
	KIT P PF EF – 4 poles	1SDA068198R1	1,103.00
Conversion kit of the circuit-breaker from fixed into moving part of plug-in – XT4	P MP KIT – 3 poles	1SDA066282R1	426.00
	P MP KIT – 4 poles	1SDA066283R1	454.00

Ordering Example



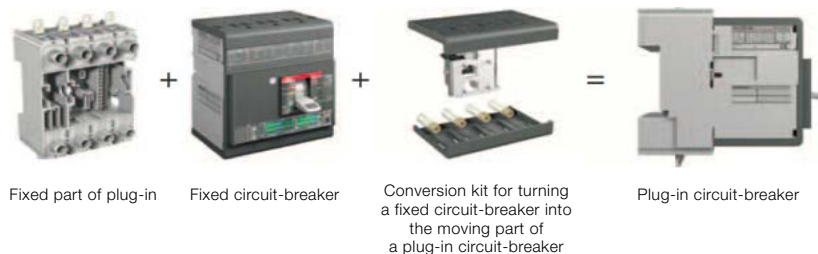



The following equipment must be ordered to make the converting the fixed circuit-breaker into the moving part of plug-in version.



Example:	When ordering Plug-in (P) MCCB,	XT1B	1SDA066808R1
	Please add accessories	i) KIT P PF EF	1SDA068183R1
		ii) P MP KIT	1SDA066276R1



Moulded Case Circuit Breakers (MCCB) Accessories

Accessories for Tmax MCCB T4 – T5 – T6

Type	Description	Order Code	List Price (RM)
 <p>Shunt Opening Release – SOR-C (Cabled Version)</p>	220...240 V AC – 220...250 V DC	1SDA054873R1	346.00
	380...440 V AC	1SDA054874R1	346.00
 <p>Undervoltage Release – UVR-C (Cabled Version)</p>	220...240 V AC – 220...250 V DC	1SDA054891R1	473.00
	380...440 V AC	1SDA054892R1	473.00
 <p>Auxiliary Contacts – AUX-C (Cabled Version)</p> <p>Q : open/close signalling contact SY : trip signalling contact</p>	1Q + 1SY 250V AC / DC	1SDA054910R1	365.00
	3Q + 1SY 250V AC / DC	1SDA054911R1	618.00
 <p>Rotary Handle – Direct Type RHD</p> <p>For T4 – T5 For T6</p>	For fixed / plug-in	1SDA054926R1	382.00
	For fixed / plug-in	1SDA060405R1	563.00
 <p>Rotary Handle – Direct Type RHE</p> <p>For T4 – T5 For T6</p>	For fixed / plug-in	1SDA054929R1	494.00
	For fixed / plug-in	1SDA060409R1	762.00
 <p>Stored energy Motor Operator - MOE</p> <p>For T4 – T5 For T6</p>	220...250V AC / DC	1SDA054897R1	5,362.00
	220...250V AC / DC	1SDA060398R1	7,609.00
 <p>Front Lever Operating Mechanism - FLD</p> <p>For T4 – T5 For T6</p>	For fixed / plug-in	1SDA054944R1	425.00
	For fixed / plug-in	1SDA060417R1	552.00









Moulded Case Circuit Breakers (MCCB) Accessories

Accessories for Tmax MCCB T4 – T5 – T6

Type	Description	Order Code	List Price (RM)	
	Key-Lock For Front/Rotary handle - KLF			
	For T4 – T5	KLF-D – Different Key	1SDA054939R1	418.00
		KLF-S – Same Key (N.20005)	1SDA054940R1	418.00
	For T6	KLF-D – Different Key	1SDA060658R1	480.00
	KLF-S – Same Key (N.20005)	1SDA060659R1	480.00	
	Key-Lock For motor operator- MOL			
	For T4 – T5	MOL-D – Different Key	1SDA054904R1	418.00
		MOL-S – Same Key (N.20005)	1SDA054905R1	418.00
	For T6	MOL-D – Different Key	1SDA060611R1	480.00
	MOL-S – Same Key (N.20005)	1SDA060612R1	480.00	
Mechanical Interlock – T4 – T5				
MIR-HB frame unit	horizontal chassis	1SDA054946R1	876.00	
MIR-VB frame unit	vertical chassis	1SDA054947R1	876.00	
	Plate for interlock	Type A	1SDA054948R1	361.00
		Type B	1SDA054949R1	361.00
		Type C	1SDA054950R1	361.00
		Type D	1SDA054951R1	361.00
		Type E	1SDA054952R1	361.00
		Type F	1SDA054953R1	361.00
Note: To interlock two circuit-breakers you have to order a frame unit interlock and a plate (for type A or B or C or D or E or F) Interlock				
Type				
A	T4 (F-P-W)	+	T4 (F-P-W)	
B	T4 (F-P-W)	+	T5 400 (F-P-W) o T5 630 (F)	
C	T4 (F-P-W)	+	T5 630 (P-W)	
D	T5 400 (F-P-W) o T5 630 (F)	+	T5 400 (F-P-W) o T5 630 (F)	
E	T5 400 (F-P-W) o T5 630 (F)	+	T5 630 (P-W)	
F	T5 630 (P-W)	+	T5 630 (P-W)	
Mechanical Interlock – T6				
Horizontal interlock		1SDA060685R1	3,443.00	
Vertical interlock		1SDA060686R1	3,443.00	
Residual Current Releases				
	For T4 – 4 poles	RC222 / 4	1SDA054954R1	6,160.00
	For T5 – 4 poles	RC222 / 5	1SDA054955R1	9,058.00
Automatic Transfer Devices				
	ATS021		1SDA065523R1	8,594.00
	ATS022		1SDA065524R1	19,203.00



Moulded Case Circuit Breakers (MCCB) Accessories

Accessories for Tmax MCCB T7 – T7M

Type	Description	Order Code	List Price (RM)
 Shunt Opening Release – SOR (Uncabled Version)	220...240 V AC / DC	1SDA063548R1	782.00
	380...400 V AC / DC	1SDA062071R1	782.00
	415...440 V AC / DC	1SDA062072R1	782.00
 Shunt Closing Release – SCR (Cabled Version, Only for T7M)	220...240 V AC / DC	1SDA063550R1	782.00
	380...400 V AC / DC	1SDA062082R1	782.00
	415...440 V AC / DC	1SDA062083R1	782.00
 Undervoltage Release – UVR (Uncabled Version)	240...250 V AC / DC	1SDA063552R1	654.00
	380...400 V AC / DC	1SDA062093R1	654.00
	415...440 V AC / DC	1SDA062094R1	654.00
 Auxiliary Contact For T7 (Uncabled) For T7M (Uncabled) Q : open/close signalling contact SY : trip signalling contact	AUX-C 1Q 1SY 400 V AC	1SDA062104R1	726.00
	AUX-C 2Q 400 V AC	1SDA062102R1	726.00
	AUX-C 2Q 400 V AC	1SDA062102R1	726.00
 Rotary Handle – Direct Type RHD		1SDA062120R1	799.00
 Rotary Handle – Direct Type RHE		1SDA062122R1	907.00
 Key-Lock in Open Position on the Circuit-Breaker - KLC For T7 For T7M	KLC-D – Different Key	1SDA062134R1	401.00
	KLC-S – Same Key (N.20005)	1SDA062135R1	401.00
	KLC-D – Different Key	1SDA062141R1	401.00
	KLC-S – Same Key (N.20005)	1SDA062142R1	401.00
 Padlock Lever Lock - PLL For T7 For T7M	Padlock in Open Position	1SDA062150R1	292.00
	Padlock in Open Position	1SDA062151R1	292.00
 Key-Lock For Front/Rotary handle - KLF For T7	KLF-D – Different Key	1SDA063555R1	509.00
	KLF-S – Same Key (N.20005)	1SDA063556R1	509.00

Moulded Case Circuit Breakers (MCCB) Accessories

Accessories for Tmax MCCB T7 – T7M

Type	Description	Order Code	List Price (RM)
 Mechanical Operation Counter		1SDA062160R1	365.00
 Automatic transfer devices	ATS021	1SDA065523R1	8,594.00
	ATS022	1SDA065524R1	19,203.00



Motorizable T7M

In	Model	Trip Unit	Order Code		List Price (RM)	
			3 Poles	4 Poles	3 Poles	4 Poles
50kA Icu @ 415VAC						
1250A	T7S 1250M	ELT. LS/I	1SDA062882R1	11,955.00	1SDA062890R1	17,026.00
1600A	T7S 1600M	ELT. LS/I	1SDA063010R1	15,758.00	1SDA063018R1	25,355.00
70kA Icu @ 415VAC						
1250A	T 7H 1250M	ELT. LS/I	1SDA062914R1	13,403.00	1SDA062922R1	19,923.00
1600A	T7H 1600M	ELT. LS/I	1SDA063042R1	17,387.00	1SDA063050R1	30,066.00

ELT. LS/I = Electronic Tripping Unit. L and, S or I Protection



Compulsory accessories for Motorized T7M

Description	Terminal	Order Code		List Price (RM)	
		3 Poles	4 Poles	3 Poles	4 Poles
SOR	220...240 V AC / DC	1SDA063548R1	782.00	1SDA063548R1	782.00
SCR	220...240 V AC / DC	1SDA063550R1	782.00	1SDA063550R1	782.00
Spring Charging Motor	220...240 V AC / DC	1SDA062116R1	7,609.00	1SDA062116R1	7,609.00
KIT EF T7	Extended Front	1SDA063105R1	1,233.00	1SDA063106R1	1,607.00

Example: When ordering MCCB, Please add accessories

- T7H 1600M 1SDA063042R1
- i) SOR 1SDA063548R1
- ii) SCR 1SDA063550R1
- iii) KIT EF T7 1SDA063105R1
- iv) Including motor spring charging motor 1SDA062116R1

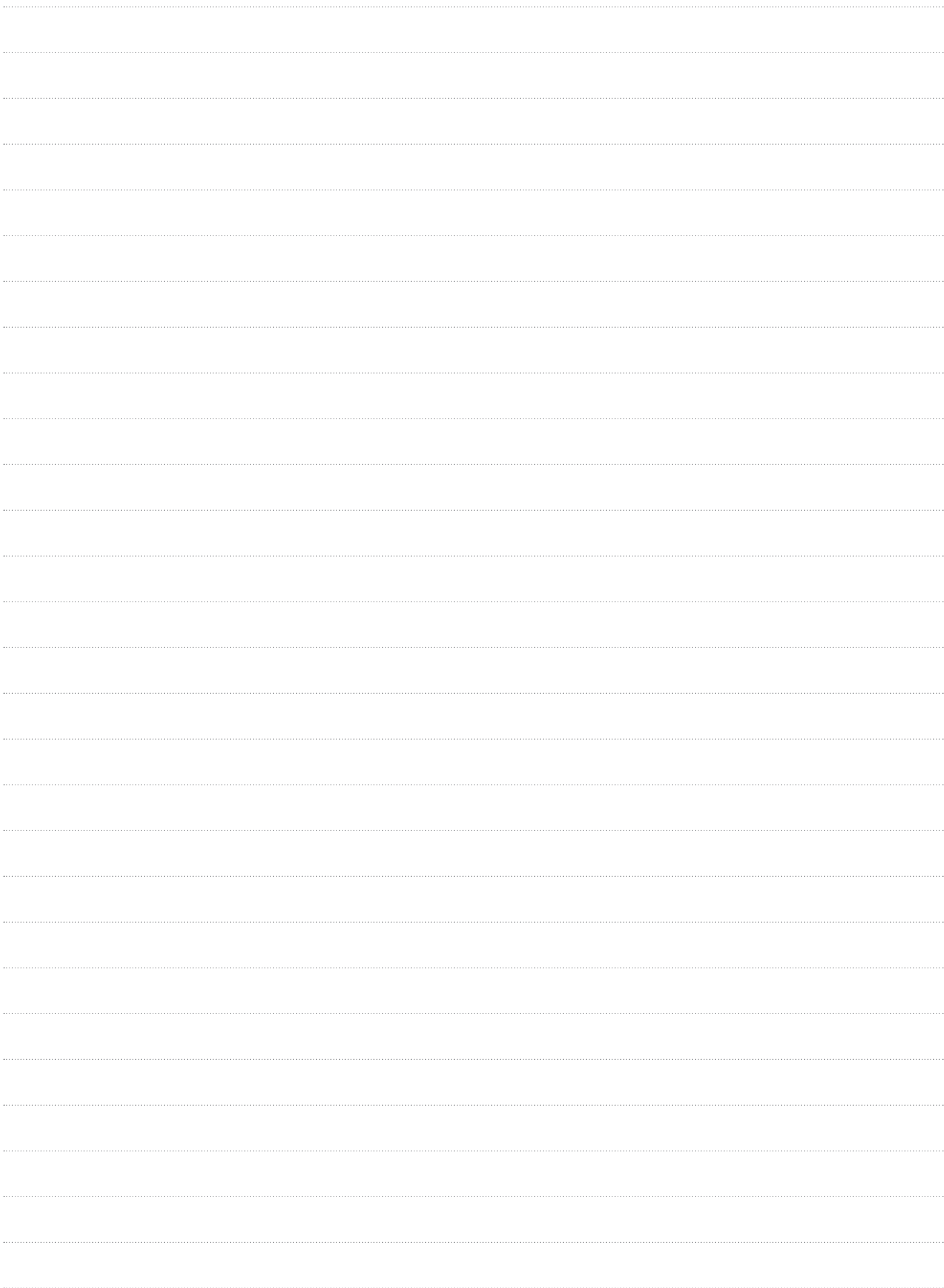

Air Circuit Breakers (ACB)



Overview of the SACE Emax2 Family

Over 15% average footprint reduction!

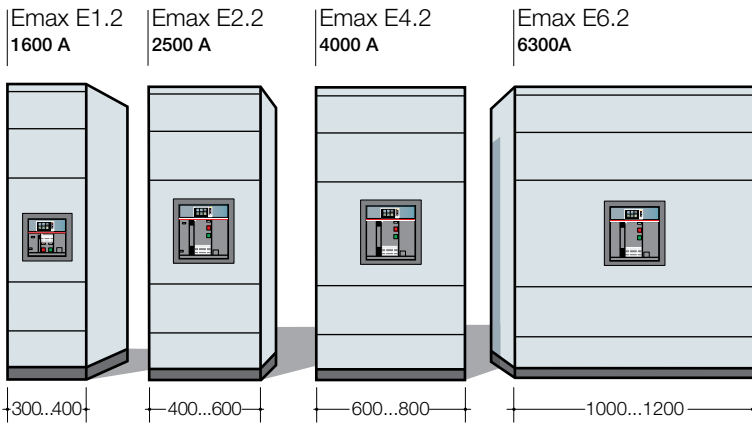

SACE Emax 2 circuit-breakers enable the design of electrical switchgear to be improved, optimisation in terms of performance and also in the use of the main materials:

- **Copper:** thanks to the possibility of developing compact units, the length of the distribution system/ busbar can be minimised.
- **Metal frame and structure:** reduced volumes also mean less surface space is used for panels and internal structures.
- **Space:** the optimisation of the individual units benefits the entire switchgear, which is more compact and can therefore be installed taking up less surface.

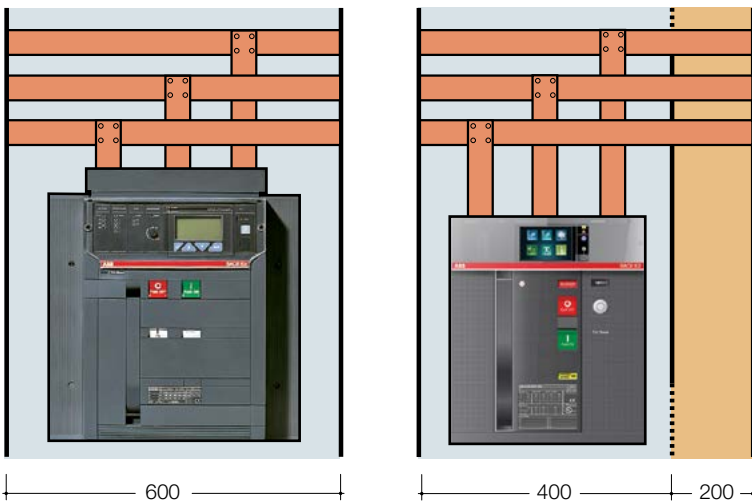

Efficiencies with Emax 2

- Compact design requires less copper
- Optimise and reduce usage of materials for metal frame, segregation and plates
- Reduce footprint via compact structure

Guide to selection

Icu (440Vac)	Versione	630	800	1000	1250	1600	2000	2500	3200	4000	5000	6300
200	X											
150	V											E6.2
100	H		E2.2						E4.2			
85	S		E2.2						E4.2			
66	N	E1.2		E2.2								
50	C	E1.2		E2.2								
42	B	E1.2		E2.2								

Switch-disconnectors

Icw (1s)	Version	630	800	1000	1250	1600	2000	2500	3200	4000	5000	6300
120	X											
100	V											E6.2
85	H		E2.2						E4.2			
66	N		E2.2						E4.2			
50	N	E1.2		E2.2								
42	B	E1.2		E2.2								

Air Circuit Breakers (ACB)

Emax 2 Series – ACB with Electronic Protection Unit (Ekip Dip LI)



3

ACB Rating	Emax model	Drawout type		Fixed Type	
		3-Pole + Cradle List Price (RM)	4-Pole + Cradle List Price (RM)	3-Pole List Price (RM)	4-Pole List Price (RM)
Icw (1s) = 66kA					
800A	E2.2N / 08	1SDA072241R1 + 1SDA073909R1 19,855.00	1SDA072871R1 + 1SDA073910R1 22,666.00	1SDA070891R1 17,193.00	1SDA071521R1 19,855.00
1000A	E2.2N / 10	1SDA072271R1 + 1SDA073909R1 20,463.00	1SDA072901R1 + 1SDA073910R1 22,882.00	1SDA070921R1 17,799.00	1SDA071551R1 20,463.00
1250 A	E2.2N / 12	1SDA072301R1 + 1SDA073909R1 21,822.00	1SDA072931R1 + 1SDA073910R1 25,547.00	1SDA070951R1 18,779.00	1SDA071581R1 21,822.00
1600 A	E2.2N / 16	1SDA072341R1 + 1SDA073909R1 22,778.00	1SDA072971R1 + 1SDA073910R1 26,639.00	1SDA070991R1 20,116.00	1SDA071621R1 22,778.00
2000 A	E2.2N / 20	1SDA072381R1 + 1SDA073909R1 31,463.00	1SDA073011R1 + 1SDA073910R1 35,721.00	1SDA071031R1 27,473.00	1SDA071661R1 29,115.00
2500 A	E2.2N / 25	1SDA072411R1 + 1SDA073911R1 36,544.00	1SDA073041R1 + 1SDA073912R1 41,434.00	1SDA071061R1 33,481.00	1SDA071691R1 35,522.00
3200 A	E4.2N / 32	1SDA072491R1 + 1SDA073913R1 42,929.00	1SDA073121R1 + 1SDA073914R1 49,692.00	1SDA071141R1 40,379.00	1SDA071771R1 42,929.00
4000 A	E4.2N / 40	1SDA072541R1 + 1SDA073915R1 48,675.00	1SDA073171R1 + 1SDA073916R1 66,575.00	1SDA071191R1 49,570.00	1SDA071821R1 57,226.00
Icw (1s) = 100kA					
5000 A	E6.2H / 50	1SDA072611R1 + 1SDA073917R1 130,379.00	1SDA073331R1 + 1SDA073919R1 158,000.00	1SDA071261R1 115,359.00	1SDA071981R1 134,477.00
6300 A	E6.2H / 63	1SDA072641R1 + 1SDA073920R1 167,976.00	1SDA073361R1 + 1SDA073922R1 199,025.00	1SDA071291R1 158,733.00	1SDA072011R1 180,689.00

Standard Accessories for ACB Drawout Version

- 1) IP30 Door Flange
- 2) Lifting Plates for E2.2 ... E6.2 Circuit-Breaker
- 3) Adjustable Rear Terminals for Cradle, Mounted In HR – HR Configuration
- 3) 4 Auxiliary Change-Over Contacts (Included)
- 4) Shunt Opening Release (1SDA073675R1)

Standard Accessories for ACB Fixed Version

- 1) IP30 Door Flange
- 2) Lifting plates for E2.2 ... E6.2 circuit-breaker
- 3) Adjustable Rear Terminals for Circuit-Breaker, Mounted In HR – HR Configuration
- 4) 4 Auxiliary Change-Over Contacts (Included)
- 5) Shunt Opening Release (1SDA073675R1)

Air Circuit Breakers (ACB)

Emax 2 Series – Switch Disconnectors (Without protection trip unit)



ACB Rating	Emax model	Drawout type		Fixed Type	
		3-Pole + Cradle List Price (RM)	4-Pole + Cradle List Price (RM)	3-Pole List Price (RM)	4-Pole List Price (RM)
Icw (1s) = 66kA					
800A	E2.2N / 08	1SDA082157R1 + 1SDA073909R1 14,224.00	1SDA082165R1 + 1SDA073910R1 16,953.00	1SDA073402R1 11,639.00	1SDA073441R1 14,224.00
1000A	E2.2N / 10	1SDA082158R1 + 1SDA073909R1 14,813.00	1SDA082171R1 + 1SDA073910R1 17,163.00	1SDA073404R1 12,228.00	1SDA073443R1 14,813.00
1250 A	E2.2N / 12	1SDA082159R1 + 1SDA073909R1 16,134.00	1SDA082172R1 + 1SDA073910R1 19,749.00	1SDA073406R1 13,179.00	1SDA073445R1 16,134.00
1600 A	E2.2N / 16	1SDA082160R1 + 1SDA073909R1 17,062.00	1SDA082173R1 + 1SDA073910R1 20,810.00	1SDA073409R1 14,478.00	1SDA073448R1 17,062.00
2000 A	2000 A	1SDA082161R1 + 1SDA073909R1 25,495.00	1SDA082174R1 + 1SDA073910R1 29,628.00	1SDA073412R1 21,621.00	1SDA073451R1 23,213.00
2500 A	E2.2N / 25	1SDA082162R1 + 1SDA073911R1 30,427.00	1SDA082175R1 + 1SDA073912R1 35,174.00	1SDA073414R1 27,454.00	1SDA073453R1 29,435.00
3200 A	E4.2N / 32	1SDA082163R1 + 1SDA073913R1 36,627.00	1SDA082176R1 + 1SDA073914R1 43,193.00	1SDA073418R1 34,151.00	1SDA073457R1 36,627.00
4000 A	E4.2N / 40	1SDA082164R1 + 1SDA073915R1 42,204.00	1SDA082177R1 + 1SDA073916R1 54,330.00	1SDA073421R1 43,073.00	1SDA073460R1 50,433.00
Icw (1s) = 100kA					
5000 A	E6.2H / 50	1SDA073510R1 + 1SDA073917R1 125,327.00	1SDA073555R1 + 1SDA073919R1 152,948.00	1SDA073426R1 110,306.00	1SDA073471R1 129,425.00
6300 A	E6.2H / 63	1SDA073512R1 + 1SDA073920R1 162,924.00	1SDA073557R1 + 1SDA073922R1 193,973.00	1SDA073428R1 153,681.00	1SDA073473R1 175,637.00

Standard Accessories for Switch-Disconnectors Drawout Version









- 1) IP30 Door Flange
- 2) Lifting Plates for E2.2 ... E6.2 Circuit-Breaker
- 3) Adjustable Rear Terminals for Cradle, Mounted In HR – HR Configuration
- 3) 4 Auxiliary Change-Over Contacts (1SDA073753R1)
- 4) Shunt Opening Release (1SDA073675R1)

Standard Accessories for Switch-Disconnectors Fixed Version

- 1) IP30 Door Flange
- 2) Lifting plates for E2.2 ... E6.2 circuit-breaker
- 3) Adjustable Rear Terminals for Circuit-Breaker, Mounted In HR – HR Configuration
- 4) 4 Auxiliary Change-Over Contacts (1SDA073753R1)
- 5) Shunt Opening Release (1SDA073675R1)

Air Circuit Breakers (ACB) Accessories

Accessories for Emax ACB E2.2 – E4.2 – E6.2

Type	Description	Order Code	List Price (RM)
	Opening release (Shunt Tripping device)	240V...250V 50Hz AC / DC 1SDA073675R1	890.00
	Closing release (Shunt Closing device)	240V...250V 50Hz AC / DC 1SDA073688R1	890.00
	Gearmotor for Automatic Loading of closing spring (requires shunt closing device above)	220V...250V 50Hz AC / DC 1SDA073725R1	5,392.00
	Undervoltage Release	415V...440V 50Hz AC / DC 1SDA073704R1	1,197.00
		240V...250V 50Hz AC / DC 1SDA073701R1	1,197.00
	Mechanical Operation Counter	1SDA073781R1	437.00
	Key Lock in Open position (Same Key)	1SDA073792R1	546.00
	Key Lock in Open position (Different Key)	1SDA073791R1	546.00
	IP54 Flange (Different Keys)	1SDA073867R1	1,792.00
	IP54 Flange (key No.20005)	1SDA073869R1	1,792.00
	PB Separators 2pcs E2.2..E6.2 F 3P	1SDA076166R1	199.00
	PB Separators 3pcs E2.2..E6.2 F 4P	1SDA076167R1	285.00
	PB Separators 2pcs E2.2..E6.2 W FP 3P	1SDA076168R1	199.00
	PB Separators 3pcs E2.2..E6.2 W FP 4P	1SDA076169R1	285.00
	PLC E2.2..E6.2 Padlocks in open position D=4mm	1SDA073803R1	355.00
	PLC E2.2..E6.2 Padlocks in open position D=7mm	1SDA073804R1	355.00
	PLC E2.2..E6.2 Padlocks in open position D=8mm	1SDA073805R1	355.00

Air Circuit Breakers (ACB) Accessories

Mechanical accessories for Emax2 Series ACB E2.2...E6.2

Mechanical Interlock

[Group 1] Cables for mechanical interlock

Size	Type	Order Code	List Price (RM)
E2.2...E6.2	Type A horizontal	1SDA073881R1	1,545.00
E2.2...E6.2	Type B,C,D horizontal	1SDA073882R1	1,545.00
E2.2...E6.2	Type A vertical	1SDA073885R1	1,545.00
E2.2...E6.2	Type B,C,D vertical	1SDA073886R1	1,545.00

Order one type of cable for each interlock. The cable must be ordered on the fixed circuit breaker or on the fixed part of withdrawable circuit breaker.

[Group 2] Lever for mechanical interlock of fixed circuit-breaker or mobile part

Size	Type	Order Code	List Price (RM)
E2.2	Lever for mechanical interlock – 3 Poles	1SDA073889R1	773.00
	Lever for mechanical interlock – 4 Poles	1SDA073889R1	773.00
E4.2	Lever for mechanical interlock – 3 Poles	1SDA073890R1	773.00
	Lever for mechanical interlock – 4 Poles	1SDA073890R1	773.00
E6.2	Lever for mechanical interlock – 3 Poles	1SDA073891R1	773.00
	Lever for mechanical interlock – 4 Poles	1SDA073892R1	773.00

[Group 3] Support for mechanical interlock of fixed circuit-breaker

Size	Type	Order Code	List Price (RM)
E2.2...E6.2	Type A / B / D	1SDA073895R1	979.00
E2.2...E6.2	Type C	1SDA073897R1	979.00

[Group 4] Support for mechanical interlock of fixed part

Size	Type	Order Code	List Price (RM)
E2.2...E6.2	Type A / B / D	1SDA073895R1	979.00
E2.2...E6.2	Type C	1SDA073897R1	979.00

Air Circuit Breakers (ACB) Accessories

Mechanical Interlock selection guide

1. Interlock between two fixed circuit-breakers

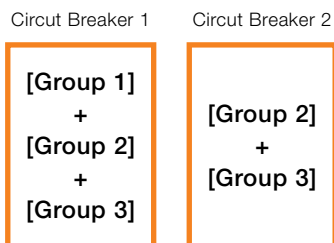

2. Interlock between three fixed circuit-breakers

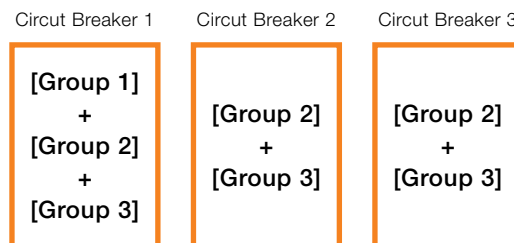

3. Interlock between two withdrawable circuit-breakers

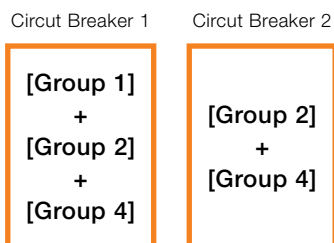

4. Interlock between three withdrawable circuit-breakers

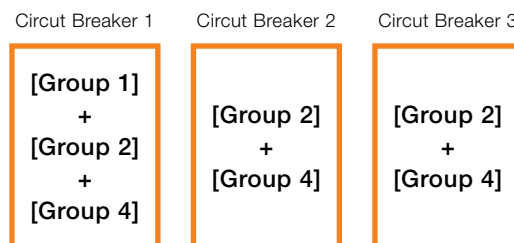

Ordering Example

The following item must be ordered for mechanical interlocks.

1) Interlock between two withdrawable type A horizontal, 3 poles circuit-breakers:

E4.2 & E2.2 and are placed horizontal in the switchboard.

E4.2 withdrawable circuit-breaker

[Group 1] Cables for mechanical interlock – Type A horizontal	1SDA073881R1	x 1 pcs
+		
[Group 2] Lever for mechanical interlock of fixed circuit-breaker or mobile part Lever for mechanical interlock – 3 Poles	1SDA073890R1	x 1 pcs
+		
[Group 4] Support for mechanical interlock of fixed part – Type A / B / D	1SDA073895R1	x 1 pcs

E2.2 withdrawable circuit-breaker

[Group 2] Lever for mechanical interlock of fixed circuit-breaker or mobile part Lever for mechanical interlock – 3 Poles	1SDA073889R1	x 1 pcs
+		
[Group 4] Support for mechanical interlock of fixed part – Type A / B / D	1SDA073895R1	x 1 pcs

Note: All of the above examples of ordering mechanical interlock accessories are for E2.2, E4.2 and E6.2 circuit-breaker only. For E1.2, please consult ABB.

A series of horizontal dotted lines for writing.

Switches



Switch-disconnectors/Isolators/Load Break Switches

Accessories overview

OT16F...OT125F

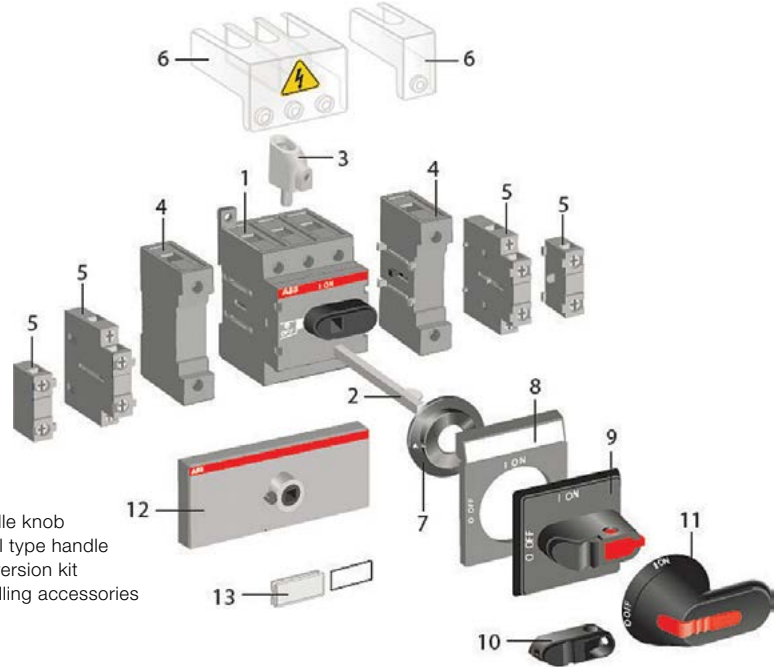

- | | | |
|-------------------------------------|-------------------------|---------------------------|
| 1. Switch-disconnector | 7. Shaft alignment ring | 10. Handle knob |
| 2. Extended shaft | 8. Legend plate | 11. Pistol type handle |
| 3. Terminal clamp | 5. Auxiliary contact | 12. Conversion kit |
| 4. Fourth pole, N- And PE terminals | 6. Terminal shroud | 13. Labelling accessories |
| 5. Auxiliary contact | 7. Shaft alignment ring | |
| 6. Terminal shroud | 8. Legend plate | |
| | 9. Selector type handle | |

OT16FT...OT125FT

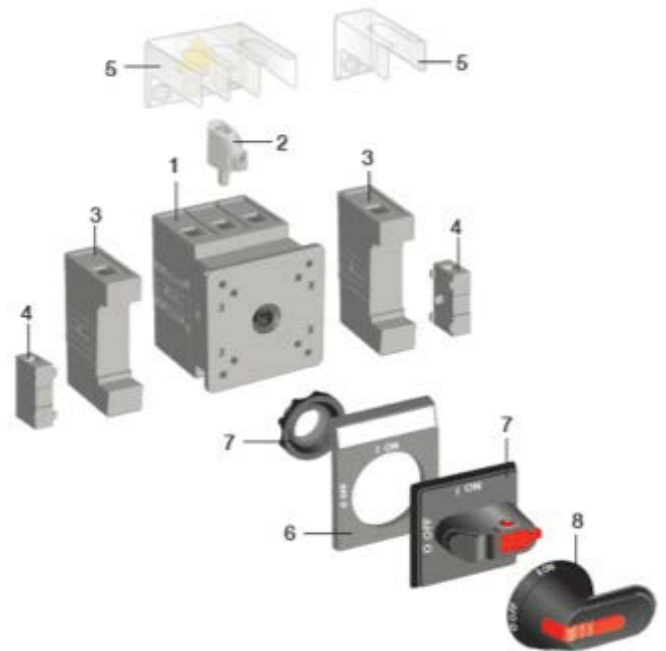

- | | |
|-------------------------------------|-------------------------|
| 1. Switch-disconnector | 5. Terminal shroud |
| 2. Terminal clamp | 6. Legend plate |
| 3. Fourth pole, N- And PE terminals | 7. Selector type handle |
| 4. Auxiliary contact | 8. Pistol type handle |

Switch-disconnectors/Isolators/Load Break Switches

Accessories overview

OT160EV...OT1600

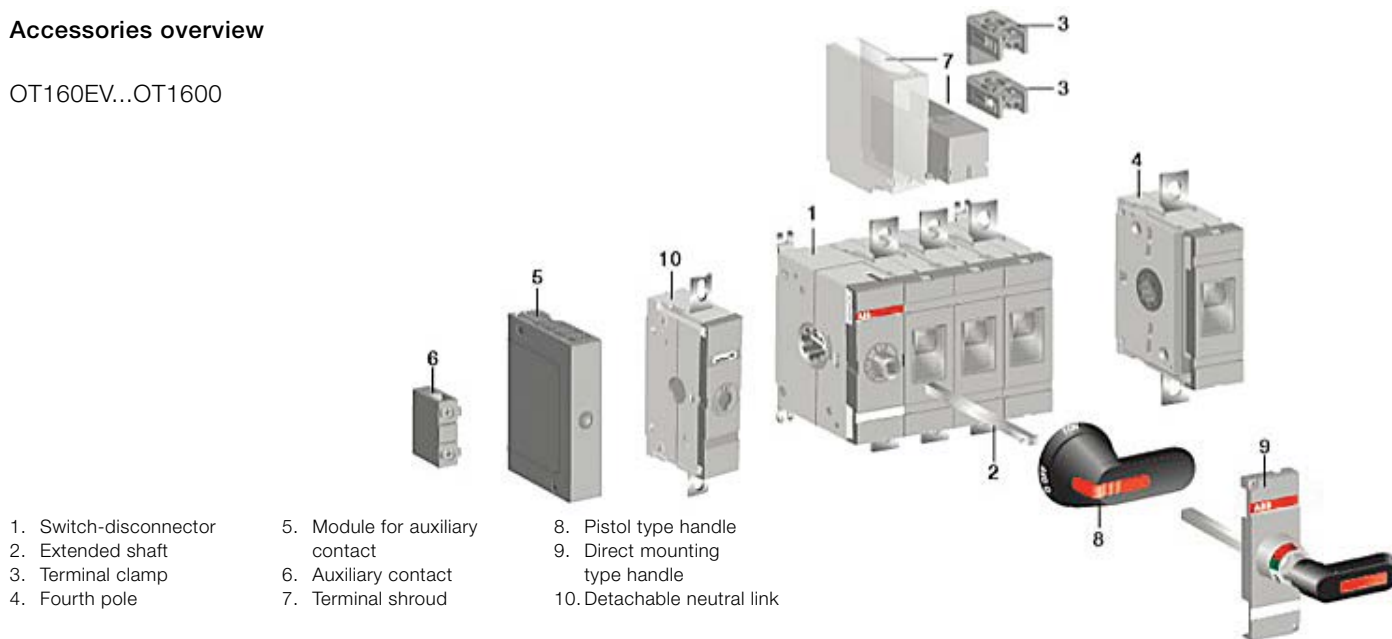

OT2000...OT4000

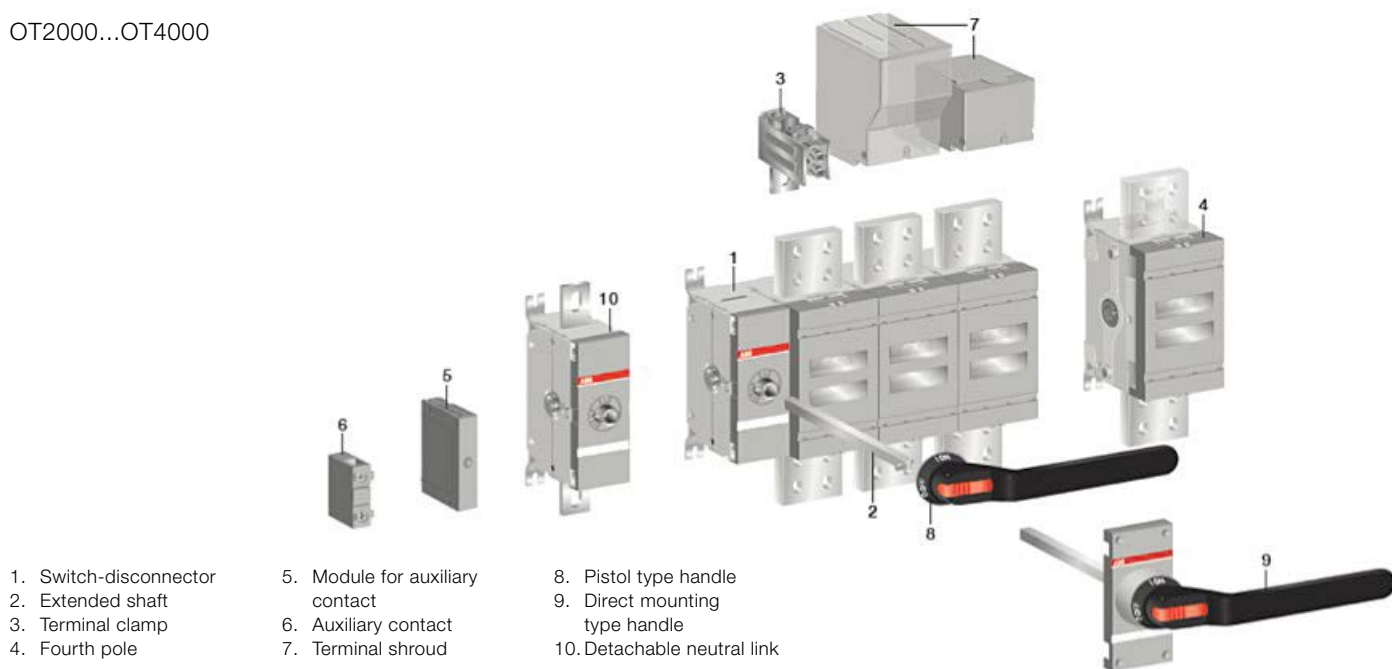

Switch-disconnectors/Isolators/Load Break Switches

OT series

3 Poles



Current Rating (A)	Description	Order Code	List Price (RM)	Require Quantity	Total List Price (RM)
16	OT16F3	1SCA104811R1001	112.00	1	207.00
	OHBS2AJ1	1SCA105215R1001	55.00	1	
	OXS6X130	1SCA101655R1001	40.00	1	
25	OT25F3	1SCA104857R1001	112.00	1	207.00
	OHBS2AJ1	1SCA105215R1001	55.00	1	
	OXS6X130	1SCA101655R1001	40.00	1	
40	OT40F3	1SCA104902R1001	128.00	1	223.00
	OHBS2AJ1	1SCA105215R1001	55.00	1	
	OXS6X130	1SCA101655R1001	40.00	1	
63	OT63F3	1SCA105332R1001	181.00	1	276.00
	OHBS2AJ1	1SCA105215R1001	55.00	1	
	OXS6X130	1SCA101655R1001	40.00	1	
80	OT80F3	1SCA105798R1001	241.00	1	336.00
	OHBS2AJ1	1SCA105215R1001	55.00	1	
	OXS6X130	1SCA101655R1001	40.00	1	
100	OT100F3	1SCA105004R1001	296.00	1	391.00
	OHBS2AJ1	1SCA105215R1001	55.00	1	
	OXS6X130	1SCA101655R1001	40.00	1	
125	OT125F3	1SCA105033R1001	366.00	1	461.00
	OHBS2AJ1	1SCA105215R1001	55.00	1	
	OXS6X130	1SCA101655R1001	40.00	1	

* Complusary to include OT series with standard accessories as above table, please follow while ordering



3 Poles

Current Rating (A)	Description	Order Code	Total List Price (RM)
160	OT160EV03P	1SCA120514R1001	632.00
200	OT200E03P	1SCA022712R0800	987.00
250	OT250E03P	1SCA022710R0100	1,094.00
315	OT315E03P	1SCA022718R8510	1,350.00
400	OT400E03P	1SCA022718R8780	1,749.00
630	OT630E03P	1SCA022718R8940	2,398.00
800	OT800E03P	1SCA022718R9410	3,747.00
1000	OT1000E03P	1SCA022860R5930	5,475.00
1250	OT1250E03P	1SCA022860R6230	6,123.00
1600	OT1600E03P	1SCA022860R6580	9,024.00
2000	OT2000E03P	1SCA108036R1001	11,982.00
2500	OT2500E03P	1SCA104972R1001	14,266.00
3200	OT3200E03P	1SCA128481R1001	28,391.00
3800	OT4000E03P	1SCA124848R1001	40,140.00

Note: Motorized switch disconnecter is available upon request (160A – 2500A).



Switch-disconnectors/Isolators/Load Break Switches



OT series 4 Poles

Current Rating (A)	Type	Order Code	List Price (RM)	Require Quantity	Total List Price (RM)
16	OT16F4N2	1SCA104829R1001	153.00	1	248.00
	OHBS2AJ1	1SCA105215R1001	55.00	1	
	OXS6X130	1SCA101655R1001	40.00	1	
25	OT25F4N2	1SCA104886R1001	153.00	1	248.00
	OHBS2AJ1	1SCA105215R1001	55.00	1	
	OXS6X130	1SCA101655R1001	40.00	1	
40	OT40F4N2	1SCA104932R1001	185.00	1	280.00
	OHBS2AJ1	1SCA105215R1001	55.00	1	
	OXS6X130	1SCA101655R1001	40.00	1	
63	OT63F4N2	1SCA105365R1001	271.00	1	366.00
	OHBS2AJ1	1SCA105215R1001	55.00	1	
	OXS6X130	1SCA101655R1001	40.00	1	
80	OT80F4N2	1SCA105413R1001	319.00	1	414.00
	OHBS2AJ1	1SCA105215R1001	55.00	1	
	OXS6X130	1SCA101655R1001	40.00	1	
100	OT100F4N2	1SCA105018R1001	461.00	1	556.00
	OHBS2AJ1	1SCA105215R1001	55.00	1	
	OXS6X130	1SCA101655R1001	40.00	1	
125	OT125F4N2	1SCA105051R1001	500.00	1	595.00
	OHBS2AJ1	1SCA105215R1001	55.00	1	
	OXS6X130	1SCA101655R1001	40.00	1	

* Complusary to include OT series with standard accessories as above table, please follow while ordering



4 Poles

Current Rating (A)	Description	Order Code	Total List Price (RM)
160	OT160EV04P	1SCA120521R1001	869.00
200	OT200E04P	1SCA022713R4930	1,144.00
250	OT250E04P	1SCA022710R0520	1,283.00
315	OT315E04P	1SCA022719R1730	1,648.00
400	OT400E04P	1SCA022719R1810	2,169.00
630	OT630E04P	1SCA022719R2030	3,063.00
800	OT800E04P	1SCA022719R2110	4,494.00
1000	OT1000E04P	1SCA022860R6150	5,992.00
1250	OT1250E04P	1SCA022860R6310	6,741.00
1600	OT1600E04P	1SCA022860R6740	10,111.00
2000	OT2000E04P	1SCA108038R1001	13,480.00
2500	OT2500E04P	1SCA105140R1001	17,410.00
3200	OT3200E04P	1SCA128482R1001	34,859.00
3800	OT4000E04P	1SCA124856R1001	47,533.00

Note: Motorized switch disconnecter is available upon request (160A – 2500A).



*NOTE: All List Prices Excluding 6% GST

Manual Change-over Switches

Accessories overview

OT16F...OT125F_C

Technical Description:

- 1) Used in transferring one or more loads from one supply to another
- 2) Range: 16A to 2500A, 3-poles and 4-poles

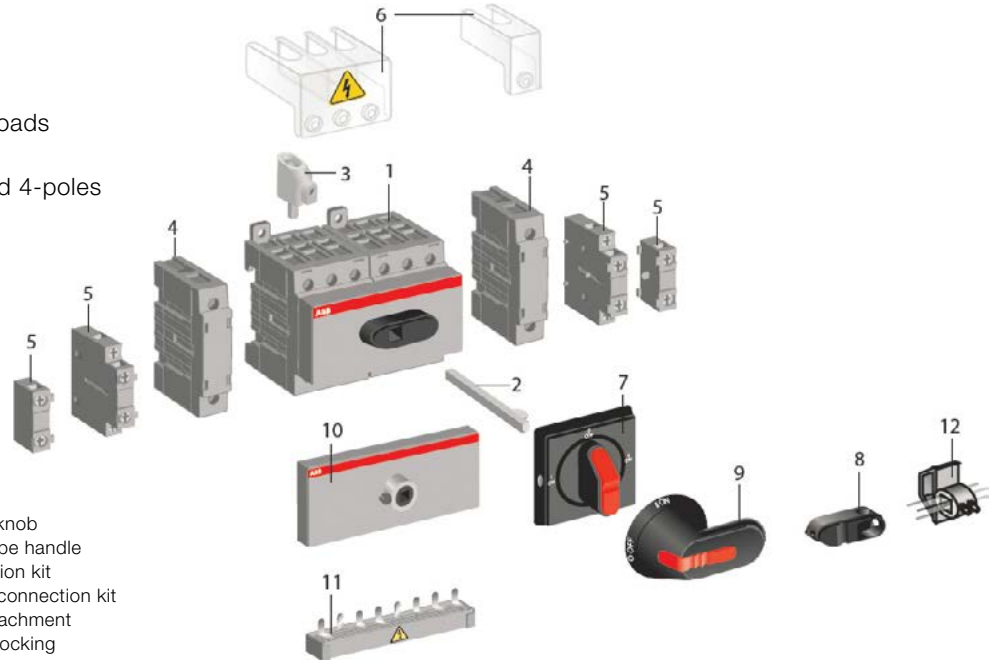

- | | |
|------------------------------|-------------------------------------|
| 1. Manual change-over switch | 8. Handle knob |
| 2. Extended shaft | 9. Pistol type handle |
| 3. Terminal clamp | 10. Conversion kit |
| 4. Fourth pole | 11. Parallel connection kit |
| 5. Auxiliary contact | 12. Cam attachment for interlocking |
| 6. Terminal shroud | |
| 7. Selector type handle | |

OT160...2500_C

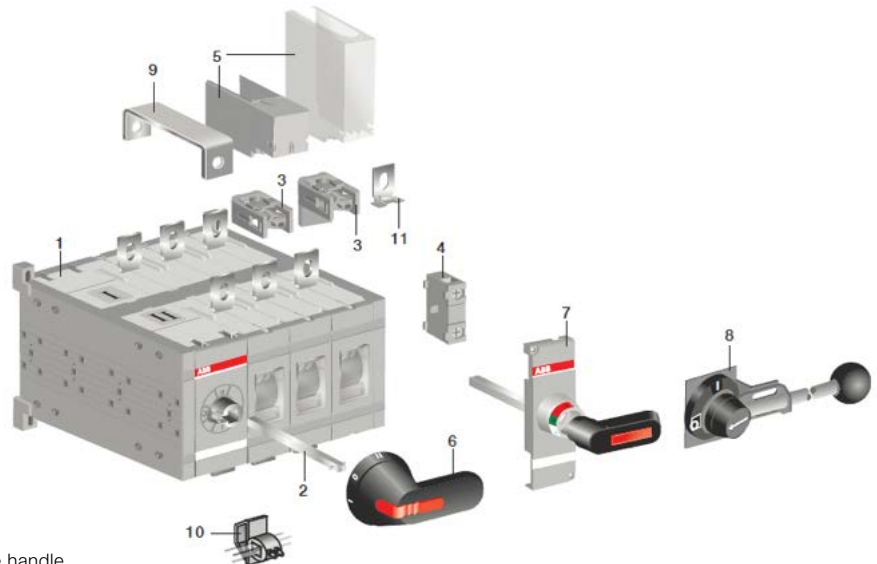

- | | |
|------------------------------|-------------------------------------|
| 1. Manual change-over switch | 7. Direct mounting type handle |
| 2. Extended shaft | 8. Metallic knob |
| 3. Terminal clamp | 9. Bridging bar |
| 4. Auxiliary contact | 10. Cam attachment for interlocking |
| 5. Terminal shroud | 11. Voltage sensing connector |
| 6. Pistol type handle | |

Manual Change-over Switches

Accessories overview

OT3200_C

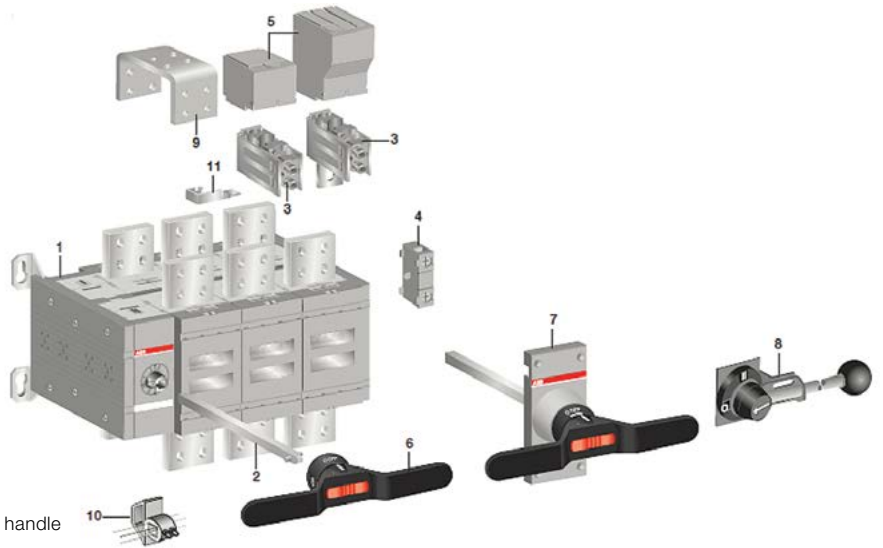

- 1. Manual change-over switch
- 2. Extended shaft
- 3. Terminal clamp
- 4. Auxiliary contact
- 5. Terminal shroud
- 6. Pistol type handle
- 7. Direct mounting type handle
- 8. Metallic knob
- 9. Bridging bar
- 10. Cam attachment for interlocking
- 11. Voltage sensing connector

Manual Change-over Switches

OT_c series



4 Poles

Current Rating (A)	Type	Order Code	List Price (RM)	Require Quantity	Total List Price (RM)
16	OT16F4C	1SCA104831R1001	583.00	1	703.00
	OHBS2AJE011	1SCA105220R1001	80.00	1	
	OXS6X130	1SCA101655R1001	40.00	1	
25	OT25F4C	1SCA104877R1001	660.00	1	780.00
	OHBS2AJE011	1SCA105220R1001	80.00	1	
	OXS6X130	1SCA101655R1001	40.00	1	
40	OT40F4C	1SCA104934R1001	747.00	1	867.00
	OHBS2AJE011	1SCA105220R1001	80.00	1	
	OXS6X130	1SCA101655R1001	40.00	1	
63	OT63F4C	1SCA105369R1001	1,160.00	1	1,280.00
	OHBS2AJE011	1SCA105220R1001	80.00	1	
	OXS6X130	1SCA101655R1001	40.00	1	
80	OT80F4C	1SCA105418R1001	1,249.00	1	1,369.00
	OHBS2AJE011	1SCA105220R1001	80.00	1	
	OXS6X130	1SCA101655R1001	40.00	1	
100	OT100F4C	1SCA105019R1001	1,381.00	1	1,501.00
	OHBS2AJE011	1SCA105220R1001	80.00	1	
	OXS6X130	1SCA101655R1001	40.00	1	
125	OT125F4C	1SCA105054R1001	1,559.00	1	1,679.00
	OHBS2AJE011	1SCA105220R1001	80.00	1	
	OXS6X130	1SCA101655R1001	40.00	1	

* Complusary to include OT_c series with standard accessories as above table, please follow while ordering

4 Poles

Current Rating (A)	Description	Order Code	Total List Price (RM)
160	OT160E04CP	1SCA022775R9440	2,398.00
200	OT200E04CP	1SCA022771R7280	2,548.00
250	OT250E04CP	1SCA022775R4640	3,063.00
315	OT315E04CP	1SCA022775R7150	3,823.00
400	OT400E04CP	1SCA022771R8680	4,045.00
630	OT630E04CP	1SCA022785R6130	5,243.00
800	OT800E04CP	1SCA022785R6210	7,864.00
1000	OT1000E04CP	1SCA022872R1500	11,607.00
1250	OT1250E04CP	1SCA022872R1250	12,356.00
1600	OT1600E04CP	1SCA022872R2310	18,533.00
2000	OT2000E04CP	1SCA103912R1001	31,283.00
2500	OT2500E04CP	1SCA103906R1001	33,323.00
3200	OT3200E04CP	1SCA129158R1001	66,537.00

Motorized Change-over Switches

Accessories overview

OTM40F...OTM125F_c

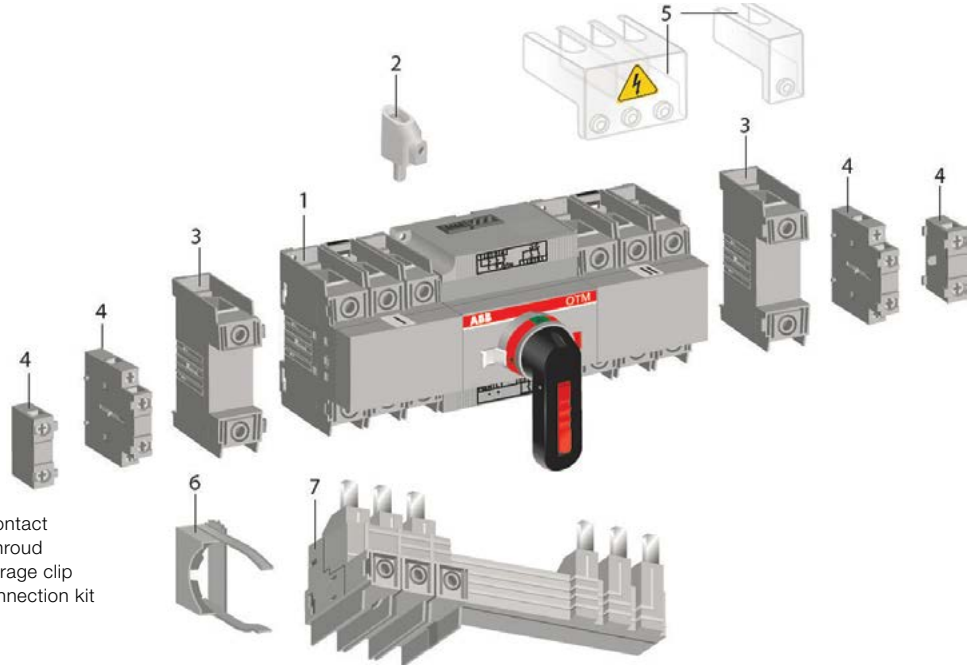

- 1. Motorized change-over switch
- 2. Terminal clamp set
- 3. Fourth pole
- 4. Auxiliary contact
- 5. Terminal shroud
- 6. Handle storage clip
- 7. Parallel connection kit

4

OTM160...OTM2500_c

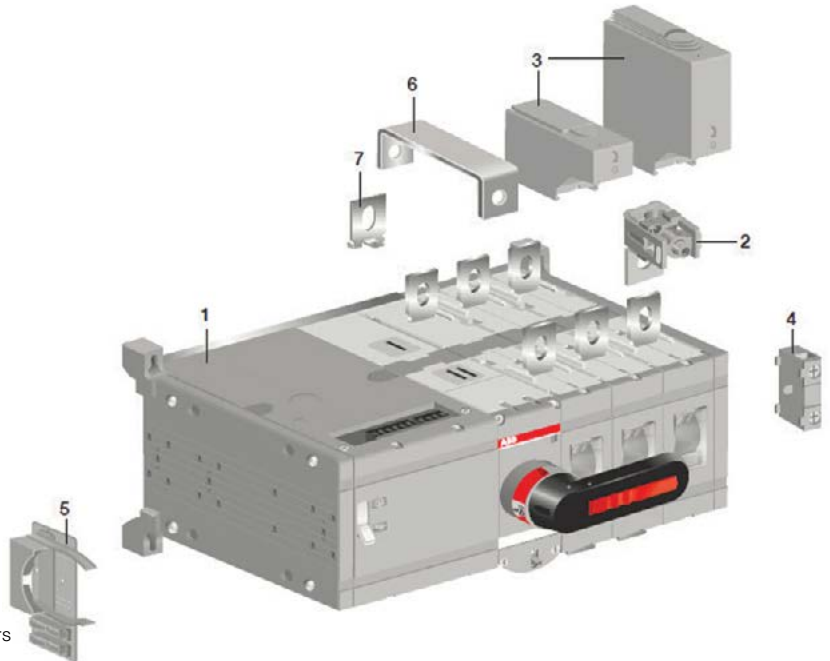

- 1. Motorized change-over switch
- 2. Terminal clamp set
- 3. Terminal shroud
- 4. Auxiliary contact
- 5. Handle and spare fuse storage clip
- 6. Bridging bar
- 7. Voltage sensing connectors

Motorized Change-over Switches

OTM_c series



OTM40 – 125_c, 4 Poles

Current Rating (A)	Type	Order Code	List Price (RM)	Require Quantity	Total List Price (RM)
40	OTM40F4CMA230V	1SCA120102R1001	3,794.00	1	4,070.00
	OA1G10	1SCA022353R4970	69.00	2	
	OA1G01	1SCA022353R4890	69.00	2	
63	OTM63F4CMA230V	1SCA120101R1001	4,216.00	1	4,492.00
	OA1G10	1SCA022353R4970	69.00	2	
	OA1G01	1SCA022353R4890	69.00	2	
80	OTM80F4CMA230V	1SCA120100R1001	4,636.00	1	4,912.00
	OA1G10	1SCA022353R4970	69.00	2	
	OA1G01	1SCA022353R4890	69.00	2	
100	OTM100F4CMA230V	1SCA120098R1001	4,888.00	1	5,164.00
	OA1G10	1SCA022353R4970	69.00	2	
	OA1G01	1SCA022353R4890	69.00	2	
125	OTM125F4CMA230V	1SCA120097R1001	5,877.00	1	6,153.00
	OA1G10	1SCA022353R4970	69.00	2	
	OA1G01	1SCA022353R4890	69.00	2	

Compulsory to included OTM_c series with standard accessories as above table, please follow while ordering

Motorized Change-over Switches

OTM_c series



4

OTM160 – 2500_c, 4 Poles

Current Rating (A)	Type	Order Code	List Price (RM)	Require Quantity	Total List Price (RM)
160	OTM160E4CM230C	1SCA022848R1510	7,043.00	1	7,319.00
	OA1G10	1SCA022353R4970	69.00	2	
	OA3G01	1SCA022456R7410	69.00	2	
200	OTM200E4CM230C	1SCA022846R1590	8,343.00	1	8,619.00
	OA1G10	1SCA022353R4970	69.00	2	
	OA3G01	1SCA022456R7410	69.00	2	
250	OTM250E4CM230C	1SCA022846R1910	9,014.00	1	9,290.00
	OA1G10	1SCA022353R4970	69.00	2	
	OA3G01	1SCA022456R7410	69.00	2	
315	OTM315E4CM230C	1SCA022847R2870	9,999.00	1	10,275.00
	OA1G10	1SCA022353R4970	69.00	2	
	OA3G01	1SCA022456R7410	69.00	2	
400	OTM400E4CM230C	1SCA022847R3250	11,142.00	1	11,418.00
	OA1G10	1SCA022353R4970	69.00	2	
	OA3G01	1SCA022456R7410	69.00	2	
630	OTM630E4CM230C	1SCA022873R1990	16,008.00	1	16,284.00
	OA1G10	1SCA022353R4970	69.00	2	
	OA3G01	1SCA022456R7410	69.00	2	
800	OTM800E4CM230C	1SCA022872R8340	23,792.00	1	24,068.00
	OA1G10	1SCA022353R4970	69.00	2	
	OA3G01	1SCA022456R7410	69.00	2	
1000	OTM1000E4CM230C	1SCA112703R1001	26,938.00	1	27,214.00
	OA1G10	1SCA022353R4970	69.00	2	
	OA3G01	1SCA022456R7410	69.00	2	
1250	OTM1250E4CM230C	1SCA112702R1001	28,738.00	1	29,014.00
	OA1G10	1SCA022353R4970	69.00	2	
	OA3G01	1SCA022456R7410	69.00	2	
1600	OTM1600E4CM230C	1SCA112704R1001	38,471.00	1	38,747.00
	OA1G10	1SCA022353R4970	69.00	2	
	OA3G01	1SCA022456R7410	69.00	2	
2000	OTM2000E4CM230C	1SCA112712R1001	52,602.00	1	52,878.00
	OA1G10	1SCA022353R4970	69.00	2	
	OA3G01	1SCA022456R7410	69.00	2	
2500	OTM2500E4CM230C	1SCA112713R1001	61,684.00	1	61,960.00
	OA1G10	1SCA022353R4970	69.00	2	
	OA3G01	1SCA022456R7410	69.00	2	

Compulsory to included OTM_c series with standard accessories as above table, please follow while ordering.

*NOTE: All List Prices Excluding 6% GST

Switch Fuses

Accessories overview

OS32G...OS63G

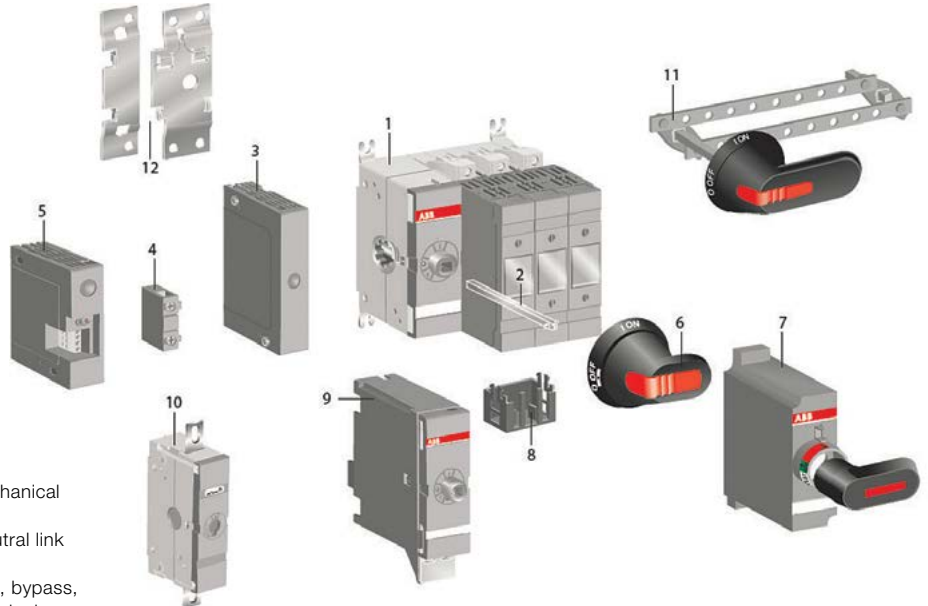

- | | |
|---------------------------------|---|
| 1. Switch fuse | 9. Interlocks, mechanical and electrical |
| 2. Extended shaft | 10. Detachable neutral link |
| 3. Module for auxiliary contact | 11. Conversion kit:
6 / 8-pole, C/O, bypass,
mechanical interlock |
| 4. Auxiliary contact | 12. DIN rail mounting kit |
| 5. Fuse monitor | |
| 6. Pistol type handle | |
| 7. Direct mounted handle | |
| 8. Blown fuse indicator | |

OS100G – OS1250

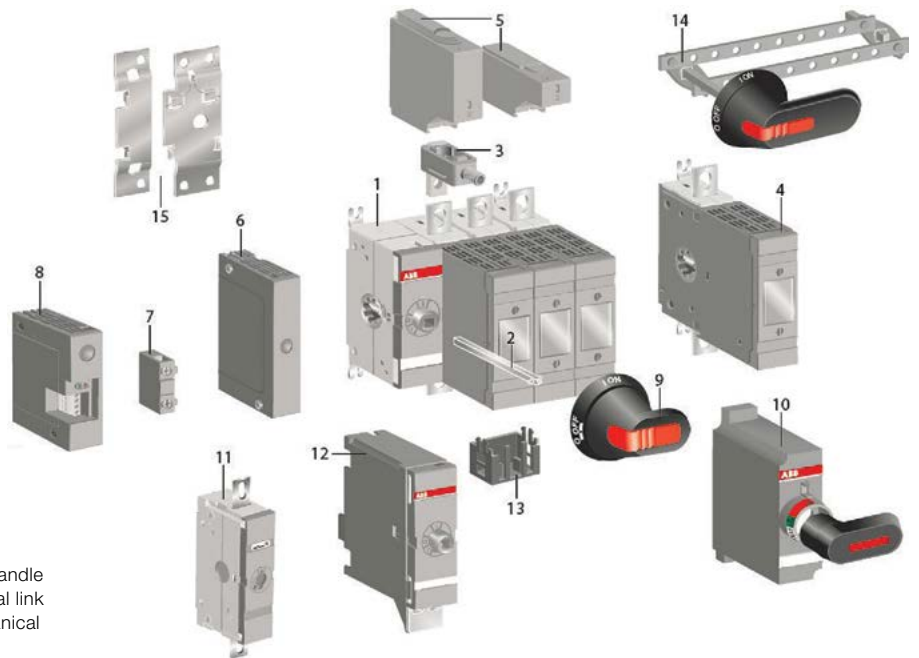

- | | |
|----------------------------------|---|
| 1. Switch fuse | 10. Direct mounted handle |
| 2. Extended shaft | 11. Detachable neutral link |
| 3. Terminal clamp | 12. Interlocks, mechanical and electrical |
| 4. Fourth pole | 13. Blown fuse indicator |
| 5. Terminal shroud | 14. Conversion kit:
6 / 8-pole, C/O, bypass,
mechanical interlock |
| 6. Module for auxiliary contacts | 15. DIN rail mounting kit (only
for OS100G – OS160G_) |
| 7. Auxiliary contact | |
| 8. Fuse monitor | |
| 9. Pistol type handle | |

Switch Fuses

OS series

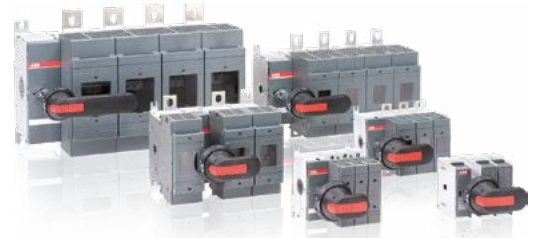

4

3 Poles

Current Rating (A)	Fuse Size	Type	Order Code	List Price (RM)
32	000	OS32GD12P	1SCA114581R1001	1,085.00
63	000	OS63GD12P	1SCA115227R1001	1,085.00
125	00	OS125GD12P	1SCA115641R1001	1,085.00
160	00	OS160GD12P	1SCA115643R1001	1,578.00
200	0	OS200D12P	1SCA022721R3050	1,972.00
250	0-1	OS250D12P	1SCA022726R8380	2,564.00
400	0-2	OS400D12P	1SCA022753R3800	4,455.00
630	3	OS630D12P	1SCA022825R3810	7,017.00
800	3	OS800D12P	1SCA022825R5340	11,825.00
1250	4	OS1250D12P	1SCA105246R1001	17,538.00







4 Poles

Current Rating (A)	Fuse Size	Type	Order Code	List Price (RM)
32	000	OS32GD22N2P	1SCA115202R1001	1,519.00
63	000	OS63GD22N2P	1SCA115230R1001	1,519.00
125	00	OS125GD22N2P	1SCA115880R1001	1,519.00
160	00	OS160GD22N2P	1SCA115884R1001	1,972.00
200	0	OS200D22N2P	1SCA022721R3130	2,773.00
250	0-1	OS250D22N2P	1SCA022726R8460	3,903.00
400	0-2	OS400D22N2P	1SCA022753R1770	5,914.00
630	3	OS630D22N2P	1SCA022825R4450	9,459.00
800	3	OS800D22N2P	1SCA022825R5510	15,765.00
1250	4	OS1250D22N2P	1SCA107933R1001	23,252.00

Note: Motorized switch disconnecter is available upon request (32A – 1250A).

Switches

Accessories for Switches

Category	Type	Order Code	List Price (RM)
Auxiliary Contacts 	Mountable on left side, max. 2 pcs		
	OA1G01, 1NC for OT16...OT125F_, FT_	1SCA022353R4890	69.00
	Mountable on the right side, max. 2 pcs		
	OA1G10, 1NO for OT16...OT125F_, FT_	1SCA022353R4970	69.00
	OA1G10, 1NO for OT160EV...4000	1SCA022353R4970	69.00
	OA3G01, 1NC for OT160EV...4000	1SCA022456R7410	69.00
Module for Auxiliary Contact 	OEA28, for OT160EV...2500	1SCA022714R8810	67.00
Handle 	Selector type handles, for base and DIN-rail mounted switches		
	OHBS2AJ1, selector type black handle, IP65	1SCA105215R1001	55.00
	Selector handle, indication I-O-II		
	OHBS2AJE011, for OT16...125F_C, OHB274J12E011, with metal insert, for OT1000...2500_c	1SCA105220R1001 1SCA122306R1001	80.00 476.00
Shaft 	OXS6X130, shaft 130mm length, 6mm diameter	1SCA101655R1001	40.00
	OXS6X180, shaft 180mm length, 6mm diameter	1SCA101659R1001	45.00
Fourth Poles 	OTPS40FPN1, for OT16...40F3	1SCA105001R1001	83.00
	OTPS80FP, for OT63...OT80F3	1SCA105461R1001	110.00
	OTPS125FP, for OT100...125F3	1SCA105099R1001	172.00
	OTZ250E, for OT160EV...OT250	1SCA022735R9420	220.00
	OTZ400E, for OT315...OT400	1SCA022749R1960	280.00
	OTZ800E, for OT630...OT800	1SCA022807R5100	560.00
	OTZ1250E, for OT1000...OT1250	1SCA103765R1001	1,785.00
	OTZ1600E, for OT1600	1SCA100431R1001	2,181.00
	OTZ2500E, for OT2000...OT2500	1SCA107931R1001	4,326.00
	OTZ4000E, for OT3200...OT4000	1SCA128807R1001	7,000.00
Fuse Replacement Handle 	OFAE506	1SCA128175R1001	242.00
Dual Power Source 	ODPSE230C, for OTM40...2500_	1SCA116892R1001	1,293.00

Fuse Switches

XLP series

Technical Description:

- 1) Type tested according to EN IEC 60947-3
- 2) Integrated IP 20 cable termination
- 3) IP 30 degree of protection from the front



4

3 Poles

Rated Current (A)	Type	Description	Order Code	List Price (RM)
100	000	XLP000-6CC (incl. 6 Cage Clamps)	1SEP201428R0001	333.00
160	00	XLP00-6BC (incl. 6 Bridge Clamps)	1SEP101890R0002	459.00
250	1	XLP1-6BC (incl. 6 Bridge Clamps)	1SEP101891R0002	1,307.00
400	2	XLP2-6BC (incl. 6 Bridge Clamps)	1SEP101892R0002	1,756.00
630	3	XLP3-6BC (incl. 6 Bridge Clamps)	1SEP101975R0002	3,395.00



4 Poles

Rated Current (A)	Type	Description	Order Code	List Price (RM)
160	00	XLP00-4P-8BC (incl. 8 Bridge Clamps)	1SEP600115R0002	919.00
250	1	XLP1-4P-8BC (incl. 8 Bridge Clamps)	1SEP600119R0002	3,354.00
400	2	XLP2-4P-8BC (incl. 8 Bridge Clamps)	1SEP600124R0002	4,670.00
630	3	XLP3-4P-8BC (incl. 8 Bridge Clamps)	1SEP600128R0002	6,274.00



*XLP 1 pole, 2 poles for AC and DC ratings are now available, please consult us for pricing information.

Fuselinks

500V, gG fuse, DIN

Technical Description:

- 1) Complies with EN / IEC 60269-1-2
- 2) DIN type HRC-fuse link range: 2A to 1250A
- 3) AC voltage: 500V AC



Fuse Size	Current Rating (A)	Type	Order Code	List Price (RM)	
000	2A	OFAF000H2	1SCA022627R0230	45.00	
	4A	OFAF000H4	1SCA022627R0310	45.00	
	6A	OFAF000H6	1SCA022627R0400	45.00	
	10A	OFAF000H10	1SCA022627R0580	45.00	
	16A	OFAF000H16	1SCA022627R0660	45.00	
	20A	OFAF000H20	1SCA022627R0740	45.00	
	25A	OFAF000H25	1SCA022627R0820	45.00	
	32A	OFAF000H32	1SCA022627R0910	45.00	
	35A	OFAF000H35	1SCA022627R1040	45.00	
	40A	OFAF000H40	1SCA022627R1120	45.00	
	50A	OFAF000H50	1SCA022627R1210	45.00	
	63A	OFAF000H63	1SCA022627R1390	45.00	
	80A	OFAF000H80	1SCA022627R1470	45.00	
	100A	OFAF000H100	1SCA022627R1550	45.00	
	00	125A	OFAF00H125	1SCA022627R1630	87.00
		160A	OFAF00H160	1SCA022627R1710	87.00
0	200A	OFAF0H200	1SCA022629R5140	91.00	
	224A	OFAF0H224	1SCA022629R5220	91.00	
	250A	OFAF0H250	1SCA022629R5310	91.00	
1	200A	OFAF1H200	1SCA022627R4490	102.00	
	250A	OFAF1H250	1SCA022627R4650	102.00	
2	300A	OFAF2H300	1SCA022627R5970	153.00	
	315A	OFAF2H315	1SCA022627R6010	153.00	
	355A	OFAF2H355	1SCA022627R6190	153.00	
	400A	OFAF2H400	1SCA022627R6270	240.00	
3	500A	OFAF3H500	1SCA022627R7080	260.00	
	630A	OFAF3H630	1SCA022627R7160	260.00	
	800A	OFAF3H800	1SCA022627R7240	446.00	
4	1000A	OFAF4H1000	1SCA022627R7750	1,161.00	
	1250A	OFAF4H1250	1SCA022627R7830	1,295.00	

Enclosed Switch-disconnectors

Side operated Fireman's switches, aluminium enclosed

- Aluminium enclosed & red painted switch-disconnectors
- Enclosure in Aluminum alloy (Silumin) with metric threaded cable entries and special operating handle with loop and interlocking mechanism
- Delivery includes PE terminal and membrane glands (IP54) / sealing plugs

*For IP65 degree of protection compression glands must be used



2 Poles

Rated Current (A) AC22A 230V	Cable sizes Up / Down	Enclosure size (mm)			Type	Order Code	List Price (RM)
		W	H	D			
25	2xM25 / 2xM25	111	130	60	KSF225 DP	2CMA142435R1000	354.00

Side operated Switch-disconnectors, plastic enclosed

- Light grey box with dark grey cover and operating handle
- Enclosure in robust PBT plastic with metric threaded cable entries
- Delivery includes PE terminal and membrane glands (IP54) / sealing plugs



*For IP65 degree of protection compression glands must be used



2 Poles

Rated Current (A) AC22A 230V	Cable sizes Up / Down	Enclosure size (mm)			Type	Order Code	List Price (RM)
		W	H	D			
25	2xM25 / 2xM25	111	130	60	BW225 DP	2CMA142400R1000	256.00

Accessories for Enclosed switches

Category	Description	Order Code	List Price (RM)
Auxiliary Contacts 	OBEA01, 1NC for KSF/BW	1SCA022190R3260	69.00
	OBEA10, 1NO for KSF/BW	1SCA022190R3000	69.00
Adapter for OBEA_ 	OEZNP1, Mountable on top of the switch	1SCA022259R7410	68.00

Type	Auxiliary contacts		Auxiliary contacts / type to add	
	included in standard delivery	maximum	NO	NC
KSF225 DP	–	1NO or 1NC	OBEA10*	OBEA01*
BW225 DP	–	1NO or 1NC	OBEA10*	OBEA01*

*Adapter OEZNP1 needed

A series of horizontal dotted lines for writing.

Capacitor Banks and Controllers



Low Voltage Power Capacitors

CLMD Series

Technical Description:

- Complies with IEC60831-1 & 2:1996
- CLMD range: 2.7kVAR to 130 kVAR
- Voltage range: 220V to 660V ~
- Metal-Clad Casing & Dry type Element
- Non-toxic filler (vermiculite) and Aluminium cooler are used for better heat dissipation
- High Insulation voltage, $U_i=3kV \sim$
- Brass Screws for all live terminals and Earthing terminal
- Internally Protected Elements (IPE) with built-in overcurrent fuses
- All capacitors have built-in discharge resistors



NOTE: Installation of capacitors on networks with harmonics may require special precaution!

Voltage: 440V

Power kvar	Type	Order Code	*MOQ	List Price (RM)
5	CLMD13	2GSB010323A0022	500 kvar	989.00
10	CLMD13	2GSB010146A0022		989.00
15	CLMD13	2GSB010149A0022		1,146.00
20	CLMD33S	2GSB010151A0022		1,528.00
25	CLMD33S	2GSB010154A0022		1,909.00
30	CLMD33S	2GSB010156A0022		2,291.00
20	CLMD43	2GSB010150A0022		1,528.00
25	CLMD43	2GSB010153A0022		1,909.00
30	CLMD43	2GSB010155A0022		1,888.00
35	CLMD53	2GSB010367A0022		2,515.00
40	CLMD53	2GSB010157A0022		2,874.00
45	CLMD53	2GSB010368A0022		3,232.00
50	CLMD53	2GSB010158A0022		3,145.00
60	CLMD63	2GSB010159A0022		4,310.00
65	CLMD63	2GSB010369A0022		4,669.00
70	CLMD63	2GSB010160A0022		5,028.00
75	CLMD63	2GSB010161A0022		5,386.00
80	CLMD63	2GSB010162A0022		5,745.00
85	CLMD63	2GSB010370A0022		6,104.00
90	CLMD83	2GSB010163A0022		6,464.00
100	CLMD83	2GSB010147A0022	7,182.00	

(*) Minimum order quantity must at least 500kvar & above. Mix of 440Vac & 525Vac capacitor bank are allow.

Low Voltage Power Capacitors

CLMD Series



Voltage: 500/525V

Power kvar	Type	Order Code	*MOQ	List Price (RM)
5	CLMD13	2GSB010419A0022	500 kvar	977.00
10	CLMD13	2GSB010176A0022		1,077.00
15	CLMD13	2GSB010180A0022		1,321.00
20	CLMD33S	2GSB010182A0022		1,761.00
25	CLMD33S	2GSB010422A0022		2,200.00
30	CLMD33S	2GSB010186A0022		2,640.00
20	CLMD43	2GSB010183A0022		1,761.00
25	CLMD43	2GSB010184A0022		2,200.00
30	CLMD43	2GSB010187A0022		2,640.00
35	CLMD53	2GSB010188A0022		3,079.00
40	CLMD53	2GSB010450A0022		3,521.00
45	CLMD53	2GSB010469A0022		3,873.00
50	CLMD53	2GSB010453A0022		4,400.00
60	CLMD63	2GSB010454A0022		5,279.00
70	CLMD63	2GSB010455A0022		6,160.00
75	CLMD63	2GSB010423A0022		6,599.00
80	CLMD63	2GSB010174A0022		7,039.00
85	CLMD63	2GSB010424A0022		7,391.00
90	CLMD83	2GSB010425A0022		7,761.00
100	CLMD83	2GSB010177A0022	8,798.00	
120	CLMD83	2GSB010179A0022	10,558.00	

(*) Minimum order quantity must at least 500kvar & above. Mix of 440Vac & 525Vac capacitor bank are allow.

Power Factor Controllers

RVC

- Common range for a broad network voltages from 100V to 440V.
- Measurement and display of key parameters such as voltage, current, power factor, THDV and THDI.
- Fully programmable switching sequence.
- 1A or 5A current input.
- Easy commissioning.
- Complete auto set-up (starting current-C/k, type of switching sequence, phase shift, special connections).
- Overvoltage / undervoltage protection and protections against harmonic distortion (THDV).
- PF setting: from 0.7 inductive to 0.7 capacitive.

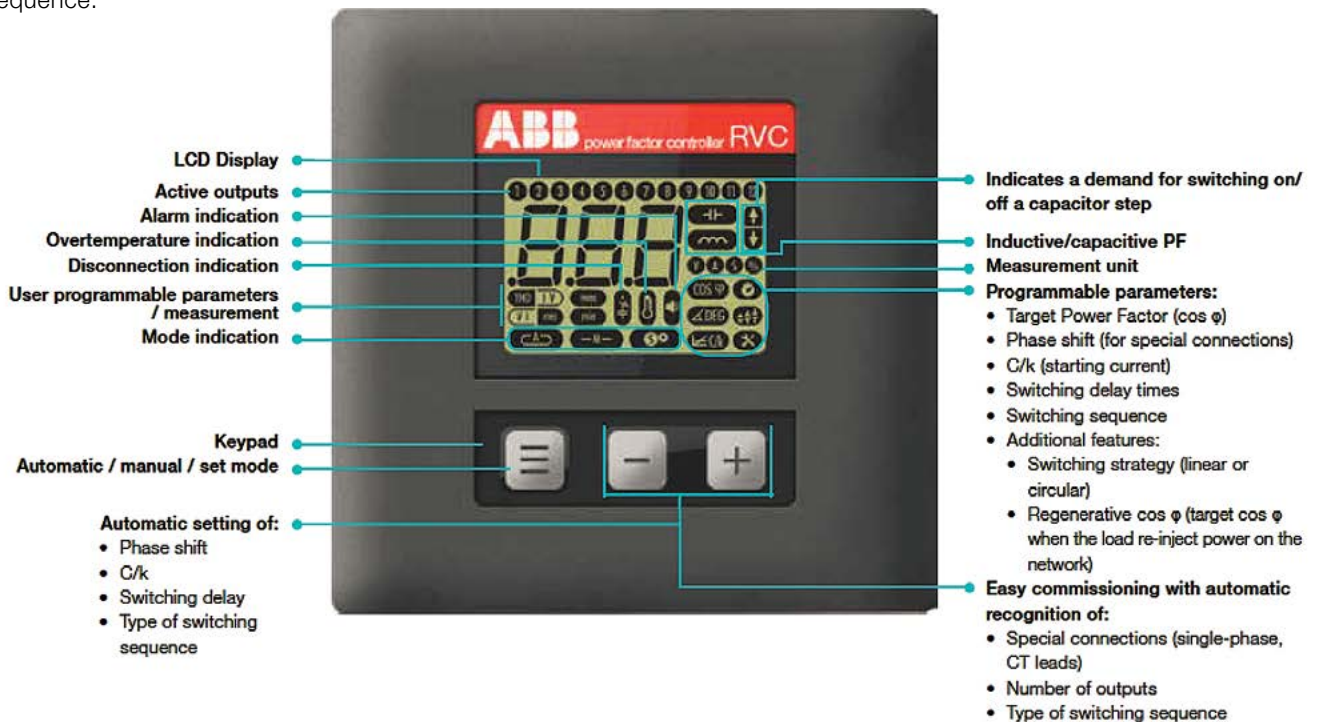

Steps	Type	Order Code	*MOQ	List Price (RM)
3	RVC3	2GCA294983A0050	5 units	3,484.00
6	RVC6	2GCA294984A0050		3,693.00
8	RVC8	2GCA294985A0050		3,819.00
10	RVC10	2GCA294986A0050		3,861.00
12	RVC12	2GCA294987A0050		3,987.00

(*) Minimum order quantity must be at least 5 units & above. Mix of RVC3 to RVC12 are allow.

Power Factor Controllers

RVT

- RVT addresses power factor issues from both single phase loads (L-L or N-N) and three phase balanced/unbalanced loads.
- Common range for all network voltages from 100Vac to 460Vac.
- 3.5 inch colorful QVGA touch screen eases parameter settings.
- Measurement and monitoring:
 - Active power (kW)
 - Apparent power (kVA)
 - Reactive power (kvar)
 - Reactive power (kvar) to reach the target $\cos \phi$
 - Voltage (V)
 - Current (A)
 - $\cos \phi$
 - Total harmonic distortion on Voltage/Current: THD V / I (%)
 - Voltage/Current Harmonics: H2 up to H49 (%-spectrum)
- Communication: modbus (optional).
- PF setting: from 0.7 inductive to 0.7 capacitive.



Steps	Type	Order Code	*MOQ	List Price (RM)
6	RVT6	2GCA291720A0050	2 units	6,946.00
12	RVT12	2GCA291721A0050		8,776.00
12	RVT12-3P	2GCA291722A0050		9,634.00

(*) Minimum order quantity must be at least 2 units & above. Mix of RVT6 to RVC12 are allow.

RVT accessories



External probes for temperature measurements



IP54 Gasket

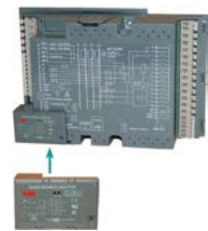

RS485 Modbus adapter kit

Type	Order Code	*MOQ	List Price (RM)
Temperature probe (up to 8 connections with daisy chain)	2GCA291864A0050	Please contact us	3,513.00
IP 54 gasket	2GCA292040A0050		702.00
OPC Server Software	2GCA286141A0050		31,655.00
Kit Modbus Adapter	2GCA291880A0050		4,212.00
PQ LINK Software	2GCA292820A0050		28,941.00

(*) Please contact us for the RVT accessories MOQ.

Low Voltage Power Capacitors

QCap Series

Technical Description:

- Fixing: 1 stud (M12)
- Terminals: Cage screws
- Minimum distance above units: 20mm
- Execution: indoor use only
- Temperature range: -25°C according to IEC60831
- Protection degree: IP20



Voltage	Power kvar	Order Code	*MOQ	List Price (RM)
440V, 50Hz	5.0	2GCA296763A0031	200 pcs	735.00
	6.3	2GCA296768A0031		782.00
	7.5	2GCA296773A0031		678.00
	10.0	2GCA296778A0031		684.00
	12.5	2GCA296783A0031		692.00
	15.0	2GCA296788A0031		699.00
	20.0	2GCA296793A0031		753.00
	25.0	2GCA296796A0031		735.00
525V, 50Hz	30.0	2GCA296799A0031	782.00	
	6.3	2GCA296837A0031	903.00	
	7.5	2GCA296842A0031	722.00	
	10.0	2GCA296847A0031	722.00	
	12.5	2GCA296852A0031	702.00	
	15.0	2GCA296857A0031	722.00	
	20.0	2GCA296862A0031	722.00	
	25.0	2GCA296867A0031	903.00	

(*) Order must be 200pcs in a single lot. Mix of 440Vac & 525Vac capacitor bank are allow.

Benefit

- Discharge resistor: discharge from Un to 50V in 1 minute.
- Max permissible current: 1.3 x In for continuous operation.
- Tolerance on voltage: 30% for maximum 1 min.
- ABB PPMZ (Zinc metalized PP film) guarantees top capacitor quality and long lifespan.

Safety

- Self-healing: metalized dry cap is able to isolate small dielectric breakdown by self healing process.
 - Sealed can: the released gas by self healing will build up pressure in the sealed cylinder.
 - Overpressure disconnector: break all three wires connected to the three elements.
- QCap will be safely disconnected from the load.



Dimensions

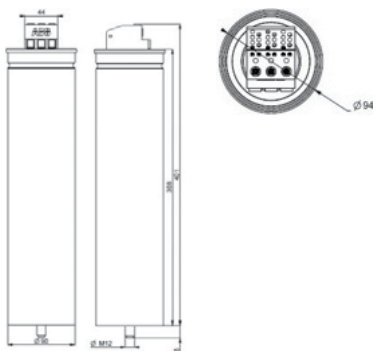

Total H	Can H	D	D fixation screw	H fixation screw
401mm	368mm	90mm	M12	16mm

Contactors



Contactors

AX Range 3-Pole Contactor (AC Operating Voltage)

3 Phase, 400V Motor

AC-3 rating 9A ~ 370A, 4kW ~ 200kW

These contactors are of the block type design with:

- AX09-AX40 with 3 main poles and 1 built-in auxiliary contact
- AX50-AX370 with 3 main poles and mounted auxiliary contact block
- Control circuit: AC operated
- Add-on auxiliary contact blocks for front or side mounting and a wide range of accessories. (Refer to conatctor accessories list)



State coil voltage... (See Table Below)

Power (kW)	AC-3 (A)	AC-1 (A)	Auxiliary Contact		Type	Order Code	List Price (RM)
			N/O	N/C			
4	9	22	1	-	AX09-30-10 . . .	1SBL901074R..10	90.50
4	9	22	-	1	AX09-30-01 . . .	1SBL901074R..01	90.50
5.5	12	25	1	-	AX12-30-10 . . .	1SBL911074R..10	108.70
5.5	12	25	-	1	AX12-30-01 . . .	1SBL911074R..01	108.70
7.5	18	27	1	-	AX18-30-10 . . .	1SBL921074R..10	136.80
7.5	18	27	-	1	AX18-30-01 . . .	1SBL921074R..01	136.80
11	25	32	1	-	AX25-30-10 . . .	1SBL931074R..10	194.70
11	25	32	-	1	AX25-30-01 . . .	1SBL931074R..01	194.70
.....							
15	32	55	1	-	AX32-30-10 . . .	1SBL281074R..10	251.80
15	32	55	-	1	AX32-30-01 . . .	1SBL281074R..01	251.80
18.5	40	60	1	-	AX40-30-10 . . .	1SBL321074R..10	305.30
18.5	40	60	-	1	AX40-30-01 . . .	1SBL321074R..01	305.30
.....							
22	50	100	1	1	AX50-30-11 . . .	1SBL351074R..11	460.40
30	65	115	1	1	AX65-30-11 . . .	1SBL371074R..11	680.60
37	80	125	1	1	AX80-30-11 . . .	1SBL411074R..11	700.60
.....							
45	96	145	1	1	AX95-30-11 . . .	1SFL431074R..11	720.60
55	115	160	1	1	AX115-30-11 . . .	1SFL981074R..11	800.70
75	150	190	1	1	AX150-30-11 . . .	1SFL991074R..11	1,514.30
.....							
90	185	250	1	1	AX185-30-11 . . .	1SFL491074R..11	1,784.50
110	205	275	1	1	AX205-30-11 . . .	1SFL501074R..11	3,594.80
.....							
132	265	400	1	1	AX260-30-11 . . .	1SFL547074R..11	3,607.80
160	305	500	1	1	AX300-30-11 . . .	1SFL587074R..11	3,664.80
200	370	600	1	1	AX370-30-11 . . .	1SFL607074R..11	3,722.90

Note : AX range Contactor do not have UL standard, Contact ABB sales person for more detail

Coil Voltage and codes

Voltage - 50Hz	Voltage - 60Hz	Code...
24	24	81
48	48	83
110	110-120	84
220-230	230-240	80
230-240	240-260	88
380-400	400-415	85
400-415	415-440	86

AF Range 3-Pole Contactor (AC/DC Operating Voltage)

3 Phase, 400V Motor

AC-3 rating 9A ~ 38A, 4kW ~ 18.5kW

- Electronic coil interface with wide AC/DC operating voltage
- Electronic coil interface accepting wide control voltage, U_c
- Built-in surge protection



Power (kW)	AC-3 (A)	AC-1 (A)	Control voltage, U _c		Auxiliary Contact		Type	Order Code	List Price (RM)
			50/60Hz	V DC	N/O	N/C			
4	9	25	24...60	20...60	1	0	AF09-30-10-11	1SBL137001R1110	133.90
			24...60	20...60	0	1	AF09-30-01-11	1SBL137001R1101	133.90
			48...130	48...130	1	0	AF09-30-10-12	1SBL137001R1210	133.90
			48...130	48...130	0	1	AF09-30-01-12	1SBL137001R1201	133.90
4	9	25	100...250	100...250	1	0	AF09-30-10-13	1SBL137001R1310	133.90
			100...250	100...250	0	1	AF09-30-01-13	1SBL137001R1301	133.90
			250...500	250...500	1	0	AF09-30-10-14	1SBL137001R1410	133.90
			250...500	250...500	0	1	AF09-30-01-14	1SBL137001R1401	133.90
5.5	12	28	24...60	20...60	1	0	AF12-30-10-11	1SBL157001R1110	172.90
			24...60	20...60	0	1	AF12-30-01-11	1SBL157001R1101	172.90
			48...130	48...130	1	0	AF12-30-10-12	1SBL157001R1210	172.90
			48...130	48...130	0	1	AF12-30-01-12	1SBL157001R1201	172.90
5.5	12	28	100...250	100...250	1	0	AF12-30-10-13	1SBL157001R1310	172.90
			100...250	100...250	0	1	AF12-30-01-13	1SBL157001R1301	172.90
			250...500	250...500	1	0	AF12-30-10-14	1SBL157001R1410	172.90
			250...500	250...500	0	1	AF12-30-01-14	1SBL157001R1401	172.90
7.5	18	30	24...60	20...60	1	0	AF16-30-10-11	1SBL177001R1110	225.60
			24...60	20...60	0	1	AF16-30-01-11	1SBL177001R1101	225.60
			48...130	48...130	1	0	AF16-30-10-12	1SBL177001R1210	225.60
			48...130	48...130	0	1	AF16-30-01-12	1SBL177001R1201	225.60
7.5	18	30	100...250	100...250	1	0	AF16-30-10-13	1SBL177001R1310	225.60
			100...250	100...250	0	1	AF16-30-01-13	1SBL177001R1301	225.60
			250...500	250...500	1	0	AF16-30-10-14	1SBL177001R1410	225.60
			250...500	250...500	0	1	AF16-30-01-14	1SBL177001R1401	225.60
11	26	45	24...60	20...60	1	1	AF26-30-11-11	1SBL237001R1111	295.10
			48...130	48...130	1	1	AF26-30-11-12	1SBL237001R1211	295.10
			100...250	100...250	1	1	AF26-30-11-13	1SBL237001R1311	295.10
			250...500	250...500	1	1	AF26-30-11-14	1SBL237001R1411	295.10
15	32	50	24...60	20...60	1	1	AF30-30-11-11	1SBL277001R1111	377.20
			48...130	48...130	1	1	AF30-30-11-12	1SBL277001R1211	377.20
			100...250	100...250	1	1	AF30-30-11-13	1SBL277001R1311	377.20
			250...500	250...500	1	1	AF30-30-11-14	1SBL277001R1411	377.20
18.5	38	50	24...60	20...60	1	1	AF38-30-11-11	1SBL297001R1111	493.10
			48...130	48...130	1	1	AF38-30-11-12	1SBL297001R1211	493.10
			100...250	100...250	1	1	AF38-30-11-13	1SBL297001R1311	493.10
			250...500	250...500	1	1	AF38-30-11-14	1SBL297001R1411	493.10

Contactors

AF Range 3-Pole Contactor (AC/DC Operating Voltage)

AF40...AF96 contactors are mainly used for controlling 3-phase motors and power circuit up to 690VAC and 220VDC

- Electronic coil interface with wide AC/DC operating voltage
- Electronic coil interface accepting wide control voltage, U_c
- Built-in surge protection



Rated Power 400V, AC-3 (kW)	AC-3 (A)	AC-1 (A)	Control voltage, U _c		Auxiliary Contact		Type	Order Code	List Price (RM)
			50/60Hz	V DC	N/O	N/C			
18.5	40	70	24...60	20...60	1	1	AF40-30-11-11	1SBL347001R1111	547.80
			48...130	48...130	1	1	AF40-30-11-12	1SBL347001R1211	547.80
			100...250	100...250	1	1	AF40-30-11-13	1SBL347001R1311	547.80
			250...500	250...500	1	1	AF40-30-11-14	1SBL347001R1411	547.80
22	53	100	24...60	20...60	1	1	AF52-30-11-11	1SBL367001R1111	1,048.10
			48...130	48...130	1	1	AF52-30-11-12	1SBL367001R1211	1,048.10
			100...250	100...250	1	1	AF52-30-11-13	1SBL367001R1311	1,048.10
			250...500	250...500	1	1	AF52-30-11-14	1SBL367001R1411	1,048.10
30	65	105	24...60	20...60	1	1	AF65-30-11-11	1SBL387001R1111	1,128.90
			48...130	48...130	1	1	AF65-30-11-12	1SBL387001R1211	1,128.90
			100...250	100...250	1	1	AF65-30-11-13	1SBL387001R1311	1,128.90
			250...500	250...500	1	1	AF65-30-11-14	1SBL387001R1411	1,128.90
37	80	125	24...60	20...60	1	1	AF80-30-11-11	1SBL397001R1111	1,180.40
			48...130	48...130	1	1	AF80-30-11-12	1SBL397001R1211	1,180.40
			100...250	100...250	1	1	AF80-30-11-13	1SBL397001R1311	1,180.40
			250...500	250...500	1	1	AF80-30-11-14	1SBL397001R1411	1,180.40
45	96	130	24...60	20...60	1	1	AF96-30-11-11	1SBL407001R1111	1,870.50
			48...130	48...130	1	1	AF96-30-11-12	1SBL407001R1211	1,870.50
			100...250	100...250	1	1	AF96-30-11-13	1SBL407001R1311	1,870.50
			250...500	250...500	1	1	AF96-30-11-14	1SBL407001R1411	1,870.50

AF Range 3-Pole Contactor (AC/DC Operating Voltage)

AF116...AF140 contactors are mainly used for controlling 3-phase motors and power circuit up to 690VAC
 AF146...AF305 contactors are up to 1000VAC

- Electronic coil interface with wide AC/DC operating voltage
- Electronic coil interface accepting wide control voltage, U_c
- Built-in surge protection

Rated Power 400V, AC-3 (kW)	AC-3 (A)	AC-1 (A)	Control voltage, U _c		Auxiliary Contact		Type	Order Code	List Price (RM)
			50/60Hz	V DC	N/O	N/C			
55	116	160	24...60	20...60	1	1	AF116-30-11-11	1SFL427001R1111	2,215.60
			48...130	48...130	1	1	AF116-30-11-12	1SFL427001R1211	2,215.60
			100...250	100...250	1	1	AF116-30-11-13	1SFL427001R1311	2,215.60
			250...500	250...500	1	1	AF116-30-11-14	1SFL427001R1411	2,215.60
75	146	225	24...60	20...60	1	1	AF146-30-11-11	1SFL467001R1111	3,007.90
			48...130	48...130	1	1	AF146-30-11-12	1SFL467001R1211	3,007.90
			100...250	100...250	1	1	AF146-30-11-13	1SFL467001R1311	3,007.90
			250...500	250...500	1	1	AF146-30-11-14	1SFL467001R1411	3,007.90
90	190	275	24...60	20...60	1	1	AF190-30-11-11	1SFL487002R1111	3,699.10
			48...130	48...130	1	1	AF190-30-11-12	1SFL487002R1211	3,699.10
			100...250	100...250	1	1	AF190-30-11-13	1SFL487002R1311	3,699.10
			250...500	250...500	1	1	AF190-30-11-14	1SFL487002R1411	3,699.10
110	205	350	24...60	20...60	1	1	AF205-30-11-11	1SFL527002R1111	4,674.00
			48...130	48...130	1	1	AF205-30-11-12	1SFL527002R1211	4,674.00
			100...250	100...250	1	1	AF205-30-11-13	1SFL527002R1311	4,674.00
			250...500	250...500	1	1	AF205-30-11-14	1SFL527002R1411	4,674.00
140	265	400	24...60	20...60	1	1	AF265-30-11-11	1SFL547002R1111	5,385.60
			48...130	48...130	1	1	AF265-30-11-12	1SFL547002R1211	5,385.60
			100...250	100...250	1	1	AF265-30-11-13	1SFL547002R1311	5,385.60
			250...500	250...500	1	1	AF265-30-11-14	1SFL547002R1411	5,385.60
160	305	500	24...60	20...60	1	1	AF305-30-11-11	1SFL587002R1111	5,995.10
			48...130	48...130	1	1	AF305-30-11-12	1SFL587002R1211	5,995.10
			100...250	100...250	1	1	AF305-30-11-13	1SFL587002R1311	5,995.10
			250...500	250...500	1	1	AF305-30-11-14	1SFL587002R1411	5,995.10
200	370	600	24...60	20...60	1	1	AF370-30-11-11	1SFL607002R1111	6,421.60
			48...130	48...130	1	1	AF370-30-11-12	1SFL607002R1211	6,421.60
			100...250	100...250	1	1	AF370-30-11-13	1SFL607002R1311	6,421.60
			250...500	250...500	1	1	AF370-30-11-14	1SFL607002R1411	6,421.60

Contactors

AF Range 3-Pole Contactor (AC/DC Operating Voltage)

3 Phase, 400V Motor

AC-3 rating 400A ~ 1050A, 22kW ~ 560kW

- Electronic coil interface with wide AC/DC operating voltage
- AC / DC Operated with Electronic Coil Interface
- Capable to withstand Voltage Interruptions (Voltage Dips) in the Control Supply ($\leq 20\text{ms}$)
- Comply to SEMI F47 Specifications



AF400-30-11

Power (kW)	AC-3 (A)	AC-1 (A)	Control voltage, Uc		Auxiliary Contact		Type	Order Code	List Price (RM)
			50/60Hz	V DC	N/O	N/C			
200	400	600	-	24...60	1	1	AF 400-30-11 . . .	1SFL577001R6811	4,293.30
			48...130	48...130	1	1		1SFL577001R6911	4,293.30
			100...250	100...250	1	1		1SFL577001R7011	4,293.30
			250...500	250...500	1	1		1SFL577001R7111	4,293.30
250	460	700	-	24...60	1	1	AF 460-30-11 . . .	1SFL597001R6811	6,159.70
			48...130	48...130	1	1		1SFL597001R6911	6,159.70
			100...250	100...250	1	1		1SFL597001R7011	6,159.70
			250...500	250...500	1	1		1SFL597001R7111	6,159.70
315	580	800	-	24...60	1	1	AF 580-30-11 . . .	1SFL617001R6811	8,376.40
			48...130	48...130	1	1		1SFL617001R6911	8,376.40
			100...250	100...250	1	1		1SFL617001R7011	8,376.40
			250...500	250...500	1	1		1SFL617001R7111	8,376.40
400	750	1050	-	24...60	1	1	AF 750-30-11 . . .	1SFL637001R6811	14,310.80
			48...130	48...130	1	1		1SFL637001R6911	14,310.80
			100...250	100...250	1	1		1SFL637001R7011	14,310.80
			250...500	250...500	1	1		1SFL637001R7111	14,310.80
475	860	1350	100...250	100...250	1	1	AF 1350-30-11 . . .	1SFL657001R7011	23,681.00
560	1050	1650	100...250	100...250	1	1	AF 1650-30-11 . . .	1SFL677001R7011	60,045.30

Note: ABB A... and AF... Range Contactor also suitable for Capacitor Switching (Single Step - Peak Current ≤ 30 Times the rms current (AC-6b)
Please refer to ABB Contactor Technical Catalogue for selection

Contactors

AF Range 4-Pole Contactor (AC/DC Operating Voltage)

AC-1 rating 25A ~ 55A



IEC AC-1 (A)	UL/CSA 600 V (A)	Control voltage, Uc		Auxiliary Contact		Type	Order Code	List Price (RM)
		50/60Hz	V DC	N/O	N/C			
4 N.O Main Poles								
25	25	24...60	20...60	0	0	AF09-40-00-11	1SBL137201R1100	216.10
		48...130	48...130	0	0	AF09-40-00-12	1SBL137201R1200	216.10
		100...250	100...250	0	0	AF09-40-00-13	1SBL137201R1300	216.10
		250...500	250...500	0	0	AF09-40-00-14	1SBL137201R1400	216.10
30	30	24...60	20...60	0	0	AF16-40-00-11	1SBL177201R1100	316.20
		48...130	48...130	0	0	AF16-40-00-12	1SBL177201R1200	316.20
		100...250	100...250	0	0	AF16-40-00-13	1SBL177201R1300	316.20
		250...500	250...500	0	0	AF16-40-00-14	1SBL177201R1400	316.20
45	45	24...60	20...60	0	0	AF26-40-00-11	1SBL237201R1100	423.70
		48...130	48...130	0	0	AF26-40-00-12	1SBL237201R1200	423.70
		100...250	100...250	0	0	AF26-40-00-13	1SBL237201R1300	423.70
		250...500	250...500	0	0	AF26-40-00-14	1SBL237201R1400	423.70
55	55	24...60	20...60	0	0	AF38-40-00-11	1SBL297201R1100	718.60
		48...130	48...130	0	0	AF38-40-00-12	1SBL297201R1200	718.60
		100...250	100...250	0	0	AF38-40-00-13	1SBL297201R1300	718.60
		250...500	250...500	0	0	AF38-30-00-14	1SBL297201R1400	718.60
2 N.O + 2 N.C Main Poles								
25	25	24...60	20...60	0	0	AF09-22-00-11	1SBL137501R1100	244.60
		48...130	48...130	0	0	AF09-22-00-12	1SBL137501R1200	244.60
		100...250	100...250	0	0	AF09-22-00-13	1SBL137501R1300	244.60
		250...500	250...500	0	0	AF09-22-00-14	1SBL137501R1400	244.60
30	30	24...60	20...60	0	0	AF16-22-00-11	1SBL177501R1100	352.00
		48...130	48...130	0	0	AF16-22-00-12	1SBL177501R1200	352.00
		100...250	100...250	0	0	AF16-22-00-13	1SBL177501R1300	352.00
		250...500	250...500	0	0	AF16-22-00-14	1SBL177501R1400	352.00
45	45	24...60	20...60	0	0	AF26-22-00-11	1SBL237501R1100	459.30
		48...130	48...130	0	0	AF26-22-00-12	1SBL237501R1200	459.30
		100...250	100...250	0	0	AF26-22-00-13	1SBL237501R1300	459.30
		250...500	250...500	0	0	AF26-22-00-14	1SBL237501R1400	459.30
55	55	24...60	20...60	0	0	AF38-22-00-11	1SBL297501R1100	1,069.30
		48...130	48...130	0	0	AF38-22-00-12	1SBL297501R1200	1,069.30
		100...250	100...250	0	0	AF38-22-00-13	1SBL297501R1300	1,069.30
		250...500	250...500	0	0	AF38-22-00-14	1SBL297501R1400	1,069.30

6

Contactors

AF Range 4-Pole Contactor (AC/DC Operating Voltage)

AC-1 rating 70A ~ 125A



IEC AC-1 (A)	UL/CSA 600 V (A)	Control voltage, Uc		Auxiliary Contact		Type	Order Code	List Price (RM)
		50/60Hz	V DC	N/O	N/C			
4 N.O Main Poles								
70	65	–	20...60	0	0	AF45-40-00	1SBL337201R7200	1,770.60
		48...130	48...130	0	0		1SBL337201R6900	1,770.60
		100...250	100...250	0	0		1SBL337201R7000	1,770.60
100	80	–	20...60	0	0	AF50-40-00	1SBL357201R7200	1,643.80
		48...130	48...130	0	0		1SBL357201R6900	1,643.80
		100...250	100...250	0	0		1SBL357201R7000	1,643.80
125	105	–	20...60	0	0	AF75-40-00	1SBL417201R7200	1,850.10
		48...130	48...130	0	0		1SBL417201R6900	1,850.10
		100...250	100...250	0	0		1SBL417201R7000	1,850.10
2 N.O + 2 N.C Main Poles								
70	65	–	20...60	0	0	AF45-22-00	1SBL337501R7200	2,541.30
		48...130	48...130	0	0		1SBL337501R6900	2,541.30
		100...250	100...250	0	0		1SBL337501R7000	2,541.30
125	105	–	20...60	0	0	AF75-22-00	1SBL417501R7200	3,011.00
		48...130	48...130	0	0		1SBL417501R6900	3,011.00
		100...250	100...250	0	0		1SBL417501R7000	3,011.00

Contactors

AF Range 4-Pole Contactor (AC/DC Operating Voltage)

AC-1 rating 160A ~ 525A



IEC AC-1 (A)	UL/CSA 600 V (A)	Control voltage, Uc		Auxiliary Contact		Type	Order Code	List Price (RM)
		50/60Hz	V DC	N/O	N/C			
160	160	24...60	20...60	0	0	AF116-40-00-11	1SFL427101R1100	4,264.80
		48...130	48...130	0	0	AF116-40-00-12	1SFL427101R1200	4,264.80
		100...250	100...250	0	0	AF116-40-00-13	1SFL427101R1300	4,264.80
		250...500	250...500	0	0	AF116-40-00-14	1SFL427101R1400	4,264.80
200	175	24...60	20...60	0	0	AF140-40-00-11	1SFL447101R1100	5,035.60
		48...130	48...130	0	0	AF140-40-00-12	1SFL447101R1200	5,035.60
		100...250	100...250	0	0	AF140-40-00-13	1SFL447101R1300	5,035.60
		250...500	250...500	0	0	AF140-40-00-14	1SFL447101R1400	5,035.60
275	230	24...60	20...60	0	0	AF190-40-00-11	1SFL487102R1100	7,093.90
		48...130	48...130	0	0	AF190-40-00-12	1SFL487102R1200	7,093.90
		100...250	100...250	0	0	AF190-40-00-13	1SFL487102R1300	7,093.90
		250...500	250...500	0	0	AF190-40-00-14	1SFL487102R1400	7,093.90
350	250	24...60	20...60	0	0	AF205-40-00-11	1SFL527102R1100	8,544.00
		48...130	48...130	0	0	AF205-40-00-12	1SFL527102R1200	8,544.00
		100...250	100...250	0	0	AF205-40-00-13	1SFL527102R1300	8,544.00
		250...500	250...500	0	0	AF205-40-00-14	1SFL527102R1400	8,544.00
400	300	24...60	20...60	0	0	AF265-40-00-11	1SFL547102R1100	9,614.00
		48...130	48...130	0	0	AF265-40-00-12	1SFL547102R1200	9,614.00
		100...250	100...250	0	0	AF265-40-00-13	1SFL547102R1300	9,614.00
		250...500	250...500	0	0	AF265-40-00-14	1SFL547102R1400	9,614.00
500	350	24...60	20...60	0	0	AF305-40-00-11	1SFL587102R1100	12,043.70
		48...130	48...130	0	0	AF305-40-00-12	1SFL587102R1200	12,043.70
		100...250	100...250	0	0	AF305-40-00-13	1SFL587102R1300	12,043.70
		250...500	250...500	0	0	AF305-40-00-14	1SFL587102R1400	12,043.70
525	420	24...60	20...60	0	0	AF370-40-00-11	1SFL607102R1100	12,682.70
		48...130	48...130	0	0	AF370-40-00-12	1SFL607102R1200	12,682.70
		100...250	100...250	0	0	AF370-40-00-13	1SFL607102R1300	12,682.70
		250...500	250...500	0	0	AF370-40-00-14	1SFL607102R1400	12,682.70

6

Contactors

EK Range 4 Pole Contactors (AC Operating Voltage)

AC-1 rating 800A ~ 1000A



IEC AC-1 (A)	UL/CSA 600 V (A)	Control voltage, Uc		Auxiliary Contact		Type	Order Code	List Price (RM)
		50Hz	60Hz	N/O	N/C			
800	540	48	–	1	1	EK550-40-11	SK827041-AD	14,585.90
		110	110...120	1	1	EK550-40-11	SK827041-EF	14,585.90
		110...115	115...127	1	1	EK550-40-11	SK827041-EG	14,585.90
		220	220...240	1	1	EK550-40-11	SK827041-EL	14,585.90
		220...230	230...255	1	1	EK550-40-11	SK827041-EM	14,585.90
		380	380...415	1	1	EK550-40-11	SK827041-EP	14,585.90
		380...400	400...440	1	1	EK550-40-11	SK827041-ER	14,585.90
		400...415	–	1	1	EK550-40-11	SK827041-AR	14,585.90
1000	–	48	–	1	1	EK1000-40-11	SK827044-AD	24,950.30
		110	110...120	1	1	EK1000-40-11	SK827044-EF	24,950.30
		110...115	115...127	1	1	EK1000-40-11	SK827044-EG	24,950.30
		220	220...240	1	1	EK1000-40-11	SK827044-EL	24,950.30
		220...230	230...255	1	1	EK1000-40-11	SK827044-EM	24,950.30

UA..RA Range Capacitor Switching Contactors

AC-6b rating 12.5kvar ~ 80kvar at 400Vac rated operation voltage

– Application in which the Peak Current far exceeds 100 times Nominal RMS Current

– High Electrical Durability:

- 250,000 Operating Cycles for $U_e < 500V$
- 100,000 Operating Cycles for $500V \leq U_e \leq 690V$

– Complete with Damping Resistors

– Comply to AC-6b Utilization Category (in accordance to IEC60947-4-1)



State coil voltage... (See Table Below)

Rated Power 400V (kVAr)	Auxiliary Contact		Type	Order Code	List Price (RM)
	N/O	N/C			
12.5	1	–	UA 16-30-10 RA . . .	1SBL181024R..10	443.10
22	1	–	UA 26-30-10 RA . . .	1SBL241024R..10	566.70
30	1	–	UA 30-30-10 RA . . .	1SBL281024R..10	856.90
40	–	–	UA 50-30-00 RA . . .	1SBL351024R..00	916.00
50	–	–	UA 63-30-00 RA . . .	1SBL371024R..00	938.50
60	–	–	UA 75-30-00 RA . . .	1SBL411024R..00	1,033.20
70	–	–	UA 95-30-00 RA . . .	1SFL431024R..00	2,756.20
80	–	–	UA 110-30-00 RA . . .	1SFL451024R..00	2,845.60

Coil Voltage and codes

Voltage - 50Hz	Voltage - 60Hz	Code...
24	24	81
48	48	83
110	110-120	84
220-230	230-240	80
230-240	240-260	88
380-400	400-415	85
400-415	415-440	86

Contactors

UA Range Capacitor Switching Contactors

- AC-6b rating 12.5kvar ~ 75kvar at 400Vac rated operation voltage
- Application in which the Peak Current is Less Than or Equal to 100 times Nominal RMS Current
 - High Electrical Durability (100,000 Operating Cycles)
 - Comply to AC-6b Utilization Category (in accordance to IEC60947-4-1)



State coil voltage... (See Table Below)

Rated Power 400V (kVAr)	Auxiliary Contact		Type	Order Code	List Price (RM)
	N/O	N/C			
12.5	1	–	UA 16-30-10 . . .	1SBL181022R..10	235.60
20	1	–	UA 26-30-10 . . .	1SBL241022R..10	341.90
27.5	1	–	UA 30-30-10 . . .	1SBL281022R..10	500.00
33	1	1	UA 50-30-11 . . .	1SBL351022R..11	537.70
45	1	1	UA 63-30-11 . . .	1SBL371022R..11	681.80
50	1	1	UA 75-30-11 . . .	1SBL411022R..11	767.60
65	1	1	UA 95-30-11 . . .	1SFL431022R..11	1,577.10
75	1	1	UA 110-30-11 . . .	1SFL451022R..11	1,815.70

Coil Voltage and codes

Voltage - 50Hz	Voltage - 60Hz	Code...
24	24	81
48	48	83
110	110-120	84
220-230	230-240	80
230-240	240-260	88
380-400	400-415	85
400-415	415-440	86

Contactors

N/NX... Range Contactor Relays (AC Operated)

– Application in Switching Auxiliary Circuits & Control Circuits



State coil voltage... (See Table Below)

Number of Contacts (4-Pole, 1-Stack)				Type	Order Code	List Price (RM)
1st Stack		2nd Stack				
N/O	N/C	N/O	N/C			
2	2	–	–	NX 22E . . .	1SBH901074R..22	124.90
3	1	–	–	NX 31E . . .	1SBH901074R..31	124.90
4	–	–	–	NX 40E . . .	1SBH901074R..40	124.90

Number of Contacts (8-Pole, 2-Stack)				Type	Order Code	List Price (RM)
1st Stack		2nd Stack				
N/O	N/C	N/O	N/C			
4	–	–	4	N 44E . . .	1SBH141001R..44	228.10
4	–	1	3	N 53E . . .	1SBH141001R..53	228.10
4	–	2	2	N 62E . . .	1SBH141001R..62	228.10
4	–	3	1	N 71E . . .	1SBH141001R..71	228.10
4	–	4	–	N 80E . . .	1SBH141001R..80	228.10

Coil Voltage and codes

Voltage - 50Hz	Voltage - 60Hz	Code...
24	24	81
48	48	83
110	110-120	84
220-230	230-240	80
230-240	240-260	88
380-400	400-415	85
400-415	415-440	86

Contactors

NF... Range Contactor Relays (DC Operated)

- Application in Switching Auxiliary Circuits & Control Circuits
- To replace NL...Range



State coil voltage... (See Table Below)

No. of Contacts (4-Pole, 1-Stack)				Control voltage, Uc		Type	Order Code	List Price (RM)
1st Stack		2nd Stack		50/60Hz	V DC			
N/O	N/C	N/O	N/C					
2	2	-	-	24...60	-	NF22E-41	1SBH137001R4122	261.50
2	2	-	-	48...130	48...130	NF22E-12	1SBH137001R1222	261.50
2	2	-	-	100...250	100...250	NF22E-13	1SBH137001R1322	261.50
2	2	-	-	250...500	250...500	NF22E-14	1SBH137001R1422	261.50
3	1	-	-	24...60	-	NF31E-41	1SBH137001R4131	261.50
3	1	-	-	48...130	48...130	NF31E-12	1SBH137001R1231	261.50
3	1	-	-	100...250	100...250	NF31E-13	1SBH137001R1331	261.50
3	1	-	-	250...500	250...500	NF31E-14	1SBH137001R1431	261.50
4	0	-	-	24...60	-	NF40E-41	1SBH137001R4140	261.50
4	0	-	-	48...130	48...130	NF40E-12	1SBH137001R1240	261.50
4	0	-	-	100...250	100...250	NF40E-13	1SBH137001R1340	261.50
4	0	-	-	250...500	250...500	NF40E-14	1SBH137001R1440	261.50

No. of Contacts (8-Pole, 2-Stack)				Control voltage, Uc		Type	Order Code	List Price (RM)
1st Stack		2nd Stack		50/60Hz	V DC			
N/O	N/C	N/O	N/C					
4	0	0	4	24...60	-	NF44E-41	1SBH137001R4144	342.00
4	0	0	4	48...130	48...130	NF44E-12	1SBH137001R1244	342.00
4	0	0	4	100...250	100...250	NF44E-13	1SBH137001R1344	342.00
4	0	0	4	250...500	250...500	NF44E-14	1SBH137001R1444	342.00
4	0	1	3	24...60	-	NF53E-41	1SBH137001R4153	342.00
4	0	1	3	48...130	48...130	NF53E-12	1SBH137001R1253	342.00
4	0	1	3	100...250	100...250	NF53E-13	1SBH137001R1353	342.00
4	0	1	3	250...500	250...500	NF53E-14	1SBH137001R1453	342.00
4	0	2	2	24...60	-	NF62E-41	1SBH137001R4162	342.00
4	0	2	2	48...130	48...130	NF62E-12	1SBH137001R1262	342.00
4	0	2	2	100...250	100...250	NF62E-13	1SBH137001R1362	342.00
4	0	2	2	250...500	250...500	NF62E-14	1SBH137001R1462	342.00
4	0	3	1	24...60	-	NF71E-41	1SBH137001R4171	342.00
4	0	3	1	48...130	48...130	NF71E-12	1SBH137001R1271	342.00
4	0	3	1	100...250	100...250	NF71E-13	1SBH137001R1371	342.00
4	0	3	1	250...500	250...500	NF71E-14	1SBH137001R1471	342.00
4	0	4	0	24...60	-	NF80E-41	1SBH137001R4180	342.00
4	0	4	0	48...130	48...130	NF80E-12	1SBH137001R1280	342.00
4	0	4	0	100...250	100...250	NF80E-13	1SBH137001R1380	342.00
4	0	4	0	250...500	250...500	NF80E-14	1SBH137001R1480	342.00

Contactors Accessories

Front Mounting Auxiliary Contact



For Contactor:	Type	Auxiliary Contact		Order Code	List Price (RM)
		N/O	N/C		
Contactor Front Mounting Auxiliary Contact Blocks (1-Pole)					
AX09 ~ AX150	CA5X-10	1	-	1SBN019010R1010	19.00
NX (4-pole)	CA5X-01	-	1	1SBN019010R1001	19.00
AF09 ~ AF96	CA4-10	1	-	1SBN010110R1010	23.30
NF (4-pole)	CA4-01	-	1	1SBN010110R1001	23.30

6



Contactor Front Mounting Auxiliary Contact Blocks (4-Pole)					
AX09~AX40-30-10	CA5X-22M	2	2	1SBN019040R1122	94.80
	CA5X-04M	-	4	1SBN019040R1104	94.80
AX09...AX40-30-01	CA5X-22U	2	2	1SBN019040R1322	94.80
	CA5X-40U	4	-	1SBN019040R1340	94.80
AX50...AX150	CA5X-22E	2	2	1SBN019040R1022	94.80
	CA5X-40E	4	-	1SBN019040R1040	94.80
	CA5X-04E	-	4	1SBN019040R1004	94.80
AF09~AF16-30-10	CA4-22M	2	2	1SBN010140R1122	94.80
	CA4-04M	-	4	1SBN010140R1104	94.80
AF09~AF16-30-01	CA4-22U	2	2	1SBN010140R1322	94.80
	CA4-40U	4	-	1SBN010140R1340	94.80
AF26~AF96-30-00 AF09~AF80 (4-Pole)	CA4-22E	2	2	1SBN010140R1022	94.80
	CA4-40E	4	-	1SBN010140R1040	94.80
	CA4-04E	-	4	1SBN010140R1004	94.80

Contactors Accessories

Side Mounting Auxiliary Contact



For Contactor:	Type	Auxiliary Contact		Order Code	List Price (RM)
		N/O	N/C		
Contactor 2-Pole Side Mounting Auxiliary Contact					
AX09~AX80 and NX	CAL5X-11	1	1	1SBN019020R1011	47.50
AX95~AX205	CAL18X-11	1	1	1SFN019820R1011	80.10
AX185~AX205	CAL18X-11B	1	1	1SFN019820R3311	80.10
AF09~AF96 and NF	CAL4-11	1	1	1SBN010120R1011	52.80
AF116~AF370	CAL19-11	1	1	1SFN010820R1011	80.10
AX260~AX370	CAL19-11B			1SFN010820R3311	80.10
AF400~AF2650 UA95, UA110	CAL 18-11	1	1	1SFN010720R1011	80.10
AF400~AF2650	CAL 18-11B	1	1	1SFN010720R3311	80.10
EK Range Contactors Side Mounting Auxiliary Contact					
All EK Contactor	CAL 16-11 A	1	1	SK 829 002-A	91.80
	CAL 16-11 B	1	1	SK 829 002-B	91.80
	CAL 16-11 C	1	1	SK 829 002-C	91.80
	CAL 16-11 D	1	1	SK 829 002-D	91.80

Contactors Accessories

ABB Timer



TE5S



TEF4 electronic timer

TE5S Electronic Timer for Star-Delta Starters

For Contactor:	Rated Control Voltage, Uc (V)	Type	Order Code	List Price (RM)
AX09 ~ AX205	24 AC/DC	TE5S-24	1SBN020010R1001	410.90
	110 ~ 120 AC	TE5S-120	1SBN020010R1002	410.90
	220 ~ 240 AC	TE5S-240	1SBN020010R1003	410.90
	380 ~ 440 AC	TE5S-440	1SBN020010R1004	601.70

6

TEF Electronic Timer for contactors and contactor relays

- Built-in surge protection
- 3 setting time ranges

For Contactor:	Time Delay Setting	Delay Type	Supply Voltage	Auxillary Contacts	Type	Order Code	List Price (RM)
AF09 ~ AF96 & NF	0.1...1 s 1...10 s	ON-delay	24 - 240V	1NO / 1NC	TEF4 - ON	1SBN020112R1000	348.40
		OFF-delay	AC/DC		TEF4 - OFF	1SBN020114R1000	348.40
AX09 ~ AX80 & NX	10...100 s	ON-delay	24 - 240V		TEF5 - ON	1SBN020312R1000	348.40
		OFF-delay	AC/DC		TEF5 - OFF	1SBN020314R1000	348.40

Contactors Accessories

Mechanical Interlock Units

Mechanical & Electrical Interlock Units



VM4

Mechanical Interlock Units for Two Horizontal Mounted Contactors

Left side	Right side	Type	Order Code	List Price (RM)
AX9 ~ AX40	AX9 ~ AX40	VM 5-1	1SBN030100R1000	108.60
AX95 ~ AX205	AX185 ~ AX205	VM 300H	1SFN034700R1000	189.70
AX260 ~ AX370	AX260 ~ AX370	VM 19	1SFN030300R1000	195.20
AF09 ~ AF38	AF09 ~ AF38	*VM 4	1SBN030105T1000	47.50
AF116 ~ AF370	AF116 ~ AF370	VM 19	1SFN030300R1000	195.20
AF400 ~ AF1250	AF400 ~ AF1250	VM 750H	1SFN035700R1000	416.20

* With MOQ 10 PCs



VE 5-1

VEM4

Mechanical Interlock Units for Two Horizontal Mounted Contactors

Left side	Right side	Type	Order Code	List Price (RM)
AX09 ~ AX40	AX9 ~ AX40	VE 5-1	1SBN030110R1000	84.40
AX32 ~ AX80	AX50 ~ AX80	VE 5-2	1SBN030210R1000	113.90
AF09 ~ AF38	AF09 ~ AF38	VEM4	1SBN030111R1000	108.60
EK110, EK150	EK110, EK150	VH 145	SK 829 071-A	204.40
EK175, EK210	EK175, EK210	VH 300	SK 829 071-B	271.90

Connecting Links for Contactor & Manual Motor Starter



Connecting Links

For Contactor:	For MMS	Type	Order Code	List Price (RM)
AX09 ~ AX18	MS116-0.16 ... MS116-16 / MS132-0.16 ... MS132-10	*BEA 16/116	1SBN081406R1000	54.80
AX25	MS116-0.16 ... MS116-16 / MS132-0.16 ... MS132-10	*BEA 25/116	1SBN089306T1000	64.30
AX25	MS116-20 ... MS116-32 / MS132-12 ... MS132-32	*BEA 25/132	1SBN089306T1001	64.30
AX32 ~ AX40	MS 450	BEA 40/450	1SBN083206R1000	128.60
AX50	MS 450	BEA 50/450	1SBN083506R1000	147.60
AX50 ~ AX85	MS 495	BEA 75/495	1SBN084106R1000	245.60
AX95 ~ AX150	MS 495	BEA 110/495	1SBN084506R1000	418.30
AF09 ~ AF16	MS116-0.16 ~ MS116-25 MS132-0.16 ~ MS132-25	*BEA 16-4	1SBN081306T1000	48.50
AF26 ~ AF38	MS116-0.16 ~ MS116-16 MS132-0.16 ~ MS132-10	*BEA 26-4	1SBN082306T1000	48.50
AF26 ~ AF38	MS116-20 ~ MS116-32 MS132-12 ~ MS132-32	*BEA 38-4	1SBN082306T2000	48.50

* With MOQ 10 PCs

Contactors Accessories

Contactors Coils

AC/DC Operated Coils for AF400 ~ AF2050 Contactors



ZAF 300

For Contactor:	Control voltage, Uc		Type	Order Code	List Price (RM)
	50/60Hz	V DC			
AF400, AF460	–	24...60	ZAF 460	1SFN155770R6806	2,153.30
	48...130	48...130		1SFN155770R6906	
	100...250	100...250		1SFN155770R7006	
	250...500	250...500		1SFN155770R7106	
AF580, AF1250	–	24...60	ZAF 750	1SFN156170R6806	2,512.50
	48...130	48...130		1SFN156170R6906	
	100...250	100...250		1SFN156170R7006	
	250...500	250...500		1SFN156170R7106	
AF580, AF1250	100...250	100...250	ZAF 1650 . . .(1)	1SFN156570R7026	790.20
			ZP 1650 . . .(2)	1SFN166521R1070	8,252.60

(1) Compulsory to purchase 1 set of 2 coils

(2) Printed circuit board

Mini Contactor



Mini Contactor

Coil Voltage for mini contactor:

B6, B7, VB6, VB7, BC6, BC7, VBC6, VBC7, K6, KC6

VAC (1) 40-450Hz	Code Number	VDC	Code Number
24	0...1	12	0...7
42	0...2	24	0...1
48	0...3	42	0...2
110...127	8...4	48	1...6
220...240	8...0	60	0...3
380...415	8...5	110...125 220...240	0...4 0...5

(1) Coil voltage range: 0.85...1,1 x U_c



Mini Contactors – B 6 Range

Mini Contactors with Screw Connection, for AC Operation, 3.5VA

Motor Output, kW (AC-2 & AC-3)		Auxiliary Switches		Type	Order Code	List Price (RM)
220V 240V	380V 440V	N/O	N/C			
2.2	4.0	1	0	B 6-30-10	GJL1211001R.10.	136.80
2.2	4.0	0	1	B 6-30-01	GJL1211001R.01.	136.80
2.2	4.0	0	0	B 6-40-00	GJL1211201R.00.	136.80

Mini Contactors – BC 6 Range

Mini Contactors with Screw Connection, for DC Operation, 3.5W

Motor Output, kW (AC-2 & AC-3)		Auxiliary Switches		Type	Order Code	List Price (RM)
220V 240V	380V 440V	N/O	N/C			
2.2	4.0	1	0	BC6-30-10	GJL1213001R.10.	136.80
2.2	4.0	0	1	BC6-30-01	GJL1213001R.01.	136.80



Mini Contactors – B 7 Range

Mini Contactors with Screw Connection, for AC Operation, 3.5VA

Motor Output, kW (AC-2 & AC-3)		Auxiliary Switches		Type	Order Code	List Price (RM)
220V 240V	380V 440V	N/O	N/C			
3.0	5.5	1	0	B 7-30-10	GJL1311001R.10.	151.50
3.0	5.5	0	1	B 7-30-01	GJL1311001R.01.	151.50
3.0	5.5	0	0	B 7-40-00	GJL1311201R.00.	151.50

Mini Contactors – BC 7 Range

Mini Contactors with Screw Connection, for DC Operation, 3.5W

Motor Output, kW (AC-2 & AC-3)		Auxiliary Switches		Type	Order Code	List Price (RM)
220V 240V	380V 440V	N/O	N/C			
3.0	5.5	1	0	BC7-30-10	GJL1313001R.10.	151.50
3.0	5.5	0	1	BC7-30-01	GJL1313001R.01.	151.50

Mini Contactor

Compact Reversing Contactors with Mechanical Interlock – VB 6 Range

Reversing Contactors with Screw Connection, for AC Operation, 3.5VA



Motor Output, kW (AC-2 & AC-3)		Auxiliary Switches		Type	Order Code	List Price (RM)
220V 240V	380V 440V	N/O	N/C			
2.2	4.0	1	0	VB6-30-10	GJL1211901R.10.	279.80
2.2	4.0	0	1	VB6-30-01	GJL1211901R.01.	279.80

7

Compact Reversing Contactors with Mechanical Interlock – VBC 6 Range

Reversing Contactors with Screw Connection, for DC Operation, 3.5W

Motor Output, kW (AC-2 & AC-3)		Auxiliary Switches		Type	Order Code	List Price (RM)
220V 240V	380V 440V	N/O	N/C			
2.2	4.0	1	0	VBC6-30-10	GJL1213901R.10.	279.80
2.2	4.0	0	1	VBC6-30-01	GJL1213901R.01.	279.80



Compact Reversing Contactors with Mechanical Interlock – VB 7 Range

Reversing Contactors with Screw Connection, for AC Operation, 3.5VA

Motor Output, kW (AC-2 & AC-3)		Auxiliary Switches		Type	Order Code	List Price (RM)
220V 240V	380V 440V	N/O	N/C			
3.0	5.5	1	0	VB7-30-10	GJL1311901R.10.	330.30
3.0	5.5	0	1	VB7-30-01	GJL1311901R.01.	330.30

Mini Contactors – VBC 7 Range

Mini Contactors with Screw Connection, for DC Operation, 3.5W

Motor Output, kW (AC-2 & AC-3)		Auxiliary Switches		Type	Order Code	List Price (RM)
220V 240V	380V 440V	N/O	N/C			
3.0	5.5	1	0	VBC7-30-10	GJL1313901R.10.	330.30
3.0	5.5	0	1	VBC7-30-01	GJL1313901R.01.	330.30

Mini Contactor

Interface Motor Contactors – BC 6 Range

Motor Contactors with Screw Connection, for DC Operation, 24V / 1.4W



Motor Output, kW (AC-2 & AC-3)		Auxiliary Switches		Type	Order Code	List Price (RM)
220V 240V	380V 440V	N/O	N/C			
2.2	4.0	1	0	BC6-30-10-1.4	GJL1213001R8101	154.60
2.2	4.0	0	1	BC6-30-01-1.4	GJL1213001R8011	154.60

Motor Contactors with Screw Connection, for DC Operation, 17V-32V / 2.4W

Motor Output, kW (AC-2 & AC-3)		Auxiliary Switches		Type	Order Code	List Price (RM)
220V 240V	380V 440V	N/O	N/C			
2.2	4.0	1	0	BC6-30-10-2.4	GJL1213001R5101	154.60
2.2	4.0	0	1	BC6-30-01-2.4	GJL1213001R5011	154.60



Interface Motor Contactors – BC 7 Range

Motor Contactors with Screw Connection, for DC Operation, 24V / 1.4W

Motor Output, kW (AC-2 & AC-3)		Auxiliary Switches		Type	Order Code	List Price (RM)
220V 240V	380V 440V	N/O	N/C			
3.0	5.5	1	0	BC7-30-10-1.4	GJL1313001R8101	162.00
3.0	5.5	0	1	BC7-30-01-1.4	GJL1313001R8011	162.00

Motor Contactors with Screw Connection, for DC Operation, 17V-32V / 2.4W

Motor Output, kW (AC-2 & AC-3)		Auxiliary Switches		Type	Order Code	List Price (RM)
220V 240V	380V 440V	N/O	N/C			
3.0	5.5	1	0	BC7-30-10-2.4	GJL1313001R5101	162.00
3.0	5.5	0	1	BC7-30-01-2.4	GJL1313001R5011	162.00

Mini Contactor

Mini Contactor Relays – K 6 Range

Contactor Relays with Screw Connection for AC Operation, 3.5VA



AC-15 Utilization Category (A)			Auxiliary Switches		Type	Order Code	List Price (RM)
220V 240V	380V 440V	500V	N/O	N/C			
4.0	3.0	2.0	4	0	K 6-40 E	GJH1211001R.40.	133.60
4.0	3.0	2.0	3	1	K 6-31 Z	GJH1211001R.31.	133.60
4.0	3.0	2.0	2	2	K 6-22 Z	GJH1211001R.22.	133.60

Mini Contactor Relays – KC 6 Range

Contactor Relays with Screw Connection for DC Operation, 3.5W

AC-15 Utilization Category (A)			Auxiliary Switches		Type	Order Code	List Price (RM)
220V 240V	380V 440V	500V	N/O	N/C			
4.0	3.0	2.0	4	0	KC 6-40 E	GJH1213001R.40.	133.60
4.0	3.0	2.0	3	1	KC 6-31 Z	GJH1213001R.31.	133.60
4.0	3.0	2.0	2	2	KC 6-22 Z	GJH1213001R.22.	133.60



Mini Contactor Relays for Railway Application (Extended Coil Operating Range)

Mini Contactor Relays TKC 6 with Screw Connection for DC Operation

AC-1 240V max (A)	Motor Output, kW (AC-2 & AC-3)			Auxiliary Switches		Type	Order Code	List Price (RM)
	220V 240V	380V 440V	500V	N/O	N/C			
6	–	–	–	2	2	TKC 6-22Z	GJH1213061R.22.	197.80
6	–	–	–	2	2	TKC 6-31Z	GJH1213061R.31.	197.80
6	–	–	–	4	0	TKC 6-40E	GJH1213061R.40.	197.80

Mini Contactor

Coil Voltage for mini contactor:
TBC7, TKC6

VDC	Code Number
17...32	5...1
50...90	5...5
77...143	6...2
140...260	6...8



Mini Motor Contactors for Railway Application (Extended Coil Operating Range)

Mini Motor Contactors TBC 7 with Screw Connection for DC Operation

AC-1 240V max (A)	Motor Output, kW (AC-2 & AC-3)			Auxiliary Switches		Type	Order Code	List Price (RM)
	220V 240V	380V 440V	500V	N/O	N/C			
20	3.0	5.5	4.0	1	0	TBC 7-30-10	GJL1313061R.10.	197.80
20	3.0	5.5	4.0	0	1	TBC 7-30-01	GJL1313061R.01.	197.80

Mini Contactor Accessories

Auxiliary Switch Blocks for Mounting at one Side⁽¹⁾



For Mini Contactor	Type	Order Code	List Price (RM)
K6 and KC 6	CA 6-11K	GJL1201317R0001	63.90
B6(7)-40-00 and BC6(7)-40-00	CA 6-11E	GJL1201317R0002	63.90
B6(7)-30-10 and BC6(7)-30-10	CA 6-11M	GJL1201317R0003	63.90
B6(7)-30-01 and BC6(7)-30-01	CA 6-11N	GJL1201317R0004	63.90



Auxiliary Switch Blocks for Mounting at Front(1) Screw Connection

For Mini Contactor	Type	Order Code	List Price (RM)
K6 and KC 6	CAF 6-11K	GJL1201330R0001	63.90
K6 and KC 6	CAF 6-20K	GJL1201330R0005	63.90
K6 and KC 6	CAF 6-02K	GJL1201330R0009	63.90
B(C)6-, B(C)7-40-00, VB(C)...(A)	CAF 6-11E	GJL1201330R0002	63.90
B(C)6-, B(C)7-40-00, VB(C)...(A)	CAF 6-20E	GJL1201330R0006	63.90
B(C)6-, B(C)7-40-00, VB(C)...(A)	CAF 6-02E	GJL1201330R0010	63.90
B(C)6-, B(C)7-30-10, VB(C)...(A)	CAF 6-11M	GJL1201330R0003	63.90
B(C)6-, B(C)7-30-10, VB(C)...(A)	CAF 6-20M	GJL1201330R0007	63.90
B(C)6-, B(C)7-30-10, VB(C)...(A)	CAF 6-02M	GJL1201330R0011	63.90
B(C)6-, B(C)7-30-01, VB(C)...(A)	CAF 6-11N	GJL1201330R0004	63.90
B(C)6-, B(C)7-30-01, VB(C)...(A)	CAF 6-20N	GJL1201330R0008	63.90
B(C)6-, B(C)7-30-01, VB(C)...(A)	CAF 6-02N	GJL1201330R0012	63.90

(1) Auxiliary Switches CA 6 and CAF 6 may not be fitted simultaneously

Reversing Connecting Link

For Mini Contactor	Type	Order Code	List Price (RM)
VB, VBC with Screw Connection	BSM 6-30	GJL1201908R0001	53.60

Parallel Connecting Link

For Mini Contactor	Type	Order Code	List Price (RM)
B, BC, with Screw Connection	LP 6	GJL1201907R0001	16.60

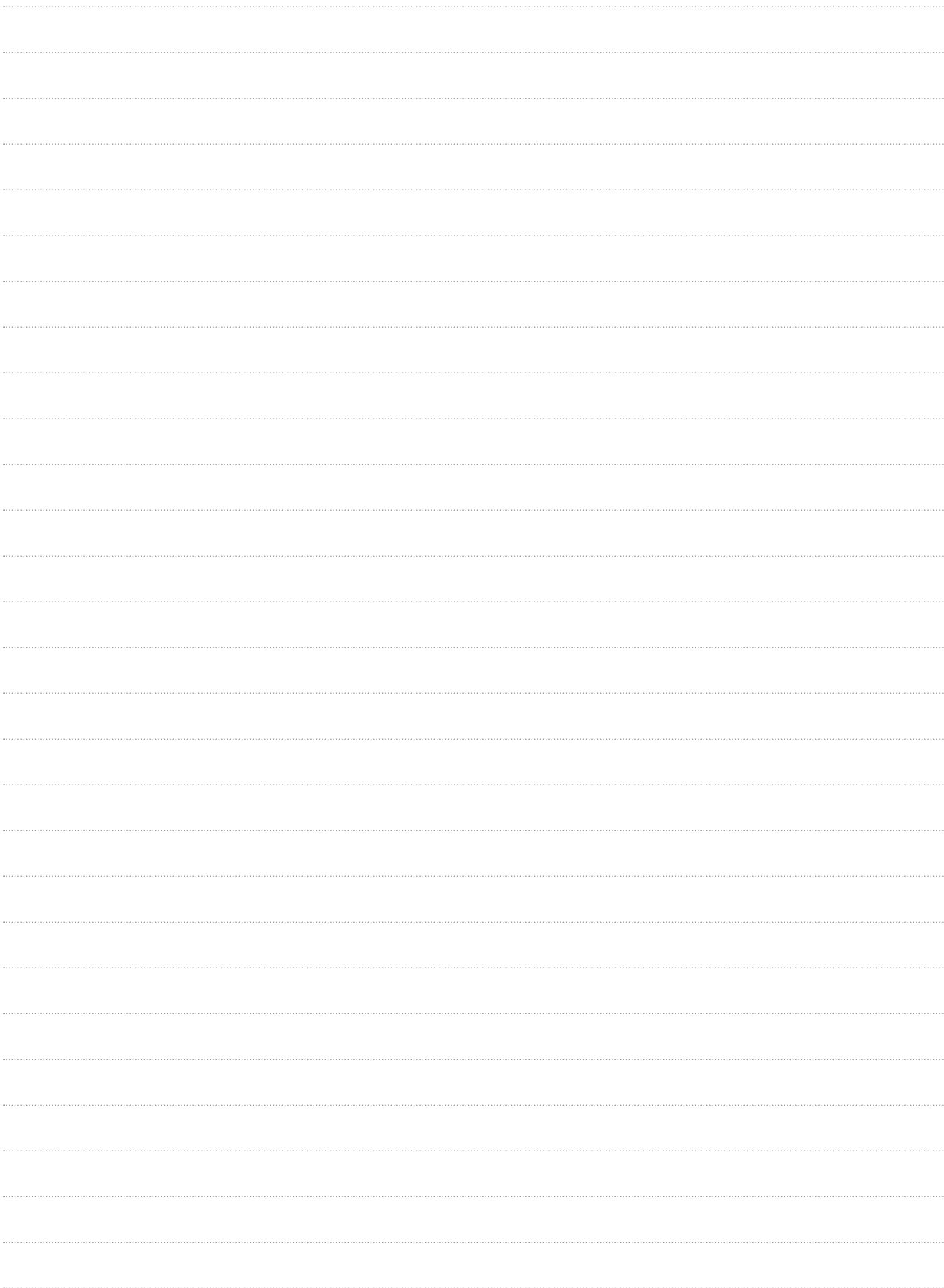

Installation Contactors (ESB)



A series of 25 horizontal dotted lines spanning the width of the page, providing a template for handwriting practice.

Installation Contactors (ESB)

ESB20...ESB63

- ESB range includes 4 ratings from 20A up to 63A
 - For controlling and remote switching
 - Low-noise switching
 - Hum-free solenoid drive
 - Switching position indicator
 - Integrated coil protective circuit
 - Attachable auxiliary switch
 - Overvoltage protection for the solenoid coil up to 5kV
 - High making/breaking capacity and long service life
 - Quick fastening with latching slide
 - Large connections with open box terminals
- AC Operated:
- 230V / 240V 50Hz



Power (kW)	Rating AC-3 (A)	AC-1 (A)	Main Poles	Type	Coil Voltage	Order Code	List Price (RM)
4	9	20	2 N.O	ESB 20-20	230V	GHE3211102R0006	122.90
					240V	GHE3211102R0005	122.90
			2 N.C	ESB 20-02	230V	GHE3211202R0006	122.90
					240V	GHE3211202R0005	122.90
			1 N.O	ESB 20-11	230V	GHE3211302R0006	122.90
					1 N.C	240V	GHE3211302R0005

AC/DC Operated:

- Wide Range Coil Voltage 230V...240V 50Hz

Power (kW)	Rating AC-3 (A)	AC-1 (A)	Main Poles	Type	Order Code	List Price (RM)
5.3	9	24	4 N.O	ESB 24-40	GHE3291102R0006	156.20
					4 N.C	ESB 24-04
			2 N.O	ESB 24-22	GHE3291302R0006	156.20
					2 N.C	
			3 N.O	ESB 24-31	GHE3291602R0006	156.20
					1 N.C	
1 N.O	ESB 24-13	GHE3291702R0006	156.20			
3 N.C						

ESB20...ESB63

AC/DC Operated:

- Wide Range Coil Voltage 230V...240V 50Hz

Power (kW)	Rating AC-3 (A)	AC-1 (A)	Main Poles	Type	Order Code	List Price (RM)
8.8	22	40	4 N.O	ESB 40-40	GHE3491102R0006	314.30

AC/DC Operated:

- Wide Range Coil Voltage 230V...240V 50Hz

Power (kW)	Rating AC-3 (A)	AC-1 (A)	Main Poles	Type	Order Code	List Price (RM)
13.8	30	63	4 N.O	ESB 63-40	GHE3691102R0006	407.40

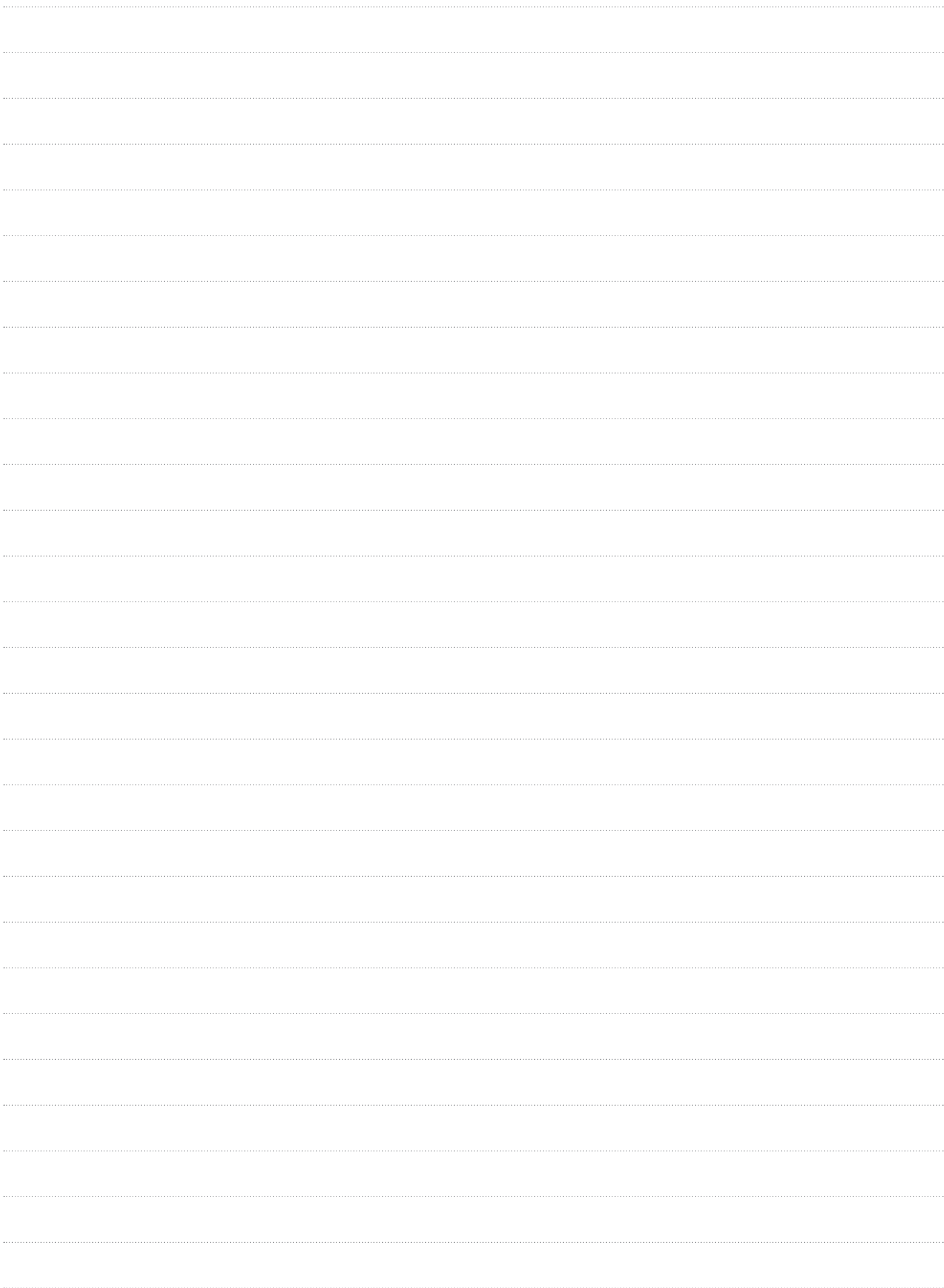

Thermal Overload Relays (TOR) & Electronic Overload Relays (EOLR)



Power and productivity
for a better world™



Thermal Overload Relays (TOR)

T 16DU Range

- For Mini Contactors Range:
- Trip Class 10



For Contactor	Setting Range (A)		Type	Order Code	List Price (RM)
	Minimum	Maximum			
B6, BC6, VB6, VBC6, B7,BC7, VB7, VBC7	0.10	0.13	T16-0.13	1SAZ711201R1005	129.10
	0.13	0.17	T16-0.17	1SAZ711201R1008	129.10
	0.17	0.23	T16-0.23	1SAZ711201R1009	129.10
	0.23	0.31	T16-0.31	1SAZ711201R1013	129.10
	0.31	0.41	T16-0.41	1SAZ711201R1014	129.10
	0.41	0.55	T16-0.55	1SAZ711201R1017	129.10
	0.55	0.74	T16-0.74	1SAZ711201R1021	129.10
	0.74	1.00	T16-1.0	1SAZ711201R1023	129.10
	1.00	1.30	T16-1.3	1SAZ711201R1025	129.10
	1.30	1.70	T16-1.7	1SAZ711201R1028	129.10
	1.70	2.30	T16-2.3	1SAZ711201R1031	129.10
	2.30	3.10	T16-3.1	1SAZ711201R1033	129.10
	3.10	4.20	T16-4.2	1SAZ711201R1035	129.10
	4.20	5.70	T16-5.7	1SAZ711201R1038	129.10
	5.70	7.60	T16-7.6	1SAZ711201R1040	129.10
	7.60	10.0	T16-10.0	1SAZ711201R1043	129.10
	10.0	13.0	T16-13.0	1SAZ711201R1045	129.10
	13.0	16.0	T16-16.0	1SAZ711201R1047	139.80

Thermal Overload Relays (TOR)

TA25 DU...M

- For AX range Contactors:
- Trip Class 10A



For Contactor	Setting Range (A)		Type	Order Code	List Price (RM)
	Minimum	Maximum			
AX 09 ~ AX 40	0.1	0.16	TA 25 DU 0.16 M	1SAZ211201R2005	114.80
	0.16	0.25	TA 25 DU 0.25 M	1SAZ211201R2009	114.80
	0.25	0.4	TA 25 DU 0.4 M	1SAZ211201R2013	114.80
	0.4	0.63	TA 25 DU 0.63 M	1SAZ211201R2017	114.80
	0.63	1.0	TA 25 DU 1.0 M	1SAZ211201R2021	114.80
	1.0	1.4	TA 25 DU 1.4 M	1SAZ211201R2023	114.80
	1.3	1.8	TA 25 DU 1.8 M	1SAZ211201R2025	114.80
	1.7	2.4	TA 25 DU 2.4 M	1SAZ211201R2028	114.80
	2.2	3.1	TA 25 DU 3.1 M	1SAZ211201R2031	114.80
	2.8	4.0	TA 25 DU 4.0 M	1SAZ211201R2033	114.80
	3.5	5.0	TA 25 DU 5.0 M	1SAZ211201R2035	114.80
	4.5	6.5	TA 25 DU 6.5 M	1SAZ211201R2038	114.80
	6	8.5	TA 25 DU 8.5 M	1SAZ211201R2040	114.80
	7.5	11	TA 25 DU 11 M	1SAZ211201R2043	114.80
	10	14	TA 25 DU 14 M	1SAZ211201R2045	114.80
	13	19	TA 25 DU 19 M	1SAZ211201R2047	140.20
	18	25	TA 25 DU 25 M	1SAZ211201R2051	151.80
	24	32 ⁽¹⁾	TA 25 DU 32 M	1SAZ211201R2053	183.50

For TA25DU M range that do not have UL standard, kindly contact ABB salesperson for more details

Note: (1) With terminal block DX25: 1 x 16mm²

Thermal Overload Relays (TOR)

TA42DU...M

- For AX range Contactors:
- Trip Class 10A



For Contactor	Setting Range (A)		Type	Order Code	List Price (RM)
	Minimum	Maximum			
AX30, AX40	18	25	TA 42 DU 25 M	1SAZ311201R2001	198.20
	22	32	TA 42 DU 32 M	1SAZ311201R2002	223.50
	29	42	TA 42 DU 42 M	1SAZ311201R2003	226.60

For TA42DU...M range do not have UL standard, Contact ABB sales person for more detail

TA75DU...M

- For AX range Contactors:
- Trip Class 10A



For Contactor	Setting Range (A)		Type	Order Code	List Price (RM)
	Minimum	Maximum			
AX50 ~ AX80	18	25	TA 75 DU 25 M	1SAZ321201R2001	323.60
	22	32	TA 75 DU 32 M	1SAZ321201R2002	323.60
	29	42	TA 75 DU 42 M	1SAZ321201R2003	323.60
	36	52	TA 75 DU 52 M	1SAZ321201R2004	416.20
	45	63	TA 75 DU 63 M	1SAZ321201R2005	416.20
	60	80	TA 75 DU 80 M	1SAZ321201R2006	416.20

For TA75DU...M range do not have UL standard, Contact ABB sales person for more detail

TA80DU

- For AX range Contactors:
- Trip Class 10A



For Contactor	Setting Range (A)		Type	Order Code	List Price (RM)
	Minimum	Maximum			
AX95, AX150	29	42	TA 80 DU 42	1SAZ331201R1003	366.70
	36	52	TA 80 DU 52	1SAZ331201R1004	476.40
	45	63	TA 80 DU 63	1SAZ331201R1005	476.40
	60	80	TA 80 DU 80	1SAZ331201R1006	494.60

Thermal Overload Relays (TOR)

TA110DU

- For AX range Contactors:
- Trip Class 10A



For Contactor	Setting Range (A)		Type	Order Code	List Price (RM)
	Minimum	Maximum			
AX95, AX150	65	90	TA 110 DU 90	1SAZ411201R1001	531.20
	80	110	TA 110 DU 110	1SAZ411201R1002	586.10

TA 200 DU

- For AX/AF range Contactors:
- Trip Class 10A



For Contactor	Setting Range (A)		Type	Order Code	List Price (RM)
	Minimum	Maximum			
	66	90	TA 200 DU 90	1SAZ421201R1001	985.80
	80	110	TA 200 DU 110	1SAZ421201R1002	985.80
AX150...AX205 (1)	100	135	TA 200 DU 135	1SAZ421201R1003	985.80
	110	150	TA 200 DU 150	1SAZ421201R1004	985.80
AF190 & AF205	130	175	TA 200 DU 175	1SAZ421201R1005	985.80
	150	200	TA 200 DU 200	1SAZ421201R1006	985.80

Note: (1) The max. AC-3 operational current is 182A for AX205 with TA200DU-200.

Thermal Overload Relays (TOR)

TF42

- For AF range Contactors:
- Trip Class 10



For Contactor	Setting Range (A)		Type	Order Code	List Price (RM)
	Minimum	Maximum			
AF09...AF38	0.10	0.13	TF42-0.13	1SAZ721201R1005	154.90
	0.13	0.17	TF42-0.17	1SAZ721201R1008	154.90
	0.17	0.23	TF42-0.23	1SAZ721201R1009	154.90
	0.23	0.31	TF42-0.31	1SAZ721201R1013	154.90
	0.31	0.41	TF42-0.41	1SAZ721201R1014	154.90
	0.41	0.55	TF42-0.55	1SAZ721201R1017	154.90
	0.55	0.74	TF42-0.74	1SAZ721201R1021	154.90
	0.74	1.00	TF42-1.0	1SAZ721201R1023	154.90
	1.00	1.30	TF42-1.3	1SAZ721201R1025	154.90
	1.30	1.70	TF42-1.7	1SAZ721201R1028	154.90
	1.70	2.30	TF42-2.3	1SAZ721201R1031	154.90
	2.30	3.10	TF42-3.1	1SAZ721201R1033	154.90
	3.10	4.20	TF42-4.2	1SAZ721201R1035	154.90
	4.20	5.70	TF42-5.7	1SAZ721201R1038	154.90
	5.70	7.60	TF42-7.6	1SAZ721201R1040	154.90
	7.60	10.0	TF42-10.0	1SAZ721201R1043	154.90
	10.0	13.0	TF42-13.0	1SAZ721201R1045	176.40
	13.0	16.0	TF42-16.0	1SAZ721201R1047	176.40
	16.0	20.0	TF42-20.0	1SAZ721201R1049	176.40
	20.0	24.0	TF42-24.0	1SAZ721201R1051	216.30
	24.0	29.0	TF42-29.0	1SAZ721201R1052	252.70
	29.0	35.0	TF42-35.0	1SAZ721201R1053	264.50
	35.0	38.0	TF42-38.0	1SAZ721201R1055	264.50

Thermal Overload Relays (TOR) Accessories

Mounting Kits for Single Set-Ups

Mounting Kits for Thermal Overload Relay Single Set-Up and Mounting Thermal Overload Relays onto Contactors



For Thermal Overload Relay (T.O.R.)	Type	Order Code	List Price (RM)
TA 25 DU 25 A	DB 25/25 A	1SAZ201108R0001	96.00
TA 25 DU 32 A	DB 25/32 A	1SAZ201108R0002	131.80
TA 42 DU			
TA 75 DU	DB 80	1SAZ301110R0001	229.70
TA 80 DU			
TA 110 DU			
TA 200 DU	DB 200	1SAZ401110R0001	229.70

Note: Relays TA 25 DU to TA 200 DU can be mounted onto Contactors without Mounting Kits

Electronic Overload Relays (EOLR)

E 16 DU – E 1250 DU Range

–Selectable Tripping Class (Class 10, 20 & 30)



For Contactor	Setting Range (A)		Type	Order Code	List Price (RM)
	Minimum	Maximum			
	0.1	0.32	E16DU-0.32	1SAX111001R1101	714.90
AX09...AX18,	0.3	1	E16DU-1.0	1SAX111001R1102	714.90
B6, BC6,	0.9	2.7	E16DU-2.7	1SAX111001R1103	714.90
B7, BC7	2	6.3	E16DU-6.3	1SAX111001R1104	788.00
	5.7	18.9	E16DU-18.9	1SAX111001R1105	788.00
	0.1	0.32	EF19-0.32	1SAX121001R1101	604.30
	0.3	1	EF19-1.0	1SAX121001R1102	604.30
AF9...AF38	0.8	2.7	EF19-2.7	1SAX121001R1103	604.30
	1.9	6.3	EF19-6.3	1SAX121001R1104	678.40
	5.7	18.9	EF19-18.9	1SAX121001R1105	678.40
AX32...AX40,	9	30	EF45-30	1SAX221001R1101	1,062.20
AF26...AF38	15	45	EF45-45	1SAX221001R1102	1,319.10
AF40...AF65	25	70	EF65-70	1SAX331001R1101	1,648.00
AF80, AF96	36	100	EF96-100	1SAX341001R1101	1,743.10
AF116...AF146	54	150	EF146-150	1SAX351001R1101	2,246.70
AX185...AX205, AF190, AF205	63	210	EF205-210	1SAX531001R1101	2,526.20
AX260...AX370, AF265...AF370	115	380	EF370-380	1SAX611001R1101	2,856.10
AF400, AF460	150	500	EF460-500	1SAX721001R1101	3,478.60
AF580, AF750	250	800	EF750-800	1SAX821001R1101	6,223.90
AF1350, AF1650	375	1250	E1250DU-1250	1SFA739001R1000	9,145.60

Electronic Overload Relays (EOLR) Accessories

E 16 DU Range Accessories

Mounting Kit for Single Set-Ups on Rail or Plate



for EOLR	Type	Order Code	List Price (RM)
E 16 DU	DB 16 E	1SAX101110R0001	117.00

E 200 DU ~ E 1250 DU Range Accessories

Mounting Kits for AF Contactors (include busbars and accessories for contactor mounting)

Mounting Kit for Contactors	Type	Order Code	List Price (RM)
AF 400/460	DT 500/AF 460S	1SAX701902R1011	2,081.60
AF 400/460 (Reversing)	DT 500/AF 460L	1SAX701902R1001	2,040.50
AF 580/750	DT 800/AF 750S	1SAX801902R1011	2,040.50
AF 580/750 (Reversing)	DT 800/AF 750L	1SAX801902R1001	2,142.80

A series of horizontal dotted lines for writing.

Manual Motor Starter



Manual Motor Starter

Manual Motor Starter (Motor Circuit Breaker) with Thermal-Magnetic Protection

- MS116 Range with Short-Circuit Breaking Capacity up to 50kA
- Trip Class 10A



Setting Range (A)		Type	Order Code	List Price (RM)
Minimum	Maximum			
0.10	0.16	MS116 - 0.16	1SAM250000R1001	193.40
0.16	0.25	MS116 - 0.25	1SAM250000R1002	193.40
0.25	0.40	MS116 - 0.40	1SAM250000R1003	193.40
0.40	0.63	MS116 - 0.63	1SAM250000R1004	193.40
0.63	1.00	MS116 - 1.00	1SAM250000R1005	193.40
1.00	1.60	MS116 - 1.60	1SAM250000R1006	193.40
1.60	2.50	MS116 - 2.50	1SAM250000R1007	193.40
2.50	4.00	MS116 - 4.00	1SAM250000R1008	193.40
4.00	6.30	MS116 - 6.30	1SAM250000R1009	193.40
6.30	10.00	MS116 - 10.00	1SAM250000R1010	193.40
8.00	12.00	MS116 - 12.00	1SAM250000R1012	233.50
10.00	16.00	MS116 - 16.00	1SAM250000R1011	233.50
16.00	20.00	MS116 - 20.00	1SAM250000R1013	291.10
20.00	25.00	MS116 - 25.00	1SAM250000R1014	310.60
25.00	32.00	MS116 - 32.00	1SAM250000R1015	387.70

Manual Motor Starter (Motor Circuit Breaker) with Thermal-Magnetic Protection

- MS132 Range with Short-Circuit Breaking Capacity up to 100kA
- Trip Class 10



Setting Range (A)		Type	Order Code	List Price (RM)
Minimum	Maximum			
0.10	0.16	MS132 - 0.16	1SAM350000R1001	288.90
0.16	0.25	MS132 - 0.25	1SAM350000R1002	288.90
0.25	0.40	MS132 - 0.4	1SAM350000R1003	288.90
0.40	0.63	MS132 - 0.63	1SAM350000R1004	288.90
0.63	1.00	MS132 - 1.0	1SAM350000R1005	315.00
1.00	1.60	MS132 - 1.6	1SAM350000R1006	315.00
1.60	2.50	MS132 - 2.5	1SAM350000R1007	315.00
2.50	4.00	MS132 - 4.0	1SAM350000R1008	315.00
4.00	6.30	MS132 - 6.3	1SAM350000R1009	315.00
6.30	10.00	MS132 - 10.0	1SAM350000R1010	388.60
8.00	12.00	MS132 - 12.0	1SAM350000R1012	388.60
10.00	16.00	MS132 - 16.0	1SAM350000R1011	388.60
16.00	20.00	MS132 - 20.00	1SAM350000R1013	444.00
20.00	25.00	MS132 - 25.00	1SAM350000R1014	499.40
25.00	32.00	MS132 - 32.00	1SAM350000R1015	666.50

Manual Motor Starter

Manual Motor Starter (Motor Circuit Breaker) with Thermal-Magnetic Protection

- MS165 Range with Short-Circuit Breaking Capacity up to 50kA
- Trip Class 10



Minimum	Setting Range (A)		Type	Order Code	List Price (RM)
	Minimum	Maximum			
10		16	MS165-16	1SAM451000R1011	830.90
14		20	MS165-20	1SAM451000R1012	898.90
18		25	MS165-25	1SAM451000R1013	991.20
23		32	MS165-32	1SAM451000R1014	1,083.50
30		42	MS165-42	1SAM451000R1015	1,156.40
40		54	MS165-54	1SAM451000R1016	1,341.00
52		65	MS165-65	1SAM451000R1017	1,467.30

10

Manual Motor Starter (Motor Circuit Breaker) with Thermal-Magnetic Protection

- MS495 Range with Short-Circuit Breaking Capacity up to 50kA
- Trip Class 10



Minimum	Setting Range (A)		Type	Order Code	List Price (RM)
	Minimum	Maximum			
57		75	MS495-75	1SAM550000R1008	1,848.60
70		90	MS495-90	1SAM550000R1009	1,960.50
80		100 ⁽¹⁾	MS495-100	1SAM550000R1010	2,218.90

(1) Maximum Motor Current is 95A

Manual Motor Starter Accessories

MS116,MS132 and MS165 Range Accessories: Auxiliary Contact, Signaling Contact & Auxiliary Trip Units

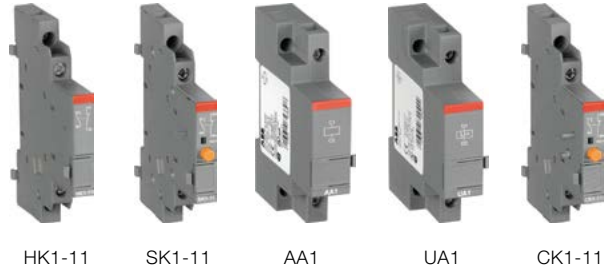

Function	Mounting	Features	Type	Order Code	List Price (RM)
Auxiliary Switches	Front	1 N/O + 1 N/C	HKF1-11	1SAM201901R1001	50.10
Auxiliary Switches	Lateral (Right)	1 N/O + 1 N/C	HK1-11	1SAM201902R1001	37.30
Auxiliary Switches	Lateral (Right)	2 N/O	HK1-20	1SAM201902R1002	37.30
Auxiliary Switches	Lateral (Right)	2 N/C	HK1-02	1SAM201902R1003	37.30
Shunt Release	Lateral (Left)	24V, 50/60Hz	AA1-24	1SAM201910R1001	221.30
Shunt Release	Lateral (Left)	110V, 50/60Hz	AA1-110	1SAM201910R1002	221.30
Shunt Release	Lateral (Left)	200-240V, 50/60Hz	AA1-230	1SAM201910R1003	221.30
Shunt Release	Lateral (Left)	350-415V, 50/60Hz	AA1-400	1SAM201910R1004	221.30
Signal/Trip Contact	Lateral (Right)	1 N/O + 1 N/C	SK1-11	1SAM201903R1001	43.80
Signal/Trip Contact	Lateral (Right)	2 N/O	SK1-20	1SAM201903R1002	94.80
Signal/Trip Contact	Lateral (Right)	2 N/C	SK1-02	1SAM201903R1003	94.80
Undervoltage Release	Lateral (Left)	24V, 50Hz	UA1-24	1SAM201904R1001	334.10
Undervoltage Release	Lateral (Left)	48V, 50Hz	UA1-48	1SAM201904R1002	334.10
Undervoltage Release	Lateral (Left)	60V, 50Hz	UA1-60	1SAM201904R1003	334.10
Undervoltage Release	Lateral (Left)	110V,50Hz/120V,60Hz	UA1-120	1SAM201904R1004	334.10
Undervoltage Release	Lateral (Left)	208V, 60Hz	UA1-208	1SAM201904R1008	334.10
Undervoltage Release	Lateral (Left)	230V,50Hz/240V,60Hz	UA1-230	1SAM201904R1005	334.10
Undervoltage Release	Lateral (Left)	400V, 50Hz	UA1-400	1SAM201904R1006	334.10
Undervoltage Release	Lateral (Left)	415V,50Hz/480V,60Hz	UA1-415	1SAM201904R1007	334.10
Locking Device *	-	Lock Adapter	SA1	GJF1101903R0001	79.80
Locking Device *	-	Padlock + 2 Keys	SA2	GJF1101903R0002	155.40
Locking Device *	-		SA3	GJF1101903R0003	178.60

* Only for MS116

MS116,MS132 and MS165 Range Accessories: Short-Circuit Alarm

Function	Mounting	Features	Type	Order Code	List Price (RM)
Short-Circuit Alarm	Lateral (Right)	1 N/O + 1 N/C	CK1-11	1SAM301901R1001	91.60
Short-Circuit Alarm	Lateral (Right)	2 N/O	CK1-20	1SAM301901R1002	91.60
Short-Circuit Alarm	Lateral (Right)	2 N/C	CK1-02	1SAM301901R1003	91.60

Manual Motor Starter Accessories

MS116 & MS132 Range Accessories: Shaft



Shaft Length (mm)	Type	Order Code	List Price (RM)
130	OXS6X130	1SCA101655R1001	40.00
180	OXS6X180	1SCA101659R1001	45.00

Note: A complete set of rotary handle consist of Shaft, Selector Handle & Driver.



MS116 & MS132 Range Accessories: Selector Handles IP64

Manual Motor Starter		Color	Type	Order Code	List Price (RM)
MS116	MS132				
X		Black/Red	MSHD-LB ⁽¹⁾	1SAM201920R1001	124.60
X		Yellow/Red	MSHD-LY ⁽¹⁾	1SAM201920R1002	124.60
	X	Black/Red	MSHD-LTB ⁽²⁾	1SAM201920R1011	138.30
	X	Yellow/Red	MSHD-LTY ⁽²⁾	1SAM201920R1012	138.30

(1) Indication I-O and ON-OFF

(2) Indication I-O-T and ON-OFF-T

Note: A complete set of rotary handle consist of Shaft, Selector Handle & Driver.

10



MS116 & MS132 Range Accessories: Driver

Coupling driver for use with 6mm OXS6...type up to 180mm

Type	Order Code	List Price (RM)
MSMN	1SAM101923R0002	12.90

Note: A complete set of rotary handle consist of Shaft, Selector Handle & Driver.

Manual Motor Starter Accessories

MS165 Range Accessories: Auxiliary Contact, Signaling Contact & Auxiliary Trip Units

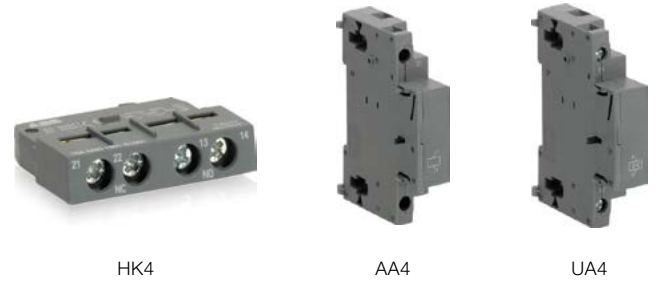

Function	Mounting	Features	Type	Order Code	List Price (RM)
Auxiliary Switches	Front	1 N/O + 1 N/C	HK4-11	1SAM401901R1001	123.50
Auxiliary Switches	Front	1 Changeover	HK4-W	1SAM401901R1002	123.50
Auxiliary Switches	Lateral (Left)	1 N/O + 1 N/C	HKS4-11	1SAM401902R1001	123.50
Auxiliary Switches	Lateral (Left)	2 N/O	HKS4-20	1SAM401902R1002	123.50
Auxiliary Switches	Lateral (Left)	2 N/C	HKS4-02	1SAM401902R1003	123.50
Signal/Trip Contact *	Lateral (Left)	1 N/O + 1 N/C	SK4-11	1SAM401904R1001	210.70
Undervoltage Release	Lateral (Right)	24V 50Hz	UA4	1SAM401905R1004	268.20
Undervoltage Release	Lateral (Right)	110V 50Hz	UA4	1SAM401905R1001	268.20
Undervoltage Release	Lateral (Right)	230V 50Hz/240V 60Hz	UA4	1SAM401905R1002	268.20
Undervoltage Release	Lateral (Right)	400V 50Hz	UA4	1SAM401905R1003	268.20
Shunt Release	Lateral (Left)	20-70V, 50/60Hz/DC	AA4	1SAM401907R1001	268.20
Shunt Release	Lateral (Left)	70-190V, 50/60Hz/DC	AA4	1SAM401907R1002	268.20
Shunt Release	Lateral (Left)	190-330V, 50/60Hz/DC	AA4	1SAM401907R1003	268.20
Shunt Release	Lateral (Left)	330-500V, 50/60Hz/DC	AA4	1SAM401907R1004	268.20

* Pilot Switch according to UL 508 Type E Application, for separate signalling of Short-Circuit and General Tripping, Lateral Mounting, left side. Maximum 1 piece, also together with Auxiliary Switch

Pilot Devices



Pilot Devices – Modular Range

Contact Block Combinations

- Alt. 1
- Operator
 - + Holder
 - + Contact Block(s)

- Alt. 2
- Operator
 - + Holder with Contact Block(s)

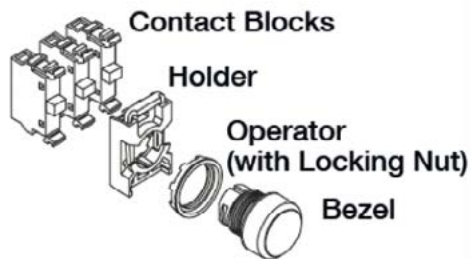

Pushbuttons

Mushroom Pushbuttons

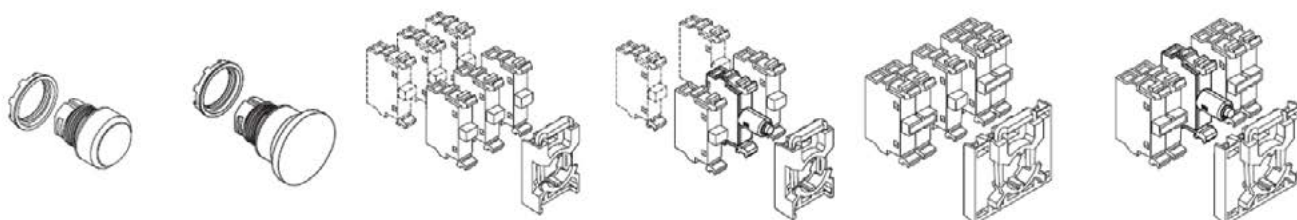

Double Pushbuttons

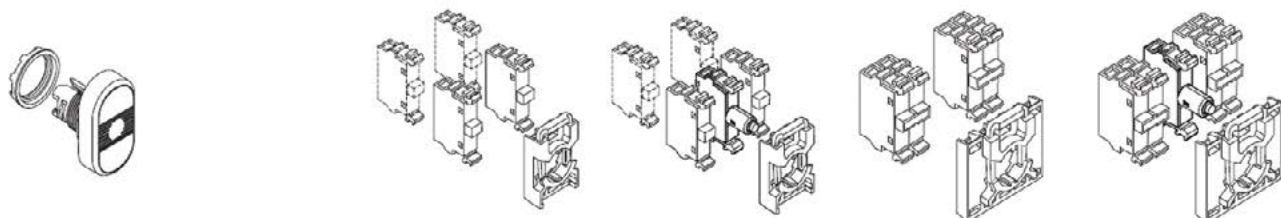

Emergency Stop Pushbuttons

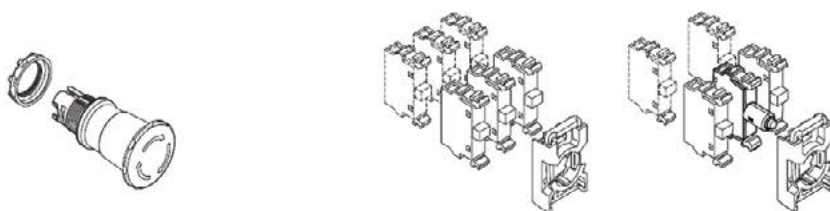

Pilot Devices – Modular Range

Selector Switches

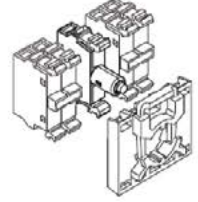
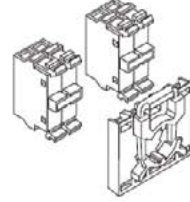
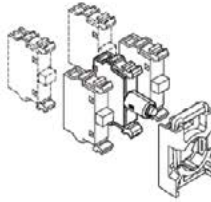
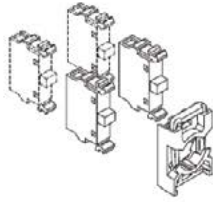

Key-operated Selector Switches

Toggle Switches

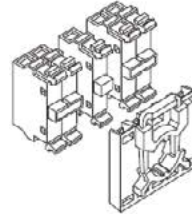
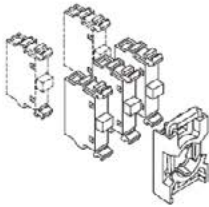

Pilot Lights

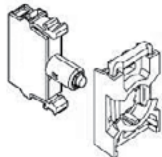

Pilot Devices – Modular Type

Push Button – Non-illuminated

- with 1 Aux contact
- Flush mounted
- Momentary
- Minimum Order Quantity: 10 pcs



Color	NO	NC	Head Order Code	Price	Body Order Code	Price	Complete Unit Price (RM)
Red	0	1	MP1-10R 1SFA611100R1001	14.60	MCBH-01 1SFA611605R1110	17.90	32.50
Green	1	0	MP1-10G 1SFA611100R1002	14.60	MCBH-10 1SFA611605R1101	17.90	32.50
Yellow	1	0	MP1-10Y 1SFA611100R1003	14.60	MCBH-10 1SFA611605R1101	17.90	32.50
Blue	1	0	MP1-10L 1SFA611100R1004	14.60	MCBH-10 1SFA611605R1101	17.90	32.50
White	1	0	MP1-10W 1SFA611100R1005	14.60	MCBH-10 1SFA611605R1101	17.90	32.50
Black	1	0	MP1-10B 1SFA611100R1006	14.60	MCBH-10 1SFA611605R1101	17.90	32.50
Clear	1	0	MP1-10C 1SFA611100R1008	14.60	MCBH-10 1SFA611605R1101	17.90	32.50

Mushroom Pushbuttons

- with 1 Aux contact
- Non-illuminated
- Pull release

Diameter: 40mm



Color	NO	NC	Head Order Code	Price	Body Order Code	Price	Complete Unit Price (RM)
Red	0	1	MPM1-10R 1SFA611124R1001	57.20	MCBH-01 1SFA611605R1110	17.90	75.10

Pilot Devices – Modular Type

Emergency Stop Push Button

- with 1 Aux contact
- Non-illuminated
- Fulfill IEC 60947-5-5
- Twist release



Diameter: 40mm

Color	NO	NC	Head Order Code	Price	Body Order Code	Price	Complete Unit Price (RM)
Red	0	1	MPMT3-10R 1SFA611510R1001	69.50	MCBH-01 1SFA611605R1110	17.90	87.40
Red	0	1	MPET4-10R 1SFA611523R1001	69.50	MCBH-01 1SFA611605R1110	17.90	87.40

Diameter: 30mm

Color	NO	NC	Head Order Code	Price	Body Order Code	Price	Complete Unit Price (RM)
Red	0	1	MPET3-10R 1SFA611520R1001	69.50	MCBH-01 1SFA611605R1110	17.90	87.40

Diameter: 40mm, with key (key code: 71)

Color	NO	NC	Head Order Code	Price	Body Order Code	Price	Complete Unit Price (RM)
Red	0	1	MPEK4-11R 1SFA611525R1101	135.10	MCBH-01 1SFA611605R1110	17.90	153.00

Diameter: 30mm, with key (key code: 71)

Color	NO	NC	Head Order Code	Price	Body Order Code	Price	Complete Unit Price (RM)
Red	0	1	MPEK3-11R 1SFA611522R1101	135.10	MCBH-01 1SFA611605R1110	17.90	153.00



Pilot Devices – Modular Type

Two-Position Selector Switches

- Non-illuminated
- Short Handle
- Maintained



Color	NO	NC	Head Order Code	Price	Body Order Code	Price	Complete Unit Price (RM)
Black	0	1	M2SS2-10B 1SFA611201R1006	27.50	MCBH-01 1SFA611605R1110	17.90	45.40
Black	1	1	M2SS2-10B 1SFA611201R1006	27.50	MCBH-11 1SFA611605R1111	34.70	62.20

Three-Position Selector Switches

- Non-illuminated
- Short Handle
- Maintained

Color	NO	NC	Head Order Code	Price	Body Order Code	Price	Complete Unit Price (RM)
-------	----	----	-----------------	-------	-----------------	-------	--------------------------

Three Position: Maintained

	Black	2	0	M3SS1-10B 1SFA611210R1006	27.50	MCBH-20 1SFA611605R1102	34.70	62.20
--	-------	---	---	------------------------------	-------	----------------------------	-------	-------

Momentary, spring return from A to B and from C to B

	Black	2	0	M3SS2-10B 1SFA611211R1006	33.70	MCBH-20 1SFA611605R1102	34.70	68.40
--	-------	---	---	------------------------------	-------	----------------------------	-------	-------

Pilot Devices – Modular Type

Key-Operated Selector Switches

– Key Code: 71 / Ronis: 455



	Key Position	NO	NC	Head Order Code	Price	Body Order Code	Price	Complete Unit Price (RM)
Two Position: Maintained								
	Position B only	2	0	M2SSK2-101 1SFA611281R1001	78.60	MCBH-20 1SFA611605R1102	34.70	113.30
	Both	2	0	M2SSK1-101 1SFA611280R1001	78.60	MCBH-20 1SFA611605R1102	34.70	113.30
Two Position : Momentary								
	Position B only	2	0	M2SSK3-101 1SFA611282R1001	84.80	MCBH-20 1SFA611605R1102	34.70	119.50
Three Position: Maintained								
	Position B only	3	0	M3SSK2-101 1SFA611284R1001	109.20	MCBH-30 1SFA611605R1103	52.00	161.20
	Both	3	0	M3SSK1-101 1SFA611283R1001	109.20	MCBH-30 1SFA611605R1103	52.00	161.20

Pilot Devices – Modular Type

Toggle Switches



	NO	NC	Head Order Code	Price	Body Order Code	Price	Complete Unit Price (RM)
Two Position: Maintained							
	1	0	MTS1-10B 1SFA 611 300 R 1006	64.30	MCBH-10 1SFA 611 60 5R1101	17.90	82.20
Three Position: Maintained							
	2	0	MTS3-10B 1SFA 611 302 R1006	68.40	MCBH-20 1SFA 611 60 5R1102	34.70	103.10
Three Position: Momentary, spring return from A to B and from C to B							
	2	0	MTS2-10B 1SFA 611 301 R1006	68.40	MCBH-20 1SFA 611 60 5R1102	34.70	103.10

Pilot Devices – Modular Type

Push Button – Illuminated

- with 2 Aux contact
- Flush mounted
- Momentary
- Minimum Order Quantity: 10 pcs



Color	NO	NC	Head Order Code	Price	LED Order Code	Price	Contact Order Code	Price	Complete Unit Price (RM)
Rated voltage 24 V, AC/DC									
Red	1	1	MP1-11R 1SFA611100R1101	55.10	MLBL-01R 1SFA611621R1011	26.60	MCBH-11 1SFA611605R1111	34.70	116.40
Green	1	1	MP1-11G 1SFA611100R1102	55.10	MLBL-01G 1SFA611621R1012	26.60	MCBH-11 1SFA611605R1111	34.70	116.40
Yellow	1	1	MP1-11Y 1SFA611100R1103	55.10	MLBL-01Y 1SFA611621R1013	26.60	MCBH-11 1SFA611605R1111	34.70	116.40
Blue	1	1	MP1-11L 1SFA611100R1104	55.10	MLBL-01L 1SFA611621R1014	26.60	MCBH-11 1SFA611605R1111	34.70	116.40
White	1	1	MP1-11W 1SFA611100R1105	55.10	MLBL-01W 1SFA611621R1015	26.60	MCBH-11 1SFA611605R1111	34.70	116.40
Rated voltage 110-130 V, AC									
Red	1	1	MP1-11R 1SFA611100R1101	55.10	MLBL-04R 1SFA611621R1041	26.60	MCBH-11 1SFA611605R1111	34.70	116.40
Green	1	1	MP1-11G 1SFA611100R1102	55.10	MLBL-04G 1SFA611621R1042	26.60	MCBH-11 1SFA611605R1111	34.70	116.40
Yellow	1	1	MP1-11Y 1SFA611100R1103	55.10	MLBL-04Y 1SFA611621R1043	26.60	MCBH-11 1SFA611605R1111	34.70	116.40
Blue	1	1	MP1-11L 1SFA611100R1104	55.10	MLBL-04L 1SFA611621R1044	26.60	MCBH-11 1SFA611605R1111	34.70	116.40
White	1	1	MP1-11W 1SFA611100R1105	55.10	MLBL-04W 1SFA611621R1045	26.60	MCBH-11 1SFA611605R1111	34.70	116.40
Rated voltage 230 V, AC									
Red	1	1	MP1-11R 1SFA611100R1101	55.10	MLBL-07R 1SFA611621R1071	26.60	MCBH-11 1SFA611605R1111	34.70	116.40
Green	1	1	MP1-11G 1SFA611100R1102	55.10	MLBL-07G 1SFA611621R1072	26.60	MCBH-11 1SFA611605R1111	34.70	116.40
Yellow	1	1	MP1-11Y 1SFA611100R1103	55.10	MLBL-07Y 1SFA611621R1073	26.60	MCBH-11 1SFA611605R1111	34.70	116.40
Blue	1	1	MP1-11L 1SFA611100R1104	55.10	MLBL-07L 1SFA611621R1074	26.60	MCBH-11 1SFA611605R1111	34.70	116.40
White	1	1	MP1-11W 1SFA611100R1105	55.10	MLBL-07W 1SFA611621R1075	26.60	MCBH-11 1SFA611605R1111	34.70	116.40

Pilot Devices – Modular Type

Pilot Light

– Minimum Order Quantity: 10 pcs



Color	Head Order Code	Price	LED Order Code	Price	Holder Order Code	Price	Complete Unit Price (RM)
Rated voltage 24 V, AC/DC							
Red	ML1-100R 1SFA611400R1001	10.20	MLBL-01R 1SFA611621R1011	26.60	MCBH-00 1SFA611605R1100	3.10	39.90
Green	ML1-100G 1SFA611400R1002	10.20	MLBL-01G 1SFA611621R1012	26.60	MCBH-00 1SFA611605R1100	3.10	39.90
Yellow	ML1-100Y 1SFA611400R1003	10.20	MLBL-01Y 1SFA611621R1013	26.60	MCBH-00 1SFA611605R1100	3.10	39.90
Blue	ML1-100L 1SFA611400R1004	10.20	MLBL-01L 1SFA611621R1014	26.60	MCBH-00 1SFA611605R1100	3.10	39.90
White	ML1-100W 1SFA611400R1005	10.20	MLBL-01W 1SFA611621R1015	26.60	MCBH-00 1SFA611605R1100	3.10	39.90
Rated voltage 110-130 V, AC							
Red	ML1-100R 1SFA611400R1001	10.20	MLBL-04R 1SFA611621R1041	26.60	MCBH-00 1SFA611605R1100	3.10	39.90
Green	ML1-100G 1SFA611400R1002	10.20	MLBL-04G 1SFA611621R1042	26.60	MCBH-00 1SFA611605R1100	3.10	39.90
Yellow	ML1-100Y 1SFA611400R1003	10.20	MLBL-04Y 1SFA611621R1043	26.60	MCBH-00 1SFA611605R1100	3.10	39.90
Blue	ML1-100L 1SFA611400R1004	10.20	MLBL-04L 1SFA611621R1044	26.60	MCBH-00 1SFA611605R1100	3.10	39.90
White	ML1-100W 1SFA611400R1005	10.20	MLBL-04W 1SFA611621R1045	26.60	MCBH-00 1SFA611605R1100	3.10	39.90
Rated voltage 230 V, AC							
Red	ML1-100R 1SFA611400R1001	10.20	MLBL-07R 1SFA611621R1071	26.60	MCBH-00 1SFA611605R1100	3.10	39.90
Green	ML1-100G 1SFA611400R1002	10.20	MLBL-07G 1SFA611621R1072	26.60	MCBH-00 1SFA611605R1100	3.10	39.90
Yellow	ML1-100Y 1SFA611400R1003	10.20	MLBL-07Y 1SFA611621R1073	26.60	MCBH-00 1SFA611605R1100	3.10	39.90
Blue	ML1-100L 1SFA611400R1004	10.20	MLBL-07L 1SFA611621R1074	26.60	MCBH-00 1SFA611605R1100	3.10	39.90
White	ML1-100W 1SFA611400R1005	10.20	MLBL-07W 1SFA611621R1075	26.60	MCBH-00 1SFA611605R1100	3.10	39.90

Pilot Devices – Compact Type

Push Button

– Flush button

– Minimum Order Quantity: 10 pcs



Type	Color	NO	NC	Order Code	Complete Unit Price (RM)
Momentary					
CP1-10R-01	Red	0	1	1SFA619100R1041	19.50
CP1-10G-10	Green	1	0	1SFA619100R1012	19.50
CP1-10Y-10	Yellow	1	0	1SFA619100R1013	19.50
CP1-10L-10	Blue	1	0	1SFA619100R1014	19.50
CP1-10B-10	Black	1	0	1SFA619100R1016	19.50
CP1-10R-11	Red	1	1	1SFA619100R1071	29.60
CP1-10G-11	Green	1	1	1SFA619100R1072	29.60
CP1-10B-11	Black	1	1	1SFA619100R1076	29.60
CP1-10G-20	Green	2	0	1SFA619100R1022	29.60
CP1-10B-20	Black	2	0	1SFA619100R1026	29.60
Maintained					
CP2-10G-10	Green	1	0	1SFA619101R1012	52.00
CP2-10B-10	Black	1	0	1SFA619101R1016	52.00
CP2-10G-11	Green	1	1	1SFA619101R1072	52.00
CP2-10B-11	Black	1	1	1SFA619101R1076	52.00

Pilot Devices – Compact Type

Pilot Light with Integrated LED

- Service life >50 000 hours
- Minimum Order Quantity: 10 pcs



Type	Color	Order Code	List Price (RM)
Rated voltage 24 V, AC/DC			
CL2-502R	Red	1SFA619403R5021	23.60
CL2-502G	Green	1SFA619403R5022	23.60
CL2-502Y	Yellow	1SFA619403R5023	23.60
CL2-502L	Blue	1SFA619403R5024	23.60
CL2-502W	White	1SFA619403R5028	23.60
Rated voltage 110-130 V, AC			
CL2-513R	Red	1SFA619403R5131	23.60
CL2-513G	Green	1SFA619403R5132	23.60
CL2-513Y	Yellow	1SFA619403R5133	23.60
CL2-513L	Blue	1SFA619403R5134	23.60
CL2-513W	White	1SFA619403R5138	23.60
Rated voltage 230 V, AC			
CL2-523R	Red	1SFA619403R5231	23.60
CL2-523G	Green	1SFA619403R5232	23.60
CL2-523Y	Yellow	1SFA619403R5233	23.60
CL2-523L	Blue	1SFA619403R5234	23.60
CL2-523W	White	1SFA619403R5238	23.60



Emergency Stop Push Button (Red)

- Twist release

Type	NO	NC	Order Code	List Price (RM)
30mm				
CE3T-10R-01	0	1	1SFA619500R1041	68.40
CE3T-10R-11	1	1	1SFA619500R1071	68.40
40mm				
CE4T-10R-01	0	1	1SFA619550R1041	85.80
CE4T-10R-11	1	1	1SFA619550R1071	85.80

Electronic Products & Relays



Electronic Products & Relays

Single Phase Monitor

Current monitoring relays, single-phase AC/DC

CM-SRS.2S

- Monitoring of DC or AC current
- One device includes 3 measuring ranges
- Over- or undercurrent configurable
- With and without tripping time delay
- 22.5mm width
- Measuring ranges: 0.3-1.5A; 1-5A; 3-15A



Type	Rated Control Voltage 50/60Hz	Output Relays	Tripping delay Tv	Order Code	List Price (RM)
CM-SRS.12S	24-240V AC/DC	1 c/o contact	Without	1SVR730840R0300	976.40
CM-SRS.22S	24-240V AC/DC	2 c/o contacts	adjustable 0 or 0.1-30s	1SVR730840R0500	976.40

Voltage monitoring relays, single-phase AC/DC

CM-ESS.2S

- Monitoring of DC or AC voltages from 3-600 V
- One device includes 4 measuring ranges
- Over- And undervoltage monitoring configurable
- 3 supply voltage versions
- 3 LEDs for status indication
- 22.5mm width
- Double-chamber cage connection terminals
- Measuring ranges: 3-30V; 6-60V; 30-300V; 60-600V

Type	Rated Control Voltage 50/60Hz	Output Relays	Tripping delay Tv	Order Code	List Price (RM)
CM-ESS.2S	24-240V AC/DC	2 c/o contacts	adjustable 0 or 0.1-30s	1SVR730830R0400	1,170.30

Electronic Products & Relays

Three-phase monitors

CM-PVE

- Single and Three-phase monitoring
- Over- & undervoltage and Phase failure detection
- Available with or without neutral monitoring
- 1 n/o contact
- 1 LED for status indication



Type	Rated Control Voltage = measuring voltage	Neutral monitoring	Order Code	List Price (RM)
CM-PVE	3X320-460VAC, 185-265 VAC	With	1SVR550870R9400	566.40
CM-PVE	3X320-460VAC	Without	1SVR550871R9500	566.40

CM-PFS

- Three-phase monitoring: Phase sequence; Phase failure detection
- 2 c/o contacts
- LED for status indication

Type	Rated Control Voltage = measuring voltage	Order Code	List Price (RM)
CM-PFS.S	3x200-500 V AC 50/60Hz	1SVR730824R9300	387.30

CM-PVS

- Three phase monitoring: Phase sequence; Phase failure; Over- & undervoltage detection
- Threshold values for over & undervoltage are adjustable
- 2 c/o contacts
- 3 LEDs for status indication

Type	Rated Control Voltage = measuring voltage	Order Code	List Price (RM)
CM-PVS.31S	3x160-300 V AC	1SVR730794R1300	1,093.60
CM-PVS.41S	3x300-500 V AC	1SVR730794R3300	1,093.60

CM-MPS

- Three phase monitoring: Phase sequence; Phase failure; Over- & undervoltage; Phase unbalance detection
- With or without interrupted neutral monitoring
- Thresholds adjustable for over & undervoltage; Phase unbalance (Switch-off value)
- 2 c/o contacts
- Double-chamber cage connection terminals
- 3 LEDs for status indication

Type	Rated Control Voltage = measuring voltage	Interrupted Neutral monitoring	Order Code	List Price (RM)
CM-MPS.11S	3x90-170 V AC	with	1SVR730885R1300	1,093.60
CM-MPS.21S	3x180-280 V AC	with	1SVR730885R3300	1,093.60
CM-MPS.31S	3x160-300 V AC	without	1SVR730884R1300	1,093.60
CM-MPS.41S	3x300-500 V AC	without	1SVR730884R3300	1,093.60

Electronic Products & Relays

Thermistor motor protection relays



CM-MSS.1

- Replacement for CM-MSS(1)
- Auto Reset
- 2 LEDs for status indication
- 1 c/o contact

Type	Rated control supply voltage	Order Code	List Price (RM)
CM-MSS.12S	24 V AC/DC	1SVR730700R0100	475.10
CM-MSS.13S	220-240 V AC	1SVR730700R2100	475.10

CM-MSS.2

- Replacement for CM-MSS(2)
- Fault storage can be switched off
- Auto reset configurable; Reset button; Remote reset
- 2 LEDs for status indication
- 2 c/o contacts

Type	Rated control supply voltage	Order Code	List Price (RM)
CM-MSS.22S	24 V AC/DC	1SVR730700R0200	516.80
CM-MSS.23S	220-240 V AC	1SVR730700R2200	516.80

Electronic Products & Relays

Pluggable interface relays CR-M range

Miniature relays

- Integrated test button
- Cadmium-free contact material
- Width on socket: 27mm
- Interface relays with LED
- 12 different coil voltages:
DC : 12V, 24V, 48V, 60V, 110V, 125V, 220V
AC : 24V, 48V, 110V, 120V, 230V

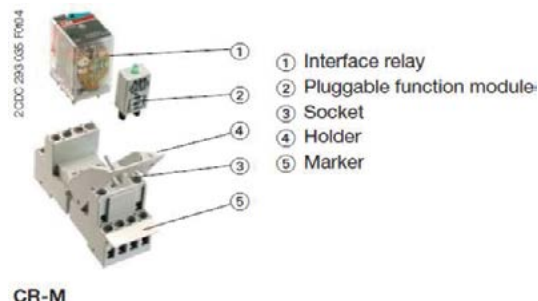

Type	Rated control supply voltage	Order Code	Packing Quantity	List Price (RM)
2 c/o contacts: 250V, 12A				
CR-M012DC2L	12V DC	1SVR405611R4100	10	31.50
CR-M024DC2L	24V DC	1SVR405611R1100	10	31.50
CR-M048DC2L	48V DC	1SVR405611R6100	10	31.50
CR-M060DC2L	60V DC	1SVR405611R4300	10	31.50
CR-M110DC2L	110V DC	1SVR405611R8100	10	31.50
CR-M125DC2L	125V DC	1SVR405611R8300	10	31.50
CR-M220DC2L	220V DC	1SVR405611R9100	10	31.50
CR-M024AC2L	24V AC	1SVR405611R0100	10	31.50
CR-M048AC2L	48V AC	1SVR405611R5100	10	31.50
CR-M110AC2L	110V AC	1SVR405611R7100	10	31.50
CR-M120AC2L	120V AC	1SVR405611R2100	10	31.50
CR-M230AC2L	230V AC	1SVR405611R3100	10	31.50
4 c/o contacts: 250V, 8A				
CR-M012DC4L	12V DC	1SVR405613R4100	10	39.50
CR-M024DC4L	24V DC	1SVR405613R1100	10	39.50
CR-M048DC4L	48V DC	1SVR405613R6100	10	39.50
CR-M060DC4L	60V DC	1SVR405613R4300	10	39.50
CR-M110DC4L	110V DC	1SVR405613R8100	10	39.50
CR-M125DC4L	125V DC	1SVR405613R8300	10	39.50
CR-M220DC4L	220V DC	1SVR405613R9100	10	39.50
CR-M024AC4L	24V AC	1SVR405613R0100	10	39.50
CR-M048AC4L	48V AC	1SVR405613R5100	10	39.50
CR-M110AC4L	110V AC	1SVR405613R7100	10	39.50
CR-M120AC4L	120V AC	1SVR405613R2100	10	39.50
CR-M230AC4L	230V AC	1SVR405613R3100	10	39.50

Electronic Products & Relays Accessories

Pluggable interface relays CR-M Accessories

Type	Version	Order Code	Packing Quantity	List Price (RM)
CR-M2SS	Standard socket	1SVR405651R1000	10	15.80
CR-M4SS	Standard socket	1SVR405651R3000	10	15.80
CR-MH	Plastic holder	1SVR405659R1000	10	4.60
CR-MJ	Jumper bar	1SVR405658R6000	10	29.30

Diode and LED - Reverse polarity protection/free wheeling diode

CR-P/M 42V	6-24 V DC green, A1+, A2-	1SVR405652R1000	10	19.20
CR-P/M 42BV	24-60 V DC green, A1+, A2-	1SVR405652R4100	10	19.20
CR-P/M 42CV	110-230 V DC green, A1+, A2-	1SVR405652R9100	10	19.20

Varistor and LED - Overvoltage protection

CR-P/M 62CV	6-24 V AC/DC green, for DC A1+, A2-	1SVR405655R1000	10	28.20
CR-P/M 62DV	24-60 V AC/DC green, for DC A1+, A2-	1SVR405655R4100	10	28.20
CR-P/M 92CV	110-230 V AC/DC green, for DC A1+, A2-	1SVR405655R1100	10	28.20

Electronic Products & Relays

Pluggable interface relays CR-U range

Universal relays

- Integrated test button
- Cadmium-free contact material
- Width on socket: 38mm
- Interface relays with LED
- 10 different coil voltages:
DC : 12V, 24V, 48V, 110V, 220V
AC : 24V, 48V, 110V, 230V

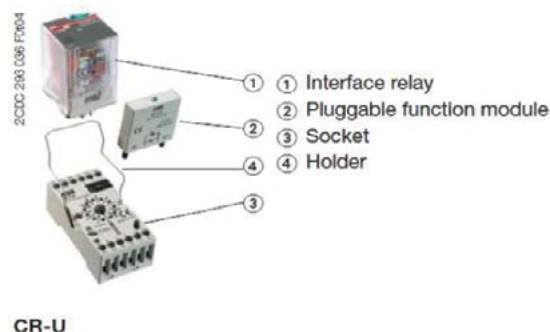

Type	Rated control supply voltage	Order Code	Packing Quantity	List Price (RM)
2 c/o contacts: 250V, 10A				
CR-U012DC2L	12V DC	1SVR405621R4100	10	31.50
CR-U024DC2L	24V DC	1SVR405621R1100	10	31.50
CR-U048DC2L	48V DC	1SVR405621R6100	10	31.50
CR-U110DC2L	110V DC	1SVR405621R8100	10	31.50
CR-U220DC2L	220V DC	1SVR405621R9100	10	31.50
CR-U024AC2L	24V AC	1SVR405621R0100	10	31.50
CR-U048AC2L	48V AC	1SVR405621R5100	10	31.50
CR-U110AC2L	110V AC	1SVR405621R7100	10	31.50
CR-U120AC2L	120V AC	1SVR405621R2100	10	31.50
CR-U230AC2L	230V AC	1SVR405621R3100	10	31.50
3 c/o contacts: 250V, 10A				
CR-U012DC3L	12V DC	1SVR405622R4100	10	39.50
CR-U024DC3L	24V DC	1SVR405622R1100	10	39.50
CR-U048DC3L	48V DC	1SVR405622R6100	10	39.50
CR-U110DC3L	110V DC	1SVR405622R8100	10	39.50
CR-U220DC3L	220V DC	1SVR405622R9100	10	39.50
CR-U024AC3L	24V AC	1SVR405622R0100	10	39.50
CR-U048AC3L	48V AC	1SVR405622R5100	10	39.50
CR-U110AC3L	110V AC	1SVR405622R7100	10	39.50
CR-U120AC3L	120V AC	1SVR405622R2100	10	39.50
CR-U230AC3L	230V AC	1SVR405622R3100	10	39.50

Accessories

Type	Version	Order Code	Packing Quantity	List Price (RM)
CR-U2S	Standard socket for 2 c/o	1SVR405670R0000	10	31.50
CR-U3S	Standard socket for 3 c/o	1SVR405660R0000	10	31.50
CR-U2SM	Socket small for 2 c/o	1SVR405670R1100	10	15.80
CR-U3SM	Socket small for 3 c/o	1SVR405660R1100	10	15.80
CR-UH	Plastic holder	1SVR405669R0000	10	15.80

Electronic Products & Relays

Pluggable interface relays CR-MX range

Miniature relays

- Cadmium-free contact material
- Width on socket : 27mm
- Available with or without LED
- 7 different coil voltages:
DC : 12V, 24V, 48V, 110V
AC : 24V, 110V, 230V

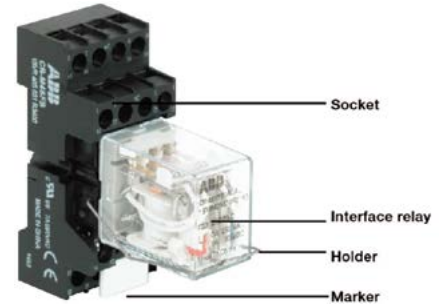

Type	Rated control supply voltage	Order Code	Packing Quantity	List Price (RM)
2 c/o contacts : 250V, 7A With LED				
CR-MX024DC2L	24 VDC	1SVR405631R1100	10	22.50
CR-MX230AC2L	230 VAC	1SVR405631R3100	10	22.50
4 c/o contacts : 250V, 5A With LED				
CR-MX024DC4L	24 VDC	1SVR405633R1100	10	25.30
CR-MX230AC4L	230 VAC	1SVR405633R3100	10	25.30
2 c/o contacts : 250V, 7A Without LED				
CR-MX024DC2	24 VDC	1SVR405631R1000	10	19.70
CR-MX230AC2	230 VAC	1SVR405631R3000	10	19.70
4 c/o contacts : 250V, 5A Without LED				
CR-MX024DC4	24 VDC	1SVR405633R1000	10	22.50
CR-MX230AC4	230 VAC	1SVR405633R3000	10	22.50

Accessories

Type	Version	Order Code	Packing Quantity	List Price (RM)
CR-M2SFB	Socket for 2c/o black color	1SVR405651R1400	10	11.40
CR-M4SFB	Socket for 2c/o or 4c/o black color	1SVR405651R3400	10	14.00

Electronic Products & Relays

Primary switch mode power supplies

CP-E range

- Adjustable output voltages
- High efficiency of up to 90%
- Low power dissipation and low heating
- Free convection cooling
(no forced cooling with ventilators)
- Open-circuit, overload and short-circuit stable
- Integrated input fuse
- LEDs for status indication
- Redundancy units offering true redundancy
- Signalling output/contact for output voltage OK
- Transistor on 24 V devices >18 W and <120 W
- Relay on 24 V devices ≥ 120 W



CP-E 24/2.5

Type	Rated Output Voltage/Current	Order Code	List Price (RM)
CP-E 24/0.75	24 V DC / 0.75 A	1SVR427030R0000	391.10
CP-E 24/1.25	24 V DC / 1.25 A	1SVR427031R0000	469.20
CP-E 24/2.5	24 V DC / 2.5 A	1SVR427032R0000	704.30
CP-E 24/5.0	24 V DC / 5.0 A	1SVR427034R0000	977.20
CP-E 24/10.0	24 V DC / 10.0 A	1SVR427035R0000	1,758.40
CP-E 24/20.0	24 V DC / 20.0 A	1SVR427036R0000	2,344.50



CP-RUD

Redundancy units for decoupling of two CP-E power supply units

Type	Designation	Order Code	List Price (RM)
CP-RUD	Redundancy unit, up to 5A	1SVR423418R9000	704.30
CP-A RU	Redundancy unit for CP-E/S/C range	1SVR427071R0000	1,641.40
CP-A CM	Control module for CP-A RU	1SVR427075R0000	672.10

A series of horizontal dotted lines for writing.

Wire Management and Connectivity (WMC)

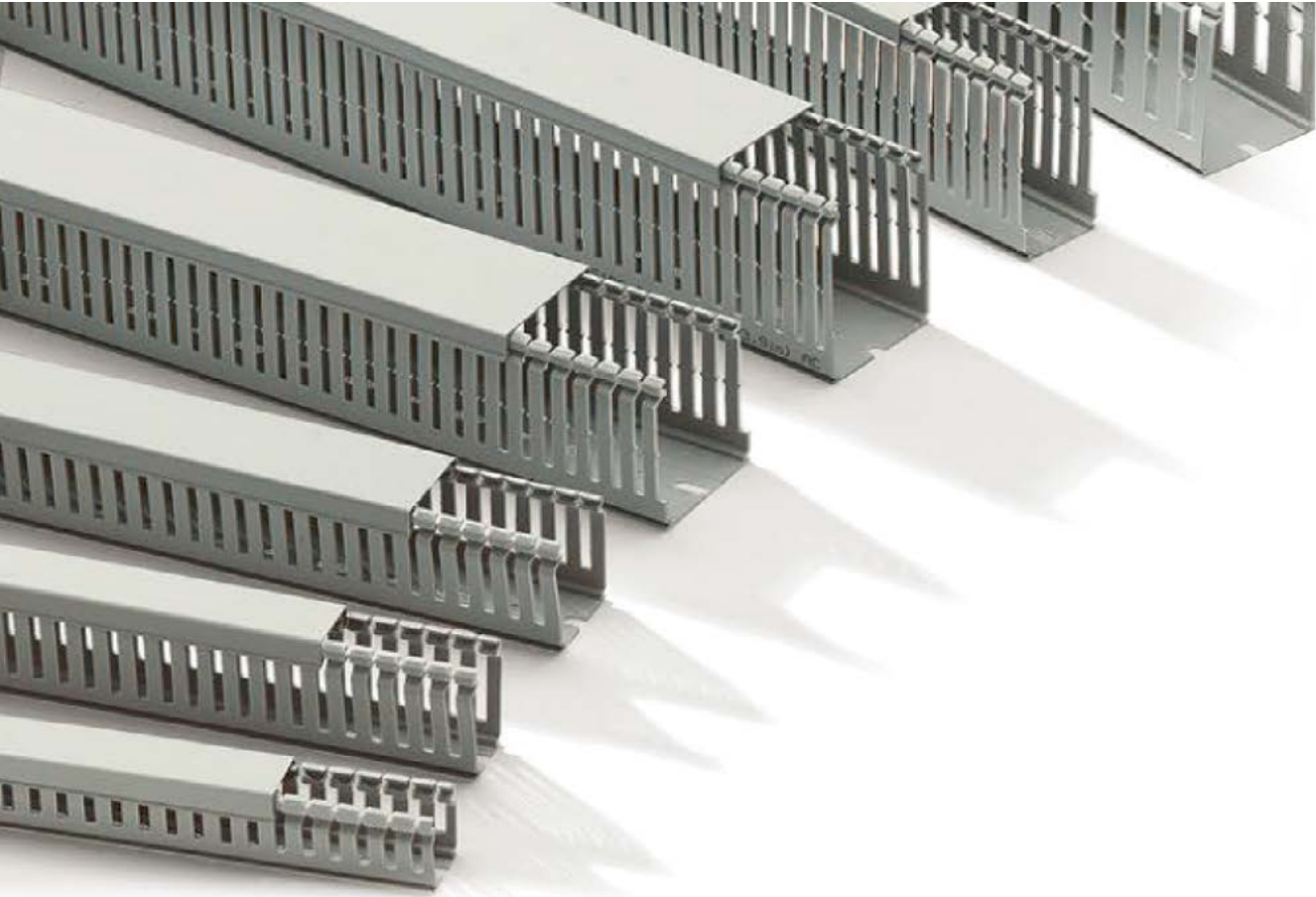

Power and productivity
for a better world™



Wire Management & Connectivity (WMC)

Ty-Rap® High Performance Cable Ties Polyamide 6.6 Cable Ties – Natural

Ty-Rap®



Technical Information

Material – Moulding	: Polyamide 6.6
Material – Locking barb	: 316 grade stainless steel
Temperature range	: -60°C to +85°C
Colour	: Natural
Flammability rating	: UL 94 V-2
Other properties	: Halogen free, Silicone free

Product Ref	Order Code	Length (mm)	Width (mm)	Thickness (mm)	Standard Pack	List Price per Pack (RM)
TY23M	7TAG009040R0009	92	2.4	1.0	1000	256.30
TYB2315M	7TAG009050R0002	178	2.4	1.0	1000	512.70
TY232M	7TAG009040R0005	203	2.4	1.0	1000	427.20
TY234M	7TAG009050R0000	356	2.4	1.0	1000	512.70
TY24M	7TAG009130R0007	140	3.6	1.1	1000	341.80
TY242M	7TAG009120R0000	204	3.6	1.1	1000	427.20
TY26M	7TAG009120R0002	284	3.6	1.1	1000	512.70
TY244M	7TCG009130R0005	368	3.6	1.1	1000	427.20
TY25M	7TAG009210R0042	186	4.8	1.3	1000	427.20
TY253M	7TAG009220R0001	295	4.8	1.3	1000	854.40
TY28M	7TAG009210R0048	361	4.8	1.4	1000	854.40
TY271M	7TCG009450R0162	150	7.6	1.5	500	384.50
TY272M	7TAG009340R0002	223	6.9	1.6	500	683.50
TY27M	7TAG009320R0003	340	6.9	1.6	500	555.30
TY275M	7TAG009330R0009	457	6.9	1.6	500	1,409.70
TY277M	7TAG009340R0003	617	6.9	1.6	500	1,366.90
TY29M	7TAG009330R0012	771	6.9	1.5	500	2,050.30
TY53510M	7TCG009380R0001	889	8.2	1.7	50	286.30
TY54513M	7TCG009380R0003	1143	8.2	1.7	50	299.10

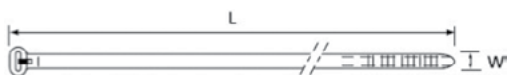

Wire Management & Connectivity (WMC)

Ty-Rap® High Performance Cable Ties Polyamide 6.6 Cable Ties – UV-Resistant Black

Ty-Rap®



Technical Information

Material – Moulding	: Polyamide 6.6
Material – Locking barb	: 316 grade stainless steel
Temperature range	: -60°C to +105°C
Colour	: Black
Flammability rating	: UL 94 V-2
Other properties	: UV-resistant, Halogen free, Silicone free

Product Ref	Order Code	Length (mm)	Width (mm)	Thickness (mm)	Standard Pack	List Price per Pack (RM)
TY23MX	7TAG009040R0011	92	2.4	1.0	1000	256.30
TYB2315MX	7TAG009050R0003	178	2.4	1.0	1000	512.60
TY232MX	7TAG009040R0007	203	2.4	1.0	1000	427.20
TY234MX	7TAG009050R0001	356	2.4	1.0	1000	512.60
TY24MX	7TAG009130R0009	140	3.6	1.1	1000	341.80
TY242MX	7TAG009130R0004	204	3.6	1.1	1000	427.20
TY26MX	7TAG009120R0004	284	3.6	1.1	1000	512.60
TY244MX	7TCG009130R0006	368	3.6	1.1	1000	427.20
TY25MX	7TAG009210R0045	186	4.8	1.3	1000	512.60
TY253MX	7TAG009220R0003	295	4.8	1.3	1000	854.30
TY28MX	7TAG009210R0050	361	4.8	1.4	1000	854.30
TY271MX	7TCG009450R0163	150	7.6	1.5	500	427.20
TY272MX	7TAG009330R0007	223	6.9	1.6	500	768.90
TY27MX	7TAG009320R0004	340	6.9	1.6	500	811.60
TY275MX	7TAG009320R0001	457	6.9	1.6	500	1,708.60
TY277MX	7TAG009330R0010	617	6.9	1.6	500	1,751.30
TY29MX	7TAG009330R0014	771	6.9	1.5	500	2,648.30
TY53510MX	7TCG009380R0002	889	8.2	1.7	50	294.80
TY54513MX	7TCG009380R0005	1143	8.2	1.7	50	294.80

13

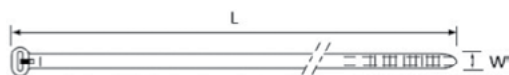

*NOTE: All List Prices Excluding 6% GST

Wire Management & Connectivity (WMC)

WIRING DUCTS

Thermoplastic Wiring Ducts with Vertical Slots

Wiring Ducts with 8/12 mm Slots

- Colour RAL 7030 grey.
- Plastic, insulating, shock-proof, self-extinguishing material.
- Maximum usage temperature +60°C.
- Resistant to acids, oils and greases.
- Designed to snap onto the Fix-O-rapid special accessory.
- Suitable to be fastened both to DIN rail and base plate.
- Standard 2 meter length.

Standards

Material in compliance with UL 94 V0 Standard and resistant to abnormal heat and fire up to 960°C (glow wire test) in compliance with IEC 695-2-1 Standard.



Product Ref	Order Code	Width (mm)	Height (mm)	Sold in UOM	Standard Pack (m)	MOQ (m)	List Price (RM) per Meters
05033	05033	25	30	Meters	58	116	11.60
05043	05043	25	40	Meters	48	96	12.10
05063	05063	25	60	Meters	34	68	16.90
05083	05083	25	80	Meters	28	56	25.10
05094	05094	25	100	Meters	20	40	30.40
05045	05045	40	40	Meters	30	60	15.00
05065	05065	40	60	Meters	22	44	18.90
05085	05085	40	80	Meters	36	72	29.00
05095	05095	40	100	Meters	28	56	34.70
05047	05047	60	40	Meters	40	80	20.30
05067	05067	60	60	Meters	32	64	30.40
05087	05087	60	80	Meters	24	48	39.40
05096	05096	60	100	Meters	20	40	30.20
05069	05069	80	60	Meters	24	48	27.90
05089	05089	80	80	Meters	16	32	47.00
05097	05097	80	100	Meters	14	28	42.80
05091	05091	100	80	Meters	16	32	42.80
05098	05098	100	100	Meters	8	16	59.10
05099	05099	150	100	Meters	8	16	81.60

Note: For thermoplastic wiring ducts with 4/6mm slots, Halogen free wiring ducts or Accessories, please contact ABB for more details.

Wire Management & Connectivity (WMC)

Thermoplastic Wiring Ducts Spare Covers



Product Ref	Order Code	Width (mm)	Sold in UOM	Standard Pack (Meters)	List Price (RM) per Meters
05300	05300	15	Meters	200	18.60
05302	05302	25	Meters	60	34.00
05304	05304	40	Meters	40	39.20
05306	05306	60	Meters	24	57.70
05308	05308	80	Meters	16	69.80
05310	05310	100	Meters	48	77.90
05312	05312	120	Meters	36	84.80
05314	05314	150	Meters	28	145.50

Wire Management & Connectivity (WMC)

Spec-Kon® Lugs Copper / Straight – One Hole Type

Technical Information

Terminal material	: High conductivity copper
Terminal surface treatment	: Tin plated
Voltage rating	: 600 V to 35 kV
Certification	: Comply to IEC 61238 (class B rating)



Product Ref.	Order Code	Cable Size (sq. mm)	Stud Hole Size (mm)	Dimension		Quantity per pack MOQ	List Price per Pack (RM)
				A (mm)	C (mm)		
6M5	7TCA302310R0017	6	M5	28.2	10.0	100	188.00
6M6	7TCA302310R0000	6	M6	28.2	10.8	100	188.00
6M8	7TCA302310R0001	6	M8	32.0	13.0	100	196.50
10M5	7TCA302310R0002	10	M5	32.3	11.0	100	230.70
10M6	7TCA302310R0003	10	M6	32.3	11.0	100	230.70
10M8	7TCA302310R0004	10	M8	32.3	13.0	100	222.20
10M10	7TCA302310R0005	10	M10	32.3	14.5	100	341.80
16M5	7TCA302310R0006	16	M5	35.7	13.0	100	307.60
16M6	7TCA302310R0007	16	M6	35.7	13.0	100	299.00
16M8	7TCA302310R0008	16	M8	35.7	13.0	100	290.50
16M10	7TCA302310R0009	16	M10	37.9	15.0	100	299.00
25M6	7TCA302310R0010	25	M6	40.0	14.0	100	444.30
25M8	7TCA302310R0011	25	M8	40.0	15.5	100	427.20
25M10	7TCA302310R0012	25	M10	40.0	15.5	100	401.60
35M6	7TCA302310R0013	35	M6	44.0	15.5	100	632.20
35M8	7TCA302310R0014	35	M8	44.0	15.5	100	606.60
35M10	7TCA302310R0015	35	M10	44.0	15.5	100	589.50
35M12	7TCA302310R0016	35	M12	49.5	21.5	100	640.70
50M6	7TCA302320R0000	50	M6	49.0	18.0	50	491.30
50M8	7TCA302320R0001	50	M8	49.0	18.0	50	478.40
50M10	7TCA302320R0002	50	M10	49.0	18.0	50	461.40
50M12	7TCA302320R0003	50	M12	52.5	23.0	50	487.00
70M6	7TCA302320R0004	70	M6	56.0	20.8	50	730.40
70M8	7TCA302320R0005	70	M8	56.0	20.8	50	726.20
70M10	7TCA302320R0006	70	M10	56.0	20.8	50	696.30
70M12	7TCA302320R0007	70	M12	56.0	20.8	50	666.40
95M8	7TCA302320R0008	95	M8	62.0	24.5	50	969.60

Wire Management & Connectivity (WMC)

Spec-Kon® Lugs Copper / Straight – One Hole Type

Technical Information

Terminal material	: High conductivity copper
Terminal surface treatment	: Tin plated
Voltage rating	: 600 V to 35 kV
Certification	: Comply to IEC 61238 (class B rating)



Product Ref.	Order Code	Cable Size (sq. mm)	Stud Hole Size (mm)	Dimension		Quantity per pack MOQ	List Price per Pack (RM)
				A (mm)	C (mm)		
95M10	7TCA302320R0009	95	M10	62.0	24.5	50	948.30
95M12	7TCA302320R0010	95	M12	62.0	24.5	50	926.90
95M16	7TCA302320R0011	95	M16	62.0	24.5	50	867.10
120M8	7TCA302320R0012	120	M8	66.5	27.5	50	1,362.60
120M10	7TCA302320R0013	120	M10	66.5	27.5	50	1,290.00
120M12	7TCA302320R0014	120	M12	66.5	27.5	50	1,230.20
120M16	7TCA302320R0015	120	M16	66.5	27.5	50	1,191.70
150M8	7TCA302330R0000	150	M8	73.0	30.5	20	844.10
150M10	7TCA302330R0001	150	M10	73.0	30.5	20	833.80
150M12	7TCA302330R0002	150	M12	73.0	30.5	20	815.00
150M16	7TCA302330R0003	150	M16	73.0	30.5	20	784.30
150M20	7TCA302330R0004	150	M20	76.5	30.5	20	782.60
185M10	7TCA302330R0005	185	M10	75.0	33.5	20	938.00
185M12	7TCA302330R0006	185	M12	75.0	33.5	20	920.90
185M16	7TCA302330R0007	185	M16	75.0	33.5	20	888.50
185M20	7TCA302330R0008	185	M20	80.0	33.5	20	903.90
240M10	7TCA302330R0009	240	M10	89.0	37.5	20	1,472.80
240M12	7TCA302330R0010	240	M12	89.0	37.5	20	1,450.60
240M16	7TCA302330R0011	240	M16	89.0	37.5	20	1,414.70
240M20	7TCA302330R0012	240	M20	89.0	37.5	20	1,368.60
300M10	7TCA302330R0013	300	M10	96.5	42.5	10	956.00
300M12	7TCA302330R0014	300	M12	96.5	42.5	10	943.20
300M16	7TCA302330R0015	300	M16	96.5	42.5	10	924.40
300M20	7TCA302330R0016	300	M20	96.5	42.5	10	907.30
400M12	7TCA302330R0017	400	M12	109.5	49.5	5	826.10
400M16	7TCA302330R0018	400	M16	109.5	49.5	5	816.30
400M20	7TCA302330R0019	400	M20	109.5	49.5	5	788.10

Wire Management & Connectivity (WMC)



Spec-Kon® Cable Ties Polyamide 6.6 Cable Ties – Natural

Technical Information

Material	: Polyamide 6.6
Temperature range	: -40°C to +85°C
Colour	: Natural
Flammability rating	: UL 94 V-2
Other properties	: Halogen free, Silicone free

Product Ref	Order Code	Length (mm)	Width (mm)	MOQ	Standard Pack	List Price per Pack (RM)
SKT100-80	7TCA300040R0000	100	2.5	10000	1000	85.50
SKT140-80	7TCA300040R0001	140	2.5	10000	1000	85.50
SKT160-80	7TCA300040R0002	160	2.5	10000	1000	85.50
SKT200-80	7TCA300040R0003	200	2.5	10000	1000	170.90
SKT140-180	7TCA300120R0000	140	3.6	10000	1000	170.90
SKT200-180	7TCA300120R0001	200	3.6	10000	1000	170.90
SKT300-180	7TCA300120R0002	300	3.6	10000	1000	256.30
SKT370-180	7TCA300120R0003	370	3.6	10000	1000	341.80
SKT188-220	7TCA300200R0000	188	4.8	5000	1000	170.90
SKT215-220	7TCA300200R0001	215	4.8	5000	1000	256.30
SKT250-220	7TCA300200R0002	250	4.8	5000	1000	256.30
SKT300-220	7TCA300200R0003	300	4.8	5000	1000	256.30
SKT370-220	7TCA300200R0004	370	4.8	5000	1000	341.80
SKT300-540	7TCA300280R0000	300	7.6	1000	500	256.30
SKT370-540	7TCA300280R0001	370	7.6	1000	500	299.00
SKT450-540-50	7TCA300260R0003	450	7.6	1000	50	47.00
SKT750-540-50	7TCA300260R0002	750	7.6	1000	50	81.20
SKT776-780-50	7TCA300340R0000	776	9.0	500	50	98.30
SKT912-780-50	7TCA300340R0001	912	9.0	500	50	106.80

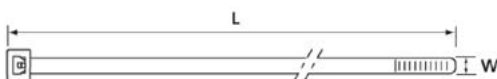

Wire Management & Connectivity (WMC)



Spec-Kon® Cable Ties

Polyamide 6.6 Cable Ties – UV-Resistant Black

Technical Information

Material – Moulding	: Polyamide 6.6
Temperature range	: -40°C to +85°C
Colour	: UV-Resistant Black
Flammability rating	: UL 94 V-2
Other properties	: UV-resistant, Halogen free, Silicone free

Product Ref	Order Code	Length (mm)	Width (mm)	MOQ	Standard Pack	List Price per Pack (RM)
SKT100-80X	7TCA300080R0000	100	2.5	10000	1000	85.50
SKT140-80X	7TCA300080R0001	140	2.5	10000	1000	85.50
SKT160-80X	7TCA300080R0002	160	2.5	10000	1000	85.50
SKT200-80X	7TCA300080R0003	200	2.5	10000	1000	85.50
SKT140-180X	7TCA300160R0000	140	3.6	10000	1000	85.50
SKT200-180X	7TCA300160R0001	200	3.6	10000	1000	170.90
SKT300-180X	7TCA300160R0002	300	3.6	10000	1000	256.30
SKT370-180X	7TCA300160R0003	370	3.6	10000	1000	341.80
SKT188-220X	7TCA300240R0000	188	4.8	5000	1000	170.90
SKT215-220X	7TCA300240R0001	215	4.8	5000	1000	256.30
SKT250-220X	7TCA300240R0002	250	4.8	5000	1000	256.30
SKT300-220X	7TCA300240R0003	300	4.8	5000	1000	341.80
SKT370-220X	7TCA300240R0004	370	4.8	5000	1000	341.80
SKT300-540X	7TCA300320R0000	300	7.6	1000	500	299.00
SKT370-540X	7TCA300320R0001	370	7.6	1000	500	341.80
SKT450-540X-50	7TCA300300R0003	450	7.6	1000	50	42.80
SKT750-540X-50	7TCA300300R0002	750	7.6	1000	50	72.70
SKT776-780X-50	7TCA300360R0000	776	9.0	500	50	85.50
SKT912-780X-50	7TCA300360R0001	912	9.0	500	50	115.40

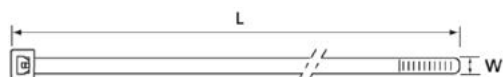

A series of horizontal dotted lines for writing.

Cable Protection, Explosion Proof and Lighting (CEL)



Cable Protection, Explosion Proof and Lighting (CEL)

Adaptaflex Non-Metallic Conduit Systems

Type PA – Light Weight Conduit

Colour	: Black (BL)
Materials	: Polyamide (Nylon) 6
UV Resistance	: Very High
Flexibility & Fatigue Life	: High Flexibility – High Fatigue Life
Fire Performance & EMI Screen	: Self Extinguishing, Halogen Free
Temperature Range	: Static Application: -40°C to +120°C Moving Application: -5°C to +120°C



Product Ref	Order Code	Nominal	NW	Diameter (mm)		Reel Length (MOQ)	List Price per reel (RM)
		Conduit Size (mm)	Conduit Size	Outside	Inside		
PAFL13/BL/50M	7TCA296000R2093	13	10	13.0	10.0	50m	407.80
PAFL16/BL/50M	7TCA296000R2107	16	13	15.8	11.9	50m	558.10
PAFL21/BL/50M	7TCA296000R2125	21	17	21.2	16.8	50m	895.50
PAFL28/BL/50M	7TCA296000R1926	28	23	28.5	22.2	50m	1,622.70
PAFL34/BL/50M	7TCA296000R1937	34	29	34.5	27.9	50m	1,940.80
PAFL42/BL/25M	7TCA296000R1947	42	36	42.5	35.2	25m	1,002.60
PAFL54/BL/25M	7TCA296000R1958	54	48	54.5	46.9	25m	1,604.40

Type PA-Standard Weight Conduit



Product Ref	Order Code	Nominal	NW	Diameter (mm)		Reel Length (MOQ)	List Price per reel (RM)
		Conduit Size (mm)	Conduit Size	Outside	Inside		
PAFS10/BL/50M	7TCA296000R2143	10	7.5	10.0	6.5	50m	356.40
PAFS13/BL/50M	7TCA296000R2155	13	10	13.0	9.6	50m	468.80
PAFS16/BL/50M	7TCA296000R2176	16	13	15.8	11.8	50m	628.00
PAFS21/BL/50M	7TCA296000R2207	21	17	21.2	16.5	50m	1,038.10
PAFS28/BL/50M	7TCA296000R2234	28	23	28.5	22.6	50m	1,664.40
PAFS34/BL/50M	7TCA296000R2251	34	29	34.5	28.8	50m	2,103.60
PACS42/BL/25M	7TCA296000R2015	42	36	42.5	35.2	25m	1,359.90
PACS54/BL/25M	7TCA296000R2033	54	48	54.5	46.5	25m	1,942.00
PACS80/BL/10M	7TCA296000R2047	80	70	79.3	67.0	10m	3,205.80
PACS106/BL/10M	7TCA296000R1966	106	95	106.0	91.5	10m	4,111.60

Cable Protection, Explosion Proof and Lighting (CEL)

Adaptaflex Non-Metallic Conduit Systems

Type A – Adaptalok

Straight Fitting

Colour : Black (BL)
Materials : Polyamide (Nylon) 6
Temperature Range : Static Application: -50°C to + 120°C
Moving Application: -45°C to + 120°C



Product Ref	Order Code	Nominal Conduit Size (mm)	Metric Thread	(MOQ)	List Price per pc (RM)
AL10/M12/A/BL	7TCA296000R0134	10	M16	10	12.90
AL13/M16/A/BL	7TCA296000R0188	13	M16	10	18.20
AL13/M20/A/BL	7TCA296000R0212	13	M20	10	22.50
AL16/M16/A/BL	7TCA296000R0350	16	M16	10	18.80
AL16/M20/A/BL	7TCA296000R0384	16	M20	10	11.00
AL21/M20/A/BL	7TCA296000R0585	21	M20	10	12.60
AL21/M25/A/BL	7TCA296000R0620	21	M25	10	37.70
AL28/M25/A/BL	7TCA296000R0797	28	M25	10	14.10
AL28/M32/A/BL	7TCA296000R0832	28	M32	10	33.20
AL34/M32/A/BL	7TCA296000R0957	34	M32	10	34.30
AL34/M40/A/BL	7TCA296000R0983	34	M40	10	40.30
AL42/M40/A/BL	7TCA296000R1081	42	M40	2	61.80
AL42/M50/A/BL	7TCA296000R1106	42	M50	2	47.50
AL54/M50/A/BL	7TCA296000R1213	54	M50	2	72.20
AL54/M63/A/BL	7TCA296000R1236	54	M63	2	98.40

Cable Protection, Explosion Proof and Lighting (CEL)

ABB Kopex-EX Cable Gland



C1 Series – Ex d e double compression cable gland

Features

- 4 function double compression cable gland
- Suitable for use with SWA (Steel Wire Armoured), SWB (Steel Wire Braid) or AWA (Aluminium Wire Armoured)
- Flameproof Ex d and increased safety Ex e
- Available in brass, nickel plated brass and stainless steel 316
- Metric Thread



Sealing Range (mm)		Metric Thread Size	Product Ref	Order Code	List Price (RM)
D (min-max)	D1 (min-max)				
3 - 8.5	6.0 - 12.0	M16 x 1.5	EXN03MSC1K	7TCA297180R0539	374.00
6.0 - 12.0	8.5 - 16.0	M16 x 1.5	EXN03MMC1K	7TCA297180R0540	380.50
3 - 8.5	6.0 - 12.0	M20 x 1.5	EXN04MSC1K	7TCA297180R0361	288.60
6.0 - 12.0	8.5 - 16.0	M20 x 1.5	EXN04MMC1K	7TCA297180R0362	293.80
12 - 14.5	16.0 - 20.0	M20 x 1.5	EXN04MLC1K	7TCA297180R0363	343.40
6.0 - 12.0	8.5 - 16.0	M25 x 1.5	EXN05MSC1K	7TCA297180R0364	388.50
12.0 - 16.0	16.0 - 12.0	M25 x 1.5	EXN05MMC1K	7TCA297180R0365	407.60
12.0 - 20.0	16.0 - 26.0	M25 x 1.5	EXN05MLC1K	7TCA297180R0366	542.60
12.0 - 20.0	16.0 - 26.0	M32 x 1.5	EXN06MSC1K	7TCA297180R0367	381.50
15.0 - 26.0	20.0 - 33.0	M32 x 1.5	EXN06MMC1K	7TCA297180R0368	725.20
15.0 - 26.0	20.0 - 33.0	M40 x 1.5	EXN07MSC1K	7TCA297180R0369	1,036.20
20.0 - 32.0	29.0 - 41.0	M40 x 1.5	EXN07MMC1K	7TCA297180R0370	1,158.50
22.0 - 35.0	33.0 - 48.0	M50 x 1.5	EXN08MSC1K	7TCA297180R0371	1,701.50
27.0 - 41.0	36.0 - 52.0	M50 x 1.5	EXN08MMC1K	7TCA297180R0372	1,827.10
35.0 - 45.0	43.0 - 57.0	M65 x 1.5	EXN09MSC1K	7TCA297180R0373	2,773.60
40.0 - 52.0	47.0 - 60.0	M65 x 1.5	EXN09MMC1K	7TCA297180R0374	3,013.10
40.0 - 52.0	47.0 - 60.0	M70 x 1.5	EXN10MSC1K	7TCA297180R0375	5,263.90
45.0 - 60.0	54.0 - 70.0	M70 x 1.5	EXN10MMC1K	7TCA297180R0376	5,613.10
45.0 - 60.0	54.0 - 70.0	M90 x 1.5	EXN11MSC1K	7TCA297180R0974	7,681.50
60.0 - 72.0	63.0 - 80.0	M90 x 1.5	EXN11MMC1K	7TCA297180R0897	6,109.70

** For Brass version, remove N to the reference, e.g. EX03MSC1 for Metric / EX03ASC1 for NPT

** For Stainless Steel version, add S to the reference e.g. EXS03MSC1 for Metric / EXS03ASC1 for NPT

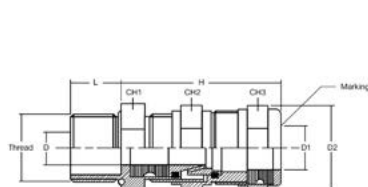

Metric Thread



Cable Protection, Explosion Proof and Lighting (CEL)

ABB Kopex-EX Cable Gland

C1 Series – Ex d e double compression cable gland

Features

- 4 function double compression cable gland
- Suitable for use with SWA (Steel Wire Armoured), SWB (Steel Wire Braid) or AWA (Aluminium Wire Armoured)
- Flameproof Ex d and increased safety Ex e
- Available in brass, nickel plated brass and stainless steel 316
- NPT Thread



Sealing Range (mm)		NPT	Product Ref	Order Code	List Price (RM)
D (min-max)	D1 (min-max)	Thread Size			
3 - 8.5	6.0 - 12.0	3/8"	EXN03ASC1K	7TCA297180R0541	374.00
6.0 - 12.0	8.5 - 16.0	3/8"	EXN03AMC1K	7TCA297180R0542	380.50
3 - 8.5	6.0 - 12.0	1/2"	EXN04ASC1K	7TCA297180R0377	288.60
6.0 - 12.0	8.5 - 16.0	1/2"	EXN04AMC1K	7TCA297180R0378	293.80
12 - 14.5	16.0 - 20.0	1/2"	EXN04ALC1K	7TCA297180R0379	249.90
6.0 - 12.0	8.5 - 16.0	3/4"	EXN05ASC1K	7TCA297180R0380	282.70
12.0 - 16.0	16.0 - 12.0	3/4"	EXN05AMC1K	7TCA297180R0381	407.60
12.0 - 20.0	16.0 - 26.0	3/4"	EXN05ALC1K	7TCA297180R0382	394.80
12.0 - 20.0	16.0 - 26.0	1"	EXN06ASC1K	7TCA297180R0383	381.50
15.0 - 26.0	20.0 - 33.0	1"	EXN06AMC1K	7TCA297180R0384	725.20
15.0 - 26.0	20.0 - 33.0	1 1/4"	EXN07ASC1K	7TCA297180R0385	753.90
20.0 - 32.0	29.0 - 41.0	1 1/4"	EXN07AMC1K	7TCA297180R0386	842.90
22.0 - 35.0	33.0 - 48.0	1 1/2"	EXN08ASC1K	7TCA297180R0387	1,237.80
27.0 - 41.0	36.0 - 52.0	1 1/2"	EXN08AMC1K	7TCA297180R0388	1,329.30
35.0 - 45.0	43.0 - 57.0	2"	EXN09ASC1K	7TCA297180R0389	2,017.80
40.0 - 52.0	47.0 - 60.0	2"	EXN09AMC1K	7TCA297180R0390	2,192.10
40.0 - 52.0	47.0 - 60.0	2 1/2"	EXN10ASC1K	7TCA297180R0391	3,829.60
45.0 - 60.0	54.0 - 70.0	2 1/2"	EXN10AMC1K	7TCA297180R0392	4,083.50
45.0 - 60.0	54.0 - 70.0	3"	EXN11ASC1K	7TCA297180R0904	7,681.50
60.0 - 72.0	63.0 - 80.0	3"	EXN11AMC1K	7TCA297180R0899	8,348.30

** For Brass version, remove N to the reference, e.g. EX03MSC1 for Metric / EX03ASC1 for NPT

** For Stainless Steel version, add S to the reference e.g. EXS03MSC1 for Metric / EXS03ASC1 for NPT

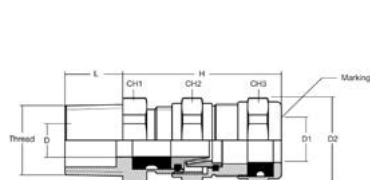

NPT Thread



*NOTE: All List Prices Excluding 6% GST

Cable Protection, Explosion Proof and Lighting (CEL)

ABB Kopex-EX Cable Gland



C2 Series – Ex d e single compression cable gland

Features

- Flameproof Ex d and increased safety Ex e
- Available in brass, nickel plated brass and stainless steel 316
- Wide range of cable sizes
- Kits available
- Metric Thread



Sealing Range (mm)		Metric Thread Size	Product Ref	Order Code	List Price (RM)
Min	Max				
4	12	M16 X 1.5	EXN03MMC2K	7TCA297180R0574	218.50
4	12	M20 X 1.5	EXN04MMC2K	7TCA297180R0406	227.50
10	16	M20 X 1.5	EXN04MLC2K	7TCA297180R0407	231.70
10	18	M25 X 1.5	EXN05MMC2K	7TCA297180R0408	210.90
14	20	M25 X 1.5	EXN05MLC2K	7TCA297180R0409	219.80
14	24	M32 X 1.5	EXN06MMC2K	7TCA297180R0410	249.80
22	28	M32 X 1.5	EXN06MLC2K	7TCA297180R0411	256.60
22	32	M40 X 1.5	EXN07MMC2K	7TCA297180R0412	510.00
26	34	M40 X 1.5	EXN07MLC2K	7TCA297180R0413	522.30
26	35	M50 X 1.5	EXN08MSC2K	7TCA297180R0575	1,311.50
35	44	M50 X 1.5	EXN08MMC2K	7TCA297180R0414	776.20
35	45	M63 X 1.5	EXN09MSC2K	7TCA297180R0576	1,695.20
46	56	M63 X 1.5	EXN09MMC2K	7TCA297180R0415	1,003.20
46	62	M70 X 1.5	EXN10MSC2K	7TCA297180R0896	1,162.20
60	70	M70 X 1.5	EXN10MMC2K	7TCA297180R0949	1,716.30
60	70	M90 X 1.5	EXN11MSC2K	7TCA297180R0947	3,516.70
75	85	M90 X 1.5	EXN11MMC2K	7TCA297180R1005	4,036.30
75	85	M100 X 1.5	EXN12MSC2K	7TCA297180R0990	4,132.40
85	95	M110 X 1.5	EXN12MMC2K	7TCA297180R0951	4,632.30

** For Brass version, remove N to the reference, e.g. EX03MSC2 for Metric / EX03ASC2 for NPT

** For Stainless Steel version, add S to the reference e.g. EXS03MSC1 for Metric / EXS03ASC1 for NPT

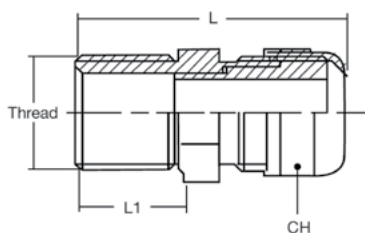

Metric Thread

Cable Protection, Explosion Proof and Lighting (CEL)

ABB Kopex-EX Cable Gland

C2 Series – Ex d e single compression cable gland

Features

- Flameproof Ex d and increased safety Ex e
- Available in brass, nickel plated brass and stainless steel 316
- Wide range of cable sizes
- Kits available
- NPT Thread



Sealing Range (mm)		NPT Thread Size	Product Ref	Order Code	List Price (RM)
Min	Max				
4	12	3/8"	EXN03AMC2K	7TCA297180R0577	218.50
4	12	1/2"	EXN04AMC2K	7TCA297180R0578	228.40
10	16	1/2"	EXN04ALC2K	7TCA297180R0579	232.40
10	18	3/4"	EXN05AMC2K	7TCA297180R0580	290.50
14	20	3/4"	EXN05ALC2K	7TCA297180R0581	302.80
14	24	1"	EXN06AMC2K	7TCA297180R0582	428.80
22	28	1"	EXN06ALC2K	7TCA297180R0583	440.20
22	32	1 1/4"	EXN07AMC2K	7TCA297180R0584	875.40
26	34	1 1/4"	EXN07ALC2K	7TCA297180R0585	896.70
26	35	1 1/2"	EXN08ASC2K	7TCA297180R0587	1,311.50
35	41	1 1/2"	EXN08AMC2K	7TCA297180R0586	1,332.80
35	45	2"	EXN09ASC2K	7TCA297180R0589	1,695.20
46	56	2"	EXN09AMC2K	7TCA297180R0588	1,722.20
46	62	2 1/2"	EXN10ASC2K	7TCA297180R0920	1,649.90
60	70	2 1/2"	EXN10AMC2K	7TCA297180R0928	1,716.30
60	70	3"	EXN11ASC2K	7TCA297180R0922	3,516.70
75	85	3"	EXN11AMC2K	7TCA297180R0921	4,036.30
75	85	4"	EXN12ASC2K	7TCA297180R0926	4,132.40
85	95	4"	EXN12AMC2K	7TCA297180R0923	4,632.30

** For Brass version, remove N to the reference, e.g. EX03MSC2 for Metric / EX03ASC2 for NPT

** For Stainless Steel version, add S to the reference e.g. EXS03MSC1 for Metric / EXS03ASC1 for NPT

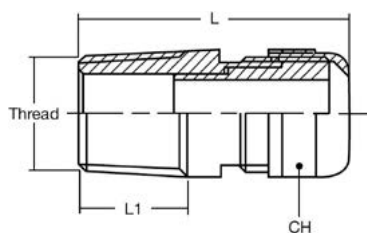

NPT Thread



Cable Protection, Explosion Proof and Lighting (CEL)

ABB DTS Light Fittings

Tubular fluorescent fitting, XFF – Zones 1, 2 & 21, 22

Features

- Manufactured from marine grade aluminium alloy copper free
- UV protected polycarbonate tube – Thickness 2.5mm or borosilicate glass – Thickness 7mm
- Rated voltage 100-240Vac 50/60Hz
- Wiring configuration : 5 wires



5 wires: Polycarbonate Diffuser Equipped with 1 cable gland & 1 plug

Light Rating (W)	Battery (H)	Gas	Product Ref	Order Code	List Price (RM)
1 x 18	–	IIC	XFR120-0G000	7TCA119300R0292	3,035.80
1 x 36	–	IIC	XFR140-0G000	7TCA119300R0329	3,422.90
1 x 56	–	IIC	XFR165-0G000	7TCA119300R0349	3,522.70
2 x 18	–	IIC	XFF220-0G000	7TCA119300R0100	3,141.90
2 x 36	–	IIC	XFF240-0G000	7TCA119300R0188	2,954.40
2 x 56	–	IIC	XFF265-0G000	7TCA119300R0255	3,830.60
1 x 18	3	IIC	XFR120EM-0G000	7TCA119320R0070	5,999.90
1 x 36	3	IIC	XFR140EM-0G000	7TCA119320R0078	6,434.40
2 x 18	3	IIC	XFF220EM-0G000	7TCA119320R0013	5,955.90
2 x 36	3	IIC	XFF240EM-0G000	7TCA119320R0032	6,489.10

Cable Protection, Explosion Proof and Lighting (CEL)

Fluorescent fitting with easy disconnect EVS – Zones 1,2 & 21, 22

Features

- Main body constructed of glass reinforced polyester for high impact strength
- UV protected polycarbonate diffuser to resist harsh environments
- Rated voltage 220-240Vac/Vdc 50-60Hz
- EOL (End of life) the ballast prevents the lamp cap at the end of lamp life cycle from overheating
- Wiring configuration : 5 wires
- 3 x Entries M20



5 wires: Equipped with 1 cable gland & 2 plugs

Light Rating (W)	Battery (H)	Gas	Product Ref	Order Code	List Price (RM)
1 x 18	-	0.09	EVS120-0000	7TCA119100R0012	3,737.20
1 x 36	-	0.17	EVS140-0000	7TCA119100R0028	4,706.70
1 x 56	-	0.26	EVS165-0000	7TCA119100R0045	5,245.60
2 x 18	-	0.17	EVS220-0000	7TCA119100R0066	3,709.50
2 x 36	-	0.33	EVS240-0000	7TCA119100R0101	4,017.10
2 x 56	-	0.5	EVS265-0000	7TCA119100R0169	5,621.30
1 x 18	3	0.09	EVS120EME-0000	7TCA119110R0007	8,261.10
1 x 36	3	0.17	EVS140EM-0000	7TCA119110R0011	10,491.20
2 x 18	3	0.17	EVS220EME-0000	7TCA119110R0018	7,272.20
2 x 36	3	0.33	EVS240EM-0000	7TCA119110R0028	7,696.00
2 x 56	3	0.5	EVS265EM-0000	7TCA119110R0070	8,002.50

*Fluorescent fitting with easy disconnect

Cable Protection, Explosion Proof and Lighting (CEL)

ABB DTS Light Fittings

HPS, MH or Halogen Floodlight fitting XSF, XQF, XEF – Zones 1, 2 & 21, 22 Features

- Manufactured from marine grade aluminium alloy-copper free
- Toughened borosilicate glass – Thickness 12mm
- Rated voltage standard : 230Vac 50Hz
option : 220Vac 60Hz or 120Vac 60Hz depending on models – Ferromagnetic
- 2 x Entries M20



Light Rating (W)	Mounting	Beam	Product Ref	Order Code	List Price (RM)
XSF floodlight – High Pressure Sodium - wide beam - 230V 50Hz					
1 x 150 HP Sodium	Flat	Wide	XSF150P-00000	7TCA119500R0085	10,391.00
1 x 150 HP Sodium	Pole	Wide	XSF150G-00000	7TCA119500R0081	10,150.60
1 x 250 HP Sodium	Flat	Wide	XSF250P-00000	7TCA119500R0103	10,888.60
1 x 250 HP Sodium	Pole	Wide	XSF250G-00000	7TCA119500R0099	10,647.00
1 x 400 HP Sodium	Flat	Wide	XSF400P-00000	7TCA119500R0125	11,181.90
1 x 400 HP Sodium	Pole	Wide	XSF400G-00000	7TCA119500R0120	10,965.80
XSF floodlight – High Pressure Sodium - wide beam - 220V 60Hz					
1 x 150 HP Sodium	Flat	Wide	XSF150P-0D000	7TCA119500R0089	10,497.00
1 x 150 HP Sodium	Pole	Wide	XSF150G-0D000	7TCA119500R0170	8,244.10
1 x 250 HP Sodium	Flat	Wide	XSF250P-0D000	7TCA119500R0108	10,735.80
1 x 250 HP Sodium	Pole	Wide	XSF250G-0D000	7TCA119500R0172	7,282.80
1 x 400 HP Sodium	Flat	Wide	XSF400P-0D000	7TCA119500R0134	11,055.10
1 x 400 HP Sodium	Pole	Wide	XSF400G-0D000	7TCA119500R0123	11,145.20
XSF floodlight – High Pressure Sodium - wide beam - 120V 60Hz					
1 x 400 HP Sodium	Flat	Wide	XSF400P-0F000	7TCA119500R0140	15,671.40
1 x 400 HP Sodium	Pole	Wide	XSF400G-0F000	7TCA119500R0167	14,576.20

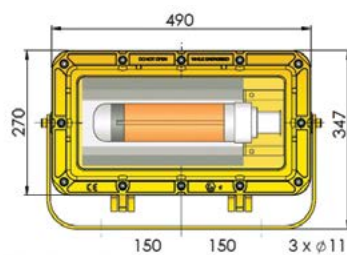

XQF250P - flat mounting

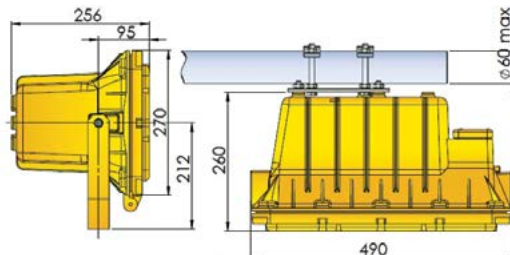

XQF250G - pole mounting

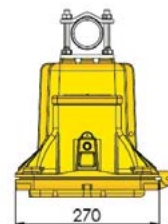

Cable Protection, Explosion Proof and Lighting (CEL)

ABB DTS Light Fittings

HPS, MH or Halogen Floodlight fitting XSF, XQF, XEF – Zones 1, 2 & 21, 22
Features

- Manufactured from marine grade aluminium alloy-copper free
- Toughened borosilicate glass – Thickness 12mm
- Rated voltage standard : 230Vac 50Hz
option : 220Vac 60Hz or 120Vac 60Hz depending on models – Ferromagnetic
- 2 x Entries M20



Light Rating (W)	Mounting	Beam	Product Ref	Order Code	List Price (RM)
XQF floodlight – Metal Halide - wide beam - 230V 50Hz					
1 x 250 Metal Halide	Flat	Wide	XQF250P-00000	7TCA119500R0051	11,104.40
1 x 250 Metal Halide	Pole	Wide	XQF250G-00000	7TCA119500R0049	10,917.70
1 x 400 Metal Halide	Flat	Wide	XQF400P-00000	7TCA119500R0064	11,274.50
1 x 400 Metal Halide	Pole	Wide	XQF400G-00000	7TCA119500R0059	11,253.20
XQF floodlight – Metal Halide - wide beam - 220V 60Hz					
1 x 250 Metal Halide	Flat	Wide	XQF250P-0D000	7TCA119500R0057	10,935.50
1 x 250 Metal Halide	Pole	Wide	XQF250G-0D000	7TCA119500R0168	10,890.10
1 x 400 Metal Halide	Flat	Wide	XQF400P-0D000	7TCA119500R0070	12,787.20
1 x 400 Metal Halide	Pole	Wide	XQF400G-0D000	7TCA119500R0169	11,306.60

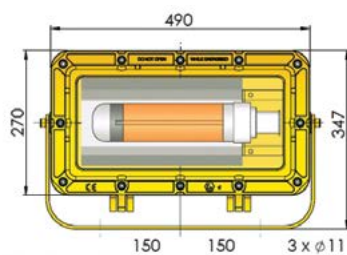

XQF250P - flat mounting

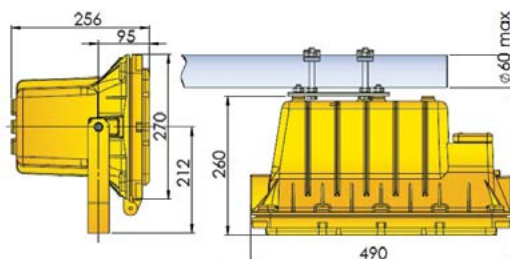

XQF250G - pole mounting

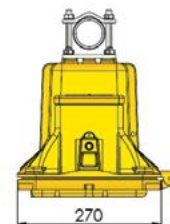

270

A series of horizontal dotted lines for writing.

Low Voltage Products Solutions for Solar Energy

Low Voltage Products

Solutions for Solar Energy

S 800 PV-S MCB

Standard: IEC/EN 60947-2

Icu = 5kA

Voltage range:

2P : 800 VDC

3P : 1000 VDC

4P : 1200 VDC



2 Poles

Rating	Model	Order Code	List Price (RM)
10	S802PV-S10	2CCP842001R1109	921.60
13	S802PV-S13	2CCP842001R1139	921.60
16	S802PV-S16	2CCP842001R1169	921.60
20	S802PV-S20	2CCP842001R1209	921.60
25	S802PV-S25	2CCP842001R1259	921.60
32	S802PV-S32	2CCP842001R1329	921.60
40	S802PV-S40	2CCP842001R1409	1028.80
50	S802PV-S50	2CCP842001R1509	1028.80
63	S802PV-S63	2CCP842001R1639	1028.80
80	S802PV-S80	2CCP842001R1809	1326.70
100	S802PV-S100	2CCP842001R1829	1326.70
125	S802PV-S125	2CCP842001R1849	1366.10

3 Poles

Rating (A)	Model	Order Code	List Price (RM)
10	S803PV-S10	2CCP843001R1109	1297.10
13	S803PV-S13	2CCP843001R1139	1297.10
16	S803PV-S16	2CCP843001R1169	1297.10
20	S803PV-S20	2CCP843001R1209	1297.10
25	S803PV-S25	2CCP843001R1259	1297.10
32	S803PV-S32	2CCP843001R1329	1297.10
40	S803PV-S40	2CCP843001R1409	1449.70
50	S803PV-S50	2CCP843001R1509	1449.70
63	S803PV-S63	2CCP843001R1639	1449.70
80	S803PV-S80	2CCP843001R1809	1870.90
100	S803PV-S100	2CCP843001R1829	1870.90
125	S803PV-S125	2CCP843001R1849	1932.30

Low Voltage Products Solutions for Solar Energy

S 800 PV-S MCB

Standard: IEC/EN 60947-2

Icu = 5kA

Voltage range:

2P : 800 VDC

3P : 1000 VDC

4P : 1200 VDC



4 Poles

Rating	Model	Order Code	List Price (RM)
10	S804PV-S10	2CCP844001R1109	1,833.70
13	S804PV-S13	2CCP844001R1139	1,833.70
16	S804PV-S16	2CCP844001R1169	1,833.70
20	S804PV-S20	2CCP844001R1209	1,833.70
25	S804PV-S25	2CCP844001R1259	1,833.70
32	S804PV-S32	2CCP844001R1329	1,833.70
40	S804PV-S40	2CCP844001R1409	2,046.80
50	S804PV-S50	2CCP844001R1509	2,046.80
63	S804PV-S63	2CCP844001R1639	2,046.80
80	S804PV-S80	2CCP844001R1809	2,645.00
100	S804PV-S100	2CCP844001R1829	2,645.00
125	S804PV-S125	2CCP844001R1849	2,729.80

S 800 PV-M SWITCH

Function: DC main switch for photovoltaic applications. Safe disconnection of photovoltaic arrays.

Standard: IEC/EN 60947-3

Icw = 1.5kA

Voltage range:

2P : 800 VDC

3P : 1200 VDC

4P : 1200 VDC

2 Poles



Rating	Model	Order Code	List Price (RM)
32	S802PV-M32	2CCP812001R1329	899.00
125	S802PV-M125	2CCP812001R1849	1,644.80

3 Poles

Rating	Model	Order Code	List Price (RM)
32	S803PV-M32	2CCP813001R1329	1,330.90
125	S803PV-M125	2CCP813001R1849	2,466.80

4 Poles

Rating	Model	Order Code	List Price (RM)
32	S804PV-M32	2CCP814001R1329	1,781.80
125	S804PV-M125	2CCP814001R1849	3,308.90

Low Voltage Products Solutions for Solar Energy

E 90 PV Fuse Disconnectors

Standard: IEC/EN 60947-3
Rated service voltage: 1000V
Utilization category: DC-20B
Fuse size: 10.3 x 38 mm



Poles	Rated current (A)	Model	Order Code	List Price (RM)
1P	32	E 91/32 PV	2CSM204713R1801	42.50
	32	E 91/32 PVs	2CSM204693R1801	63.70
2P	32	E 92/32 PV	2CSM204703R1801	91.20
	32	E 92/32 PVs	2CSM256913R1801	140.00

E 9F PV Cylindrical Fuses

Standard: IEC/EN 60269-6
Rated voltage: 1000VDC
Utilization category: gPV
Breaking capacity: 50kA
Minimum breaking capacity : From 1 A up to 7 A = 1.3 x I_n
: From 8 A up to 30 A = 2.0 x I_n

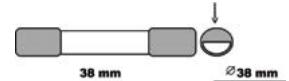

Fuse size: 10.3 x 38 mm

Rated current (A)	Model	Order Code	List Price (RM)
1	E 9F1 PV	2CSM213456R1801	98.40
2	E 9F2 PV	2CSM213466R1801	98.40
3	E 9F3 PV	2CSM213476R1801	98.40
4	E 9F4 PV	2CSM213486R1801	98.40
5	E 9F5 PV	2CSM213496R1801	98.40
6	E 9F6 PV	2CSM213506R1801	98.40
7	E 9F7 PV	2CSM213516R1801	98.40
8	E 9F8 PV	2CSM213526R1801	98.40
10	E 9F10 PV	2CSM213536R1801	98.40
12	E 9F12 PV	2CSM213546R1801	98.40
15	E 9F15 PV	2CSM213556R1801	98.40
20	E 9F20 PV	2CSM213566R1801	98.40
25	E 9F25 PV	2CSM213576R1801	98.40
30	E 9F30 PV	2CSM213586R1801	98.40

Low Voltage Products Solutions for Solar Energy

Surge Protective Devices, Photovoltaic

OVR range: Type 2, PV

Standard: IEC 61643-1, UTE C 61-740-51

Nominal System Voltage Un : 600 / 1000 V DC

Max. cont. operating voltage Ucpv: 670 / 1000



Poles	I _{max} (8/20)	Remote Indicator	Model	Order Code	List Price (RM)
2P	40kA	Yes	OVR PV 40 600 P	2CTB803953R5300	1,053.50
			OVR PV 40 600 P TS	2CTB803953R5400	1,173.10
	40kA	Yes	OVR PV T2 40 1000 P QS	2CTB804153R2400	1,082.30
			OVR PV 40 1000 P TS	2CTB803953R6500	1,237.00

Surge protective devices SPD

OVR range: Type 2, Type 2 + 3

Type 2 : Surge arrester designed to run-off energy caused by an overvoltage comparable to that of an indirect lighting (8/20 wave) Class II

: Surge arresters installed at sub-switch board and distribution board

Full Mode Protection (Common Mode + Differential Mode)

(TT/TN-S)



Type	Poles	I _{max} (8/20)	Model	Order code	List Price (RM)
Type 2	1P+N	80kA	OVR T2 1N 80-275s P QS	2CTB815708R1400	1,406.10
			OVR T2 1N 80-275s P TS QS	2CTB815708R0200	1,654.50
		40kA	OVR T2 1N 40-275 P QS	2CTB803972R1100	633.00
			OVR T2 1N 40-275 P TS QS	2CTB803972R0500	1,082.30
	3P+N	80kA	OVR T2 3N 80-275s P QS	2CTB815708R2000	2,148.20
			OVR T2 3N 80-275s P TS QS	2CTB815708R0800	2,282.20
		40kA	OVR T2 3N 40-275 P QS	2CTB803973R1100	1,053.50
			OVR T2 3N 40-275 P TS QS	2CTB803973R0500	1,173.10
Type 2+3	1P+N	20kA	OVR T2-T3 1N 20-275 P QS	2CTB803972R1200	745.30
			OVR T2-T3 1N 20-275 P TS QS	2CTB803972R1300	1,271.40
	3P+N	20kA	OVR T2-T3 3N 20-275 P QS	2CTB803973R1200	1,334.00
			OVR T2-T3 3N 20-275 P TS QS	2CTB803973R1600	2,276.50

Cartridges

Type	I _{max} (8/20)	Model	Order Code	List Price (RM)
Type 2	80kA	OVR T2 80-275s C QS	2CTB815708R2600	513.40
	40kA	OVR T2 40-275 C QS	2CTB803876R1000	370.20
	80kA (Neutral)	OVR T2 N 80-275s C QS	2CTB815708R2800	916.10
Type 2 + 3	20kA	OVR T2-T3 20-275 C QS	2CTB803876R1200	274.30
	80kA (Neutral)	OVR T2-T3 N 80-275 C QS	2CTB803876R0000	618.40

*QS - Quick Safe Technology

*P - Pluggable Device

*s - Reserved Protection

*TS - Auxiliary contact

*C - Cartridge

***NOTE: All List Prices Excluding 6% GST**

Low Voltage Products Solutions for Solar Energy

OTDC Switch-disconnectors

Technical Description

- Specifically designed for DC use
- Complies with IEC 60947-3
- Rated voltage up to 1500V (please contact us for more info)
- Utilization category: DC 21-B



Up to 1500 VDC	Voltage Rating	Rated current (A)	Type	Order Code	List Price (RM)
2	Up to 660 VDC	16	* OTDC16F2	1SCA121454R1001	323.00
		25	* OTDC25F2	1SCA121455R1001	375.00
		32	* OTDC32F2	1SCA121456R1001	438.00
3	Up to 1000 VDC	16	* OTDC16F3	1SCA121457R1001	424.00
		25	* OTDC25F3	1SCA121458R1001	492.00
		32	* OTDC32F3	1SCA121459R1001	540.00
4	Up to 1200 VDC	16	* OTDC16F4	1SCA121461R1001	608.00
		25	* OTDC25F4	1SCA121462R1001	690.00
		32	* OTDC32F4	1SCA121463R1001	773.00

* Shafts and handles are not included.



Poles	Voltage Rating	Rated current (A)	Type	Order Code	List Price (RM)
2	Up to 1000 VDC	100	* OTDC100E02	1SCA125822R1001	1,978.00
		160	* OTDC160E02	1SCA125840R1001	2,417.00
		200	* OTDC200E02	1SCA123687R1001	2,966.00
		250	* OTDC250E02	1SCA125866R1001	3,515.00
		315	* OTDC315E02	1SCA132337R1001	4,064.00
		400	* OTDC400E02	1SCA132349R1001	4,614.00
		500	* OTDC500E02	1SCA132357R1001	6,591.00

* Shafts and handles are not included.

Shaft & Handle

Poles	Type	Order Code	List Price (RM)
Suitable for switches OTDC16...32F	OX6X130, shaft 130mm length, 6mm diameter	1SCA101655R1001	40.00
	OHBS2AJ1, black handle, IP65	1SCA105215R1001	55.00
Suitable for switches OTDC100...250E	OX6X210, shaft 210mm length, 6mm diameter	1SCA022295R6080	37.00
	OH65J6, black handle, IP65	1SCA022380R9660	232.00
Suitable for switches OTDC315...500E	OX12X185, shaft 185 length, 12mm diameter	1SCA022325R6710	80.00
	OH95J12, black handle, IP65	1SCA022381R0830	360.00

Low Voltage Products Solutions for Marine

A series of horizontal dotted lines for writing.

Low Voltage Products Solutions for Marine

The product range below has been certified with the relevant international marine standards



Model Range

S 200	X	X	X	X	X	X	N/A
S 200 M	X	X	X	X	X	X	N/A
S 200 P	X	N/A	X	X	X	X	N/A
S 8002	X	X	X	X	X	N/A	N/A
Tmax T1-T7	X	X	X	X	X	X	X
Tmax XT	X	X	X	X	X	X	N/A
Emax	X	X	X	X	X	X	X
A9 – A300	X	X	X	X	X	X	N/A
AF400 – AF750	X	X	X	X	N/A	X	N/A
AF1350 – AF1650	N/A	X	X	N/A	N/A	X	N/A
TA25 – TA75	X	X	X	X	N/A	X	N/A
TA80 – TA110	N/A	X	N/A	N/A	N/A	N/A	N/A
TA200 – TA450	X	X	X	X	X	X	N/A
E16 – E800	X	X	X	N/A	X	X	N/A
MS116	X	X	X	N/A	X	X	N/A
MS132	X	X	X	X	X	X	N/A
Softstarter PST/B	N/A	X	N/A	N/A	N/A	N/A	X

Medium Voltage Products Portfolio Solutions

For enquiries and further information
<http://new.abb.com/medium-voltage>
Email: seng-wee.ling@my.abb.com

Distribution Automation

- Feeder Application
- Transformer Application
- Motor Protection
- Generator and Sync Motor Protection
- Distance Protection
- Arc Protection



Primary and Secondary Switchgears

- Unigear Air Insulated Switchgear
- Unigear Gas Insulated Switchgear
- SafeRing/SafePlus Secondary Sv



Apparatus and Components

- Instrument Transformers (Indoor/Outdoor)
- Circuit Breakers and Isolators (Indoor/Outdoor)
- Switches and Disconnectors (Indoor/Outdoor)



Modular Systems

- Compact Substations
- House Solution



Index

Index

Order Code	List price (RM)
1SAM101923R0002	12.90
1SAM201901R1001	50.10
1SAM201902R1001	37.30
1SAM201902R1002	37.30
1SAM201902R1003	37.30
1SAM201903R1001	43.80
1SAM201903R1002	94.80
1SAM201903R1003	94.80
1SAM201904R1001	334.10
1SAM201904R1002	334.10
1SAM201904R1003	334.10
1SAM201904R1004	334.10
1SAM201904R1005	334.10
1SAM201904R1006	334.10
1SAM201904R1007	334.10
1SAM201904R1008	334.10
1SAM201910R1001	221.30
1SAM201910R1002	221.30
1SAM201910R1003	221.30
1SAM201910R1004	221.30
1SAM201920R1001	124.60
1SAM201920R1002	124.60
1SAM201920R1011	138.30
1SAM201920R1012	138.30
1SAM250000R1001	193.40
1SAM250000R1002	193.40
1SAM250000R1003	193.40
1SAM250000R1004	193.40
1SAM250000R1005	193.40
1SAM250000R1006	193.40
1SAM250000R1007	193.40
1SAM250000R1008	193.40
1SAM250000R1009	193.40
1SAM250000R1010	193.40
1SAM250000R1011	233.50
1SAM250000R1012	233.50
1SAM250000R1013	291.10
1SAM250000R1014	310.60
1SAM250000R1015	387.70
1SAM301901R1001	91.60
1SAM301901R1002	91.60
1SAM301901R1003	91.60
1SAM350000R1001	288.90
1SAM350000R1002	288.90
1SAM350000R1003	288.90
1SAM350000R1004	288.90
1SAM350000R1005	315.00
1SAM350000R1006	315.00
1SAM350000R1007	315.00
1SAM350000R1008	315.00

Order Code	List price (RM)
1SAM350000R1009	315.00
1SAM350000R1010	388.60
1SAM350000R1011	388.60
1SAM350000R1012	388.60
1SAM350000R1013	444.00
1SAM350000R1014	499.40
1SAM350000R1015	666.50
1SAM401901R1001	123.50
1SAM401901R1002	123.50
1SAM401902R1001	123.50
1SAM401902R1002	123.50
1SAM401902R1003	123.50
1SAM401904R1001	210.70
1SAM401905R1001	268.20
1SAM401905R1002	268.20
1SAM401905R1003	268.20
1SAM401905R1004	268.20
1SAM401907R1001	268.20
1SAM401907R1002	268.20
1SAM401907R1003	268.20
1SAM401907R1004	268.20
1SAM451000R1011	830.90
1SAM451000R1012	898.90
1SAM451000R1013	991.20
1SAM451000R1014	1,083.50
1SAM451000R1015	1,156.40
1SAM451000R1016	1,341.00
1SAM451000R1017	1,467.30
1SAM550000R1008	1,848.60
1SAM550000R1009	1,960.50
1SAM550000R1010	2,218.90
1SAX101110R0001	117.00
1SAX111001R1101	714.90
1SAX111001R1102	714.90
1SAX111001R1103	714.90
1SAX111001R1104	788.00
1SAX111001R1105	788.00
1SAX121001R1101	604.30
1SAX121001R1102	604.30
1SAX121001R1103	604.30
1SAX121001R1104	678.40
1SAX121001R1105	678.40
1SAX221001R1101	1,062.20
1SAX221001R1102	1,319.10
1SAX331001R1101	1,648.00
1SAX341001R1101	1,743.10
1SAX351001R1101	2,246.70
1SAX531001R1101	2,526.20
1SAX611001R1101	2,856.10
1SAX701902R1001	2,040.50

Index

Order Code	List price (RM)
1SAX701902R1011	2,081.60
1SAX721001R1101	3,478.60
1SAX801902R1001	2,142.80
1SAX801902R1011	2,040.50
1SAX821001R1101	6,223.90
1SAZ201108R0001	96.00
1SAZ201108R0002	131.80
1SAZ211201R2005	114.80
1SAZ211201R2009	114.80
1SAZ211201R2013	114.80
1SAZ211201R2017	114.80
1SAZ211201R2021	114.80
1SAZ211201R2023	114.80
1SAZ211201R2025	114.80
1SAZ211201R2028	114.80
1SAZ211201R2031	114.80
1SAZ211201R2033	114.80
1SAZ211201R2035	114.80
1SAZ211201R2038	114.80
1SAZ211201R2040	114.80
1SAZ211201R2043	114.80
1SAZ211201R2045	114.80
1SAZ211201R2047	140.20
1SAZ211201R2051	151.80
1SAZ211201R2053	183.50
1SAZ301110R0001	229.70
1SAZ311201R2001	198.20
1SAZ311201R2002	223.50
1SAZ311201R2003	226.60
1SAZ321201R2001	323.60
1SAZ321201R2002	323.60
1SAZ321201R2003	323.60
1SAZ321201R2004	416.20
1SAZ321201R2005	416.20
1SAZ321201R2006	416.20
1SAZ331201R1003	366.70
1SAZ331201R1004	476.40
1SAZ331201R1005	476.40
1SAZ331201R1006	494.60
1SAZ401110R0001	229.70
1SAZ411201R1001	531.20
1SAZ411201R1002	586.10
1SAZ421201R1001	985.80
1SAZ421201R1002	985.80
1SAZ421201R1003	985.80
1SAZ421201R1004	985.80
1SAZ421201R1005	985.80
1SAZ421201R1006	985.80
1SAZ711201R1005	129.10
1SAZ711201R1008	129.10

Order Code	List price (RM)
1SAZ711201R1009	129.10
1SAZ711201R1013	129.10
1SAZ711201R1014	129.10
1SAZ711201R1017	129.10
1SAZ711201R1021	129.10
1SAZ711201R1023	129.10
1SAZ711201R1025	129.10
1SAZ711201R1028	129.10
1SAZ711201R1031	129.10
1SAZ711201R1033	129.10
1SAZ711201R1035	129.10
1SAZ711201R1038	129.10
1SAZ711201R1040	129.10
1SAZ711201R1043	129.10
1SAZ711201R1045	129.10
1SAZ711201R1047	139.80
1SAZ721201R1005	154.90
1SAZ721201R1008	154.90
1SAZ721201R1009	154.90
1SAZ721201R1013	154.90
1SAZ721201R1014	154.90
1SAZ721201R1017	154.90
1SAZ721201R1021	154.90
1SAZ721201R1023	154.90
1SAZ721201R1025	154.90
1SAZ721201R1028	154.90
1SAZ721201R1031	154.90
1SAZ721201R1033	154.90
1SAZ721201R1035	154.90
1SAZ721201R1038	154.90
1SAZ721201R1040	154.90
1SAZ721201R1043	154.90
1SAZ721201R1045	176.40
1SAZ721201R1047	176.40
1SAZ721201R1049	176.40
1SAZ721201R1051	216.30
1SAZ721201R1052	252.70
1SAZ721201R1053	264.50
1SAZ721201R1055	264.50
1SBH137001R1222	261.50
1SBH137001R1231	261.50
1SBH137001R1240	261.50
1SBH137001R1244	342.00
1SBH137001R1253	342.00
1SBH137001R1262	342.00
1SBH137001R1271	342.00
1SBH137001R1280	342.00
1SBH137001R1322	261.50
1SBH137001R1331	261.50
1SBH137001R1340	261.50

Index

Order Code	List price (RM)
1SBH137001R1344	342.00
1SBH137001R1353	342.00
1SBH137001R1362	342.00
1SBH137001R1371	342.00
1SBH137001R1380	342.00
1SBH137001R1422	261.50
1SBH137001R1431	261.50
1SBH137001R1440	261.50
1SBH137001R1444	342.00
1SBH137001R1453	342.00
1SBH137001R1462	342.00
1SBH137001R1471	342.00
1SBH137001R1480	342.00
1SBH137001R4122	261.50
1SBH137001R4131	261.50
1SBH137001R4140	261.50
1SBH137001R4144	342.00
1SBH137001R4153	342.00
1SBH137001R4162	342.00
1SBH137001R4171	342.00
1SBH137001R4180	342.00
1SBH141001R..44	228.10
1SBH141001R..53	228.10
1SBH141001R..62	228.10
1SBH141001R..71	228.10
1SBH141001R..80	228.10
1SBH901074R..22	124.90
1SBH901074R..31	124.90
1SBH901074R..40	124.90
1SBL137001R1101	133.90
1SBL137001R1110	133.90
1SBL137001R1201	133.90
1SBL137001R1210	133.90
1SBL137001R1301	133.90
1SBL137001R1310	133.90
1SBL137001R1401	133.90
1SBL137001R1410	133.90
1SBL137201R1100	216.10
1SBL137201R1200	216.10
1SBL137201R1300	216.10
1SBL137201R1400	216.10
1SBL137501R1100	244.60
1SBL137501R1200	244.60
1SBL137501R1300	244.60
1SBL137501R1400	244.60
1SBL157001R1101	172.90
1SBL157001R1110	172.90
1SBL157001R1201	172.90
1SBL157001R1210	172.90
1SBL157001R1301	172.90

Order Code	List price (RM)
1SBL157001R1310	172.90
1SBL157001R1401	172.90
1SBL157001R1410	172.90
1SBL177001R1101	225.60
1SBL177001R1110	225.60
1SBL177001R1201	225.60
1SBL177001R1210	225.60
1SBL177001R1301	225.60
1SBL177001R1310	225.60
1SBL177001R1401	225.60
1SBL177001R1410	225.60
1SBL177201R1100	316.20
1SBL177201R1200	316.20
1SBL177201R1300	316.20
1SBL177201R1400	316.20
1SBL177501R1100	352.00
1SBL177501R1200	352.00
1SBL177501R1300	352.00
1SBL177501R1400	352.00
1SBL181022R..10	235.60
1SBL181024R..10	443.10
1SBL237001R1111	295.10
1SBL237001R1211	295.10
1SBL237001R1311	295.10
1SBL237001R1411	295.10
1SBL237201R1100	423.70
1SBL237201R1200	423.70
1SBL237201R1300	423.70
1SBL237201R1400	423.70
1SBL237501R1100	459.30
1SBL237501R1200	459.30
1SBL237501R1300	459.30
1SBL237501R1400	459.30
1SBL241022R..10	341.90
1SBL241024R..10	566.70
1SBL277001R1111	377.20
1SBL277001R1211	377.20
1SBL277001R1311	377.20
1SBL277001R1411	377.20
1SBL281022R..10	500.00
1SBL281024R..10	856.90
1SBL281074R..01	251.80
1SBL281074R..10	251.80
1SBL297001R1111	493.10
1SBL297001R1211	493.10
1SBL297001R1311	493.10
1SBL297001R1411	493.10
1SBL297201R1100	718.60
1SBL297201R1200	718.60
1SBL297201R1300	718.60

Index

Order Code	List price (RM)
1SBL297201R1400	718.60
1SBL297501R1100	1,069.30
1SBL297501R1200	1,069.30
1SBL297501R1300	1,069.30
1SBL297501R1400	1,069.30
1SBL321074R..01	305.30
1SBL321074R..10	305.30
1SBL337201R6900	1,770.60
1SBL337201R7000	1,770.60
1SBL337201R7200	1,770.60
1SBL337501R6900	2,541.30
1SBL337501R7000	2,541.30
1SBL337501R7200	2,541.30
1SBL347001R1111	547.80
1SBL347001R1211	547.80
1SBL347001R1311	547.80
1SBL347001R1411	547.80
1SBL351022R..11	537.70
1SBL351024R..00	916.00
1SBL351074R..11	460.40
1SBL357201R6900	1,643.80
1SBL357201R7000	1,643.80
1SBL357201R7200	1,643.80
1SBL367001R1111	1,048.10
1SBL367001R1211	1,048.10
1SBL367001R1311	1,048.10
1SBL367001R1411	1,048.10
1SBL371022R..11	681.80
1SBL371024R..00	938.50
1SBL371074R..11	680.60
1SBL387001R1111	1,128.90
1SBL387001R1211	1,128.90
1SBL387001R1311	1,128.90
1SBL387001R1411	1,128.90
1SBL397001R1111	1,180.40
1SBL397001R1211	1,180.40
1SBL397001R1311	1,180.40
1SBL397001R1411	1,180.40
1SBL407001R1111	1,870.50
1SBL407001R1211	1,870.50
1SBL407001R1311	1,870.50
1SBL407001R1411	1,870.50
1SBL411022R..11	767.60
1SBL411024R..00	1,033.20
1SBL411074R..11	700.60
1SBL417201R6900	1,850.10
1SBL417201R7000	1,850.10
1SBL417201R7200	1,850.10
1SBL417501R6900	3,011.00
1SBL417501R7000	3,011.00

Order Code	List price (RM)
1SBL417501R7200	3,011.00
1SBL901074R..01	90.50
1SBL901074R..10	90.50
1SBL911074R..01	108.70
1SBL911074R..10	108.70
1SBL921074R..01	136.80
1SBL921074R..10	136.80
1SBL931074R..01	194.70
1SBL931074R..10	194.70
1SBN010110R1001	23.30
1SBN010110R1010	23.30
1SBN010120R1011	52.80
1SBN010140R1004	94.80
1SBN010140R1022	94.80
1SBN010140R1040	94.80
1SBN010140R1104	94.80
1SBN010140R1122	94.80
1SBN010140R1322	94.80
1SBN010140R1340	94.80
1SBN019010R1001	19.00
1SBN019010R1010	19.00
1SBN019020R1011	47.50
1SBN019040R1004	94.80
1SBN019040R1022	94.80
1SBN019040R1040	94.80
1SBN019040R1104	94.80
1SBN019040R1122	94.80
1SBN019040R1322	94.80
1SBN019040R1340	94.80
1SBN020010R1001	410.90
1SBN020010R1002	410.90
1SBN020010R1003	410.90
1SBN020010R1004	601.70
1SBN020112R1000	348.40
1SBN020114R1000	348.40
1SBN020312R1000	348.40
1SBN020314R1000	348.40
1SBN030100R1000	108.60
1SBN030105T1000	47.50
1SBN030110R1000	84.40
1SBN030111R1000	108.60
1SBN030210R1000	113.90
1SBN081306T1000	48.50
1SBN081406R1000	54.80
1SBN082306T1000	48.50
1SBN082306T2000	48.50
1SBN083206R1000	128.60
1SBN083506R1000	147.60
1SBN084106R1000	245.60
1SBN084506R1000	418.30

Index

Order Code	List price (RM)
1SBN089306T1000	64.30
1SBN089306T1001	64.30
1SCA022190R3000	69.00
1SCA022190R3260	69.00
1SCA022259R7410	68.00
1SCA022295R6080	37.00
1SCA022325R6710	80.00
1SCA022353R4890	69.00
1SCA022353R4970	69.00
1SCA022380R9660	232.00
1SCA022381R0830	360.00
1SCA022456R7410	69.00
1SCA022627R0230	45.00
1SCA022627R0310	45.00
1SCA022627R0400	45.00
1SCA022627R0580	45.00
1SCA022627R0660	45.00
1SCA022627R0740	45.00
1SCA022627R0820	45.00
1SCA022627R0910	45.00
1SCA022627R1040	45.00
1SCA022627R1120	45.00
1SCA022627R1210	45.00
1SCA022627R1390	45.00
1SCA022627R1470	45.00
1SCA022627R1550	45.00
1SCA022627R1630	87.00
1SCA022627R1710	87.00
1SCA022627R4490	102.00
1SCA022627R4650	102.00
1SCA022627R5970	153.00
1SCA022627R6010	153.00
1SCA022627R6190	153.00
1SCA022627R6270	240.00
1SCA022627R7080	260.00
1SCA022627R7160	260.00
1SCA022627R7240	446.00
1SCA022627R7750	1,161.00
1SCA022627R7830	1,295.00
1SCA022629R5140	91.00
1SCA022629R5220	91.00
1SCA022629R5310	91.00
1SCA022710R0100	1,094.00
1SCA022710R0520	1,283.00
1SCA022712R0800	987.00
1SCA022713R4930	1,144.00
1SCA022714R8810	67.00
1SCA022718R8510	1,350.00
1SCA022718R8780	1,749.00
1SCA022718R8940	2,398.00

Order Code	List price (RM)
1SCA022718R9410	3,747.00
1SCA022719R1730	1,648.00
1SCA022719R1810	2,169.00
1SCA022719R2030	3,063.00
1SCA022719R2110	4,494.00
1SCA022721R3050	1,972.00
1SCA022721R3130	2,773.00
1SCA022726R8380	2,564.00
1SCA022726R8460	3,903.00
1SCA022735R9420	220.00
1SCA022749R1960	280.00
1SCA022753R1770	5,914.00
1SCA022753R3800	4,455.00
1SCA022771R7280	2,548.00
1SCA022771R8680	4,045.00
1SCA022775R4640	3,063.00
1SCA022775R7150	3,823.00
1SCA022775R9440	2,398.00
1SCA022785R6130	5,243.00
1SCA022785R6210	7,864.00
1SCA022807R5100	560.00
1SCA022825R3810	7,017.00
1SCA022825R4450	9,459.00
1SCA022825R5340	11,825.00
1SCA022825R5510	15,765.00
1SCA022846R1590	8,343.00
1SCA022846R1910	9,014.00
1SCA022847R2870	9,999.00
1SCA022847R3250	11,142.00
1SCA022848R1510	7,043.00
1SCA022860R5930	5,475.00
1SCA022860R6150	5,992.00
1SCA022860R6230	6,123.00
1SCA022860R6310	6,741.00
1SCA022860R6580	9,024.00
1SCA022860R6740	10,111.00
1SCA022872R1250	12,356.00
1SCA022872R1500	11,607.00
1SCA022872R2310	18,533.00
1SCA022872R8340	23,792.00
1SCA022873R1990	16,008.00
1SCA100431R1001	2,181.00
1SCA101655R1001	40.00
1SCA101659R1001	45.00
1SCA103765R1001	1,785.00
1SCA103906R1001	33,323.00
1SCA103912R1001	31,283.00
1SCA104811R1001	112.00
1SCA104829R1001	153.00
1SCA104831R1001	583.00

Index

Order Code	List price (RM)
1SCA104857R1001	112.00
1SCA104877R1001	660.00
1SCA104886R1001	153.00
1SCA104902R1001	128.00
1SCA104932R1001	185.00
1SCA104934R1001	747.00
1SCA104972R1001	14,266.00
1SCA105001R1001	83.00
1SCA105004R1001	296.00
1SCA105018R1001	461.00
1SCA105019R1001	1,381.00
1SCA105033R1001	366.00
1SCA105051R1001	500.00
1SCA105054R1001	1,559.00
1SCA105099R1001	172.00
1SCA105140R1001	17,410.00
1SCA105215R1001	55.00
1SCA105220R1001	80.00
1SCA105246R1001	17,538.00
1SCA105332R1001	181.00
1SCA105365R1001	271.00
1SCA105369R1001	1,160.00
1SCA105413R1001	319.00
1SCA105418R1001	1,249.00
1SCA105461R1001	110.00
1SCA105798R1001	241.00
1SCA107931R1001	4,326.00
1SCA107933R1001	23,252.00
1SCA108036R1001	11,982.00
1SCA108038R1001	13,480.00
1SCA112702R1001	28,738.00
1SCA112703R1001	26,938.00
1SCA112704R1001	38,471.00
1SCA112712R1001	52,602.00
1SCA112713R1001	61,684.00
1SCA114581R1001	1,085.00
1SCA115202R1001	1,519.00
1SCA115227R1001	1,085.00
1SCA115230R1001	1,519.00
1SCA115641R1001	1,085.00
1SCA115643R1001	1,578.00
1SCA115880R1001	1,519.00
1SCA115884R1001	1,972.00
1SCA116892R1001	1,293.00
1SCA120097R1001	5,877.00
1SCA120098R1001	4,888.00
1SCA120100R1001	4,636.00
1SCA120101R1001	4,216.00
1SCA120102R1001	3,794.00
1SCA120514R1001	632.00

Order Code	List price (RM)
1SCA120521R1001	869.00
1SCA121454R1001	323.00
1SCA121455R1001	375.00
1SCA121456R1001	438.00
1SCA121457R1001	424.00
1SCA121458R1001	492.00
1SCA121459R1001	540.00
1SCA121461R1001	608.00
1SCA121462R1001	690.00
1SCA121463R1001	773.00
1SCA122306R1001	476.00
1SCA123687R1001	2,966.00
1SCA124848R1001	40,140.00
1SCA124856R1001	47,533.00
1SCA125822R1001	1,978.00
1SCA125840R1001	2,417.00
1SCA125866R1001	3,515.00
1SCA128175R1001	242.00
1SCA128481R1001	28,391.00
1SCA128482R1001	34,859.00
1SCA128807R1001	7,000.00
1SCA129158R1001	66,537.00
1SCA132337R1001	4,064.00
1SCA132349R1001	4,614.00
1SCA132357R1001	6,591.00
1SDA013954R1	748.00
1SDA013955R1	971.00
1SDA038320R1	1,197.00
1SDA054117R1	2,212.00
1SDA054121R1	3,846.00
1SDA054125R1	2,384.00
1SDA054129R1	4,806.00
1SDA054133R1	2,577.00
1SDA054137R1	4,806.00
1SDA054317R1	2,424.00
1SDA054325R1	4,612.00
1SDA054333R1	2,636.00
1SDA054341R1	4,999.00
1SDA054349R1	2,827.00
1SDA054357R1	5,722.00
1SDA054396R1	3,807.00
1SDA054400R1	6,150.00
1SDA054404R1	4,230.00
1SDA054408R1	7,304.00
1SDA054412R1	4,806.00
1SDA054416R1	8,457.00
1SDA054456R1	3,461.00
1SDA054461R1	3,846.00
1SDA054465R1	4,536.00
1SDA054487R1	5,767.00

Index

Order Code	List price (RM)
1SDA054489R1	6,920.00
1SDA054491R1	8,072.00
1SDA054873R1	346.00
1SDA054874R1	346.00
1SDA054891R1	473.00
1SDA054892R1	473.00
1SDA054897R1	5,362.00
1SDA054904R1	418.00
1SDA054905R1	418.00
1SDA054910R1	365.00
1SDA054911R1	618.00
1SDA054926R1	382.00
1SDA054929R1	494.00
1SDA054939R1	418.00
1SDA054940R1	418.00
1SDA054944R1	425.00
1SDA054946R1	876.00
1SDA054947R1	876.00
1SDA054948R1	361.00
1SDA054949R1	361.00
1SDA054950R1	361.00
1SDA054951R1	361.00
1SDA054952R1	361.00
1SDA054953R1	361.00
1SDA054954R1	6,160.00
1SDA054955R1	9,058.00
1SDA055002R1	211.00
1SDA055003R1	288.00
1SDA055034R1	266.00
1SDA055035R1	353.00
1SDA055038R1	356.00
1SDA055039R1	468.00
1SDA060268R1	4,806.00
1SDA060273R1	7,689.00
1SDA060278R1	5,305.00
1SDA060283R1	8,457.00
1SDA060289R1	7,688.00
1SDA060294R1	10,300.00
1SDA060398R1	7,609.00
1SDA060405R1	563.00
1SDA060409R1	762.00
1SDA060417R1	552.00
1SDA060566R1	14,604.00
1SDA060611R1	480.00
1SDA060612R1	480.00
1SDA060658R1	480.00
1SDA060659R1	480.00
1SDA060685R1	3,443.00
1SDA060686R1	3,443.00
1SDA062071R1	782.00

Order Code	List price (RM)
1SDA062072R1	782.00
1SDA062082R1	782.00
1SDA062083R1	782.00
1SDA062093R1	654.00
1SDA062094R1	654.00
1SDA062102R1	726.00
1SDA062104R1	726.00
1SDA062116R1	7,609.00
1SDA062120R1	799.00
1SDA062122R1	907.00
1SDA062134R1	401.00
1SDA062135R1	401.00
1SDA062141R1	401.00
1SDA062142R1	401.00
1SDA062150R1	292.00
1SDA062151R1	292.00
1SDA062160R1	365.00
1SDA062866R1	11,224.00
1SDA062874R1	14,604.00
1SDA062882R1	11,955.00
1SDA062890R1	17,026.00
1SDA062898R1	12,684.00
1SDA062906R1	16,718.00
1SDA062914R1	13,403.00
1SDA062922R1	19,923.00
1SDA062994R1	14,682.00
1SDA063002R1	22,674.00
1SDA063010R1	15,758.00
1SDA063018R1	25,355.00
1SDA063026R1	16,066.00
1SDA063034R1	24,978.00
1SDA063042R1	17,387.00
1SDA063050R1	30,066.00
1SDA063105R1	1,233.00
1SDA063106R1	1,607.00
1SDA063548R1	782.00
1SDA063550R1	782.00
1SDA063552R1	654.00
1SDA063555R1	509.00
1SDA063556R1	509.00
1SDA064321R1	Included
1SDA064322R1	Included
1SDA065523R1	8,594.00
1SDA065524R1	19,203.00
1SDA066137R1	142.00
1SDA066147R1	254.00
1SDA066149R1	318.00
1SDA066150R1	336.00
1SDA066151R1	184.00
1SDA066152R1	227.00

Index

Order Code	List price (RM)
1SDA066154R1	128.00
1SDA066155R1	149.00
1SDA066158R1	149.00
1SDA066159R1	216.00
1SDA066216R1	70.00
1SDA066217R1	94.00
1SDA066222R1	77.00
1SDA066223R1	103.00
1SDA066276R1	272.00
1SDA066277R1	365.00
1SDA066278R1	305.00
1SDA066279R1	324.00
1SDA066282R1	426.00
1SDA066283R1	454.00
1SDA066325R1	248.00
1SDA066326R1	248.00
1SDA066399R1	401.00
1SDA066400R1	401.00
1SDA066431R1	274.00
1SDA066433R1	365.00
1SDA066460R1	2,349.00
1SDA066466R1	2,349.00
1SDA066475R1	227.00
1SDA066479R1	274.00
1SDA066497R1	261.00
1SDA066498R1	261.00
1SDA066500R1	261.00
1SDA066501R1	261.00
1SDA066504R1	261.00
1SDA066506R1	261.00
1SDA066511R1	272.00
1SDA066512R1	272.00
1SDA066514R1	272.00
1SDA066515R1	272.00
1SDA066518R1	272.00
1SDA066520R1	272.00
1SDA066525R1	375.00
1SDA066526R1	375.00
1SDA066528R1	375.00
1SDA066529R1	375.00
1SDA066532R1	375.00
1SDA066534R1	375.00
1SDA066542R1	535.00
1SDA066543R1	535.00
1SDA066545R1	824.00
1SDA066547R1	860.00
1SDA066548R1	443.00
1SDA066549R1	443.00
1SDA066551R1	559.00
1SDA066553R1	621.00

Order Code	List price (RM)
1SDA066554R1	597.00
1SDA066555R1	597.00
1SDA066557R1	765.00
1SDA066559R1	827.00
1SDA066560R1	1,739.00
1SDA066561R1	1,739.00
1SDA066562R1	1,905.00
1SDA066563R1	1,905.00
1SDA066564R1	2,005.00
1SDA066565R1	2,634.00
1SDA066566R1	2,507.00
1SDA066567R1	2,941.00
1SDA066568R1	2,048.00
1SDA066569R1	2,048.00
1SDA066570R1	2,214.00
1SDA066571R1	2,214.00
1SDA066572R1	2,314.00
1SDA066573R1	2,943.00
1SDA066574R1	2,816.00
1SDA066575R1	3,250.00
1SDA066588R1	219.00
1SDA066591R1	255.00
1SDA066592R1	255.00
1SDA066593R1	401.00
1SDA066594R1	401.00
1SDA066599R1	401.00
1SDA066600R1	401.00
1SDA066617R1	401.00
1SDA066618R1	401.00
1SDA066623R1	401.00
1SDA066624R1	401.00
1SDA066629R1	401.00
1SDA066630R1	401.00
1SDA066637R1	876.00
1SDA066638R1	876.00
1SDA066639R1	361.00
1SDA066641R1	361.00
1SDA066645R1	361.00
1SDA066686R1	240.00
1SDA066687R1	240.00
1SDA066689R1	240.00
1SDA066690R1	240.00
1SDA066693R1	240.00
1SDA066695R1	240.00
1SDA066698R1	313.00
1SDA066699R1	313.00
1SDA066701R1	313.00
1SDA066702R1	313.00
1SDA066705R1	313.00
1SDA066707R1	313.00

Index

Order Code	List price (RM)
1SDA066710R1	354.00
1SDA066711R1	354.00
1SDA066713R1	354.00
1SDA066714R1	354.00
1SDA066717R1	354.00
1SDA066719R1	354.00
1SDA066722R1	395.00
1SDA066723R1	395.00
1SDA066725R1	395.00
1SDA066726R1	395.00
1SDA066729R1	395.00
1SDA066731R1	395.00
1SDA066734R1	416.00
1SDA066735R1	416.00
1SDA066737R1	416.00
1SDA066738R1	416.00
1SDA066741R1	416.00
1SDA066743R1	416.00
1SDA066746R1	457.00
1SDA066747R1	457.00
1SDA066749R1	457.00
1SDA066750R1	457.00
1SDA066753R1	457.00
1SDA066755R1	457.00
1SDA066758R1	498.00
1SDA066759R1	498.00
1SDA066761R1	498.00
1SDA066762R1	498.00
1SDA066765R1	498.00
1SDA066767R1	498.00
1SDA066769R1	492.00
1SDA066770R1	492.00
1SDA066772R1	739.00
1SDA066774R1	775.00
1SDA066775R1	613.00
1SDA066776R1	613.00
1SDA066778R1	847.00
1SDA066780R1	970.00
1SDA066781R1	669.00
1SDA066782R1	669.00
1SDA066784R1	976.00
1SDA066786R1	1,010.00
1SDA066787R1	767.00
1SDA066788R1	767.00
1SDA066790R1	1,053.00
1SDA066792R1	1,176.00
1SDA066793R1	824.00
1SDA066794R1	824.00
1SDA066796R1	1,182.00
1SDA066798R1	1,216.00

Order Code	List price (RM)
1SDA066799R1	449.00
1SDA066800R1	449.00
1SDA066801R1	449.00
1SDA066802R1	449.00
1SDA066803R1	449.00
1SDA066804R1	449.00
1SDA066805R1	449.00
1SDA066806R1	449.00
1SDA066807R1	449.00
1SDA066808R1	495.00
1SDA066809R1	778.00
1SDA066810R1	695.00
1SDA066811R1	695.00
1SDA066812R1	695.00
1SDA066813R1	695.00
1SDA066814R1	695.00
1SDA066815R1	695.00
1SDA066816R1	695.00
1SDA066817R1	695.00
1SDA066818R1	695.00
1SDA066821R1	1,011.00
1SDA066867R1	164.00
1SDA066868R1	213.00
1SDA066871R1	130.00
1SDA066872R1	174.00
1SDA066888R1	751.00
1SDA066903R1	211.00
1SDA066904R1	288.00
1SDA067010R1	763.00
1SDA067011R1	763.00
1SDA067012R1	763.00
1SDA067013R1	763.00
1SDA067014R1	763.00
1SDA067015R1	763.00
1SDA067016R1	763.00
1SDA067017R1	763.00
1SDA067018R1	763.00
1SDA067019R1	868.00
1SDA067020R1	1,099.00
1SDA067031R1	1,244.00
1SDA067032R1	1,244.00
1SDA067033R1	1,244.00
1SDA067034R1	1,244.00
1SDA067035R1	1,244.00
1SDA067036R1	1,244.00
1SDA067037R1	1,244.00
1SDA067038R1	1,244.00
1SDA067039R1	1,244.00
1SDA067042R1	1,301.00
1SDA067043R1	1,667.00

Index

Order Code	List price (RM)
1SDA067123R1	1,904.00
1SDA067125R1	2,285.00
1SDA067126R1	3,111.00
1SDA067131R1	5,981.00
1SDA067391R1	534.00
1SDA067392R1	534.00
1SDA067393R1	534.00
1SDA067394R1	534.00
1SDA067395R1	534.00
1SDA067396R1	534.00
1SDA067397R1	534.00
1SDA067398R1	686.00
1SDA067399R1	1,001.00
1SDA067400R1	880.00
1SDA067401R1	880.00
1SDA067402R1	880.00
1SDA067403R1	880.00
1SDA067404R1	880.00
1SDA067405R1	880.00
1SDA067406R1	880.00
1SDA067409R1	918.00
1SDA067410R1	1,302.00
1SDA067550R1	859.00
1SDA067551R1	859.00
1SDA067552R1	859.00
1SDA067553R1	859.00
1SDA067554R1	859.00
1SDA067555R1	859.00
1SDA067556R1	859.00
1SDA067557R1	859.00
1SDA067558R1	859.00
1SDA067559R1	963.00
1SDA067560R1	1,140.00
1SDA067571R1	1,321.00
1SDA067572R1	1,321.00
1SDA067573R1	1,321.00
1SDA067574R1	1,321.00
1SDA067575R1	1,321.00
1SDA067576R1	1,321.00
1SDA067577R1	1,321.00
1SDA067578R1	1,321.00
1SDA067579R1	1,321.00
1SDA067582R1	1,540.00
1SDA067583R1	1,771.00
1SDA067594R1	994.00
1SDA067595R1	994.00
1SDA067596R1	994.00
1SDA067597R1	994.00
1SDA067598R1	994.00
1SDA067599R1	994.00

Order Code	List price (RM)
1SDA067600R1	994.00
1SDA067601R1	994.00
1SDA067602R1	994.00
1SDA067603R1	994.00
1SDA067604R1	1,156.00
1SDA067615R1	1,492.00
1SDA067616R1	1,492.00
1SDA067617R1	1,492.00
1SDA067618R1	1,492.00
1SDA067619R1	1,492.00
1SDA067620R1	1,492.00
1SDA067621R1	1,492.00
1SDA067622R1	1,492.00
1SDA067623R1	1,492.00
1SDA067626R1	1,724.00
1SDA067627R1	2,077.00
1SDA068090R1	1,394.00
1SDA068092R1	1,394.00
1SDA068109R1	2,031.00
1SDA068111R1	2,031.00
1SDA068183R1	581.00
1SDA068185R1	780.00
1SDA068187R1	617.00
1SDA068190R1	802.00
1SDA068196R1	849.00
1SDA068198R1	1,103.00
1SDA068310R1	1,565.00
1SDA068312R1	1,565.00
1SDA068329R1	2,241.00
1SDA068331R1	2,241.00
1SDA068343R1	1,617.00
1SDA068345R1	1,617.00
1SDA068362R1	2,808.00
1SDA068364R1	2,808.00
1SDA068746R1	272.00
1SDA068747R1	313.00
1SDA068748R1	354.00
1SDA068749R1	395.00
1SDA068750R1	375.00
1SDA068751R1	416.00
1SDA068752R1	457.00
1SDA068753R1	498.00
1SDA068755R1	240.00
1SDA068756R1	261.00
1SDA068757R1	272.00
1SDA068758R1	313.00
1SDA068759R1	354.00
1SDA068760R1	395.00
1SDA068761R1	375.00
1SDA068762R1	416.00

Index

Order Code	List price (RM)
1SDA068763R1	457.00
1SDA068764R1	498.00
1SDA068766R1	240.00
1SDA068767R1	261.00
1SDA068768R1	272.00
1SDA068769R1	313.00
1SDA068770R1	354.00
1SDA068771R1	395.00
1SDA068772R1	375.00
1SDA068773R1	416.00
1SDA068774R1	457.00
1SDA068775R1	498.00
1SDA068790R1	261.00
1SDA069053R1	227.00
1SDA069055R1	274.00
1SDA070891R1	17,193.00
1SDA070921R1	17,799.00
1SDA070951R1	18,779.00
1SDA070991R1	20,116.00
1SDA071031R1	27,473.00
1SDA071061R1	33,481.00
1SDA071141R1	40,379.00
1SDA071191R1	49,570.00
1SDA071261R1	115,359.00
1SDA071291R1	158,733.00
1SDA071521R1	19,855.00
1SDA071551R1	20,463.00
1SDA071581R1	21,822.00
1SDA071621R1	22,778.00
1SDA071661R1	29,115.00
1SDA071691R1	35,522.00
1SDA071771R1	42,929.00
1SDA071821R1	57,226.00
1SDA071981R1	134,477.00
1SDA072011R1	180,689.00
1SDA072241R1+1SDA073909R1	19,855.00
1SDA072271R1+1SDA073909R1	20,463.00
1SDA072301R1+1SDA073909R1	21,822.00
1SDA072341R1+1SDA073909R1	22,778.00
1SDA072381R1+1SDA073909R1	31,463.00
1SDA072411R1+1SDA073911R1	36,544.00
1SDA072491R1+1SDA073913R1	42,929.00
1SDA072541R1+1SDA073915R1	48,675.00
1SDA072611R1+1SDA073917R1	130,379.00
1SDA072641R1+1SDA073920R1	167,976.00
1SDA072871R1+1SDA073910R1	22,666.00
1SDA072901R1+1SDA073910R1	22,882.00
1SDA072931R1+1SDA073910R1	25,547.00
1SDA072971R1+1SDA073910R1	26,639.00
1SDA073011R1+1SDA073910R1	35,721.00

Order Code	List price (RM)
1SDA073041R1+1SDA073912R1	41,434.00
1SDA073121R1+1SDA073914R1	49,692.00
1SDA073171R1+1SDA073916R1	66,575.00
1SDA073331R1+1SDA073919R1	158,000.00
1SDA073361R1+1SDA073922R1	199,025.00
1SDA073402R1	11,639.00
1SDA073404R1	12,228.00
1SDA073406R1	13,179.00
1SDA073409R1	14,478.00
1SDA073412R1	21,621.00
1SDA073414R1	27,454.00
1SDA073418R1	34,151.00
1SDA073421R1	43,073.00
1SDA073426R1	110,306.00
1SDA073428R1	153,681.00
1SDA073441R1	14,224.00
1SDA073443R1	14,813.00
1SDA073445R1	16,134.00
1SDA073448R1	17,062.00
1SDA073451R1	23,213.00
1SDA073453R1	29,435.00
1SDA073457R1	36,627.00
1SDA073460R1	50,433.00
1SDA073471R1	129,425.00
1SDA073473R1	175,637.00
1SDA073510R1+1SDA073917R1	125,327.00
1SDA073512R1+1SDA073920R1	162,924.00
1SDA073557R1+1SDA073922R1	193,973.00
1SDA073555R1+1SDA073919R1	152,948.00
1SDA073675R1	890.00
1SDA073688R1	890.00
1SDA073704R1	1,197.00
1SDA073725R1	5,392.00
1SDA073781R1	437.00
1SDA073791R1	546.00
1SDA073792R1	546.00
1SDA073803R1	355.00
1SDA073804R1	355.00
1SDA073805R1	355.00
1SDA073867R1	1,792.00
1SDA073869R1	1,792.00
1SDA073881R1	1,545.00
1SDA073882R1	1,545.00
1SDA073885R1	1,545.00
1SDA073886R1	1,545.00
1SDA073889R1	773.00
1SDA073890R1	773.00
1SDA073891R1	773.00
1SDA073892R1	773.00
1SDA073895R1	979.00

Index

Order Code	List price (RM)
1SDA073897R1	979.00
1SDA076166R1	199.00
1SDA076167R1	285.00
1SDA076168R1	199.00
1SDA076169R1	285.00
1SDA076855R1	8,955.00
1SDA076864R1	10,186.00
1SDA076877R1	12,990.00
1SDA082157R1+1SDA073909R1	14,224.00
1SDA082158R1+1SDA073909R1	14,813.00
1SDA082159R1+1SDA073909R1	16,134.00
1SDA082160R1+1SDA073909R1	17,062.00
1SDA082161R1+1SDA073909R1	25,495.00
1SDA082162R1+1SDA073911R1	30,427.00
1SDA082163R1+1SDA073913R1	36,627.00
1SDA082164R1+1SDA073915R1	42,204.00
1SDA082165R1+1SDA073910R1	16,953.00
1SDA082171R1+1SDA073910R1	17,163.00
1SDA082172R1+1SDA073910R1	19,749.00
1SDA082173R1+1SDA073910R1	20,810.00
1SDA082174R1+1SDA073910R1	29,628.00
1SDA082175R1+1SDA073912R1	35,174.00
1SDA082176R1+1SDA073914R1	43,193.00
1SDA082177R1+1SDA073916R1	54,330.00
1SEP101890R0002	459.00
1SEP101891R0002	1,307.00
1SEP101892R0002	1,756.00
1SEP101975R0002	3,395.00
1SEP201428R0001	333.00
1SEP600115R0002	919.00
1SEP600119R0002	3,354.00
1SEP600124R0002	4,670.00
1SEP600128R0002	6,274.00
1SFA611100R1001	14.60
1SFA611100R1002	14.60
1SFA611100R1003	14.60
1SFA611100R1004	14.60
1SFA611100R1005	14.60
1SFA611100R1006	14.60
1SFA611100R1008	14.60
1SFA611100R1101	55.10
1SFA611100R1102	55.10
1SFA611100R1103	55.10
1SFA611100R1104	55.10
1SFA611100R1105	55.10
1SFA611124R1001	57.20
1SFA611201R1006	27.50
1SFA611210R1006	27.50
1SFA611211R1006	33.70
1SFA611280R1001	78.60

Order Code	List price (RM)
1SFA611281R1001	78.60
1SFA611282R1001	84.80
1SFA611283R1001	109.20
1SFA611284R1001	109.20
1SFA611300R1006	64.30
1SFA611301R1006	68.40
1SFA611302R1006	68.40
1SFA611400R1001	10.20
1SFA611400R1002	10.20
1SFA611400R1003	10.20
1SFA611400R1004	10.20
1SFA611400R1005	10.20
1SFA611510R1001	69.50
1SFA611520R1001	69.50
1SFA611522R1101	135.10
1SFA611523R1001	69.50
1SFA611525R1101	135.10
1SFA611605R1100	3.10
1SFA611605R1101	17.90
1SFA611605R1102	34.70
1SFA611605R1103	52.00
1SFA611605R1110	17.90
1SFA611605R1111	34.70
1SFA611621R1011	26.60
1SFA611621R1012	26.60
1SFA611621R1013	26.60
1SFA611621R1014	26.60
1SFA611621R1015	26.60
1SFA611621R1041	26.60
1SFA611621R1042	26.60
1SFA611621R1043	26.60
1SFA611621R1044	26.60
1SFA611621R1045	26.60
1SFA611621R1071	26.60
1SFA611621R1072	26.60
1SFA611621R1073	26.60
1SFA611621R1074	26.60
1SFA611621R1075	26.60
1SFA619100R1012	19.50
1SFA619100R1013	19.50
1SFA619100R1014	19.50
1SFA619100R1016	19.50
1SFA619100R1022	29.60
1SFA619100R1026	29.60
1SFA619100R1041	19.50
1SFA619100R1071	29.60
1SFA619100R1072	29.60
1SFA619100R1076	29.60
1SFA619101R1012	52.00
1SFA619101R1016	52.00

Index

Order Code	List price (RM)
1SFA619101R1072	52.00
1SFA619101R1076	52.00
1SFA619403R5021	23.60
1SFA619403R5022	23.60
1SFA619403R5023	23.60
1SFA619403R5024	23.60
1SFA619403R5028	23.60
1SFA619403R5131	23.60
1SFA619403R5132	23.60
1SFA619403R5133	23.60
1SFA619403R5134	23.60
1SFA619403R5138	23.60
1SFA619403R5231	23.60
1SFA619403R5232	23.60
1SFA619403R5233	23.60
1SFA619403R5234	23.60
1SFA619403R5238	23.60
1SFA619500R1041	68.40
1SFA619500R1071	68.40
1SFA619550R1041	85.80
1SFA619550R1071	85.80
1SFA739001R1000	9,145.60
1SFL427001R1111	2,215.60
1SFL427001R1211	2,215.60
1SFL427001R1311	2,215.60
1SFL427001R1411	2,215.60
1SFL427101R1100	4,264.80
1SFL427101R1200	4,264.80
1SFL427101R1300	4,264.80
1SFL427101R1400	4,264.80
1SFL431022R..11	1,577.10
1SFL431024R..00	2,756.20
1SFL431074R..11	720.60
1SFL447101R1100	5,035.60
1SFL447101R1200	5,035.60
1SFL447101R1300	5,035.60
1SFL447101R1400	5,035.60
1SFL451022R..11	1,815.70
1SFL451024R..00	2,845.60
1SFL467001R1111	3,007.90
1SFL467001R1211	3,007.90
1SFL467001R1311	3,007.90
1SFL467001R1411	3,007.90
1SFL487002R1111	3,699.10
1SFL487002R1211	3,699.10
1SFL487002R1311	3,699.10
1SFL487002R1411	3,699.10
1SFL487102R1100	7,093.90
1SFL487102R1200	7,093.90
1SFL487102R1300	7,093.90

Order Code	List price (RM)
1SFL487102R1400	7,093.90
1SFL491074R..11	1,784.50
1SFL501074R..11	3,594.80
1SFL527002R1111	4,674.00
1SFL527002R1211	4,674.00
1SFL527002R1311	4,674.00
1SFL527002R1411	4,674.00
1SFL527102R1100	8,544.00
1SFL527102R1200	8,544.00
1SFL527102R1300	8,544.00
1SFL527102R1400	8,544.00
1SFL547002R1111	5,385.60
1SFL547002R1211	5,385.60
1SFL547002R1311	5,385.60
1SFL547002R1411	5,385.60
1SFL547074R..11	3,607.80
1SFL547102R1100	9,614.00
1SFL547102R1200	9,614.00
1SFL547102R1300	9,614.00
1SFL547102R1400	9,614.00
1SFL577001R6811	4,293.30
1SFL577001R6911	4,293.30
1SFL577001R7011	4,293.30
1SFL577001R7111	4,293.30
1SFL587002R1111	5,995.10
1SFL587002R1211	5,995.10
1SFL587002R1311	5,995.10
1SFL587002R1411	5,995.10
1SFL587074R..11	3,664.80
1SFL587102R1100	12,043.70
1SFL587102R1200	12,043.70
1SFL587102R1300	12,043.70
1SFL587102R1400	12,043.70
1SFL597001R6811	6,159.70
1SFL597001R6911	6,159.70
1SFL597001R7011	6,159.70
1SFL597001R7111	6,159.70
1SFL607002R1111	6,421.60
1SFL607002R1211	6,421.60
1SFL607002R1311	6,421.60
1SFL607002R1411	6,421.60
1SFL607074R..11	3,722.90
1SFL607102R1100	12,682.70
1SFL607102R1200	12,682.70
1SFL607102R1300	12,682.70
1SFL607102R1400	12,682.70
1SFL617001R6811	8,376.40
1SFL617001R6911	8,376.40
1SFL617001R7011	8,376.40
1SFL617001R7111	8,376.40

Index

Order Code	List price (RM)
1SFL637001R6811	14,310.80
1SFL637001R6911	14,310.80
1SFL637001R7011	14,310.80
1SFL637001R7111	14,310.80
1SFL657001R7011	23,681.00
1SFL677001R7011	60,045.30
1SFL981074R..11	800.70
1SFL991074R..11	1,514.30
1SFN010720R1011	80.10
1SFN010720R3311	80.10
1SFN010820R1011	80.10
1SFN010820R3311	80.10
1SFN019820R1011	80.10
1SFN019820R3311	80.10
1SBN030100R1000	112.80
1SFN030300R1000	202.80
1SFN034700R1000	197.10
1SFN035700R1000	432.50
1SFN155770R6806	2,153.30
1SFN155770R6906	2,153.30
1SFN155770R7006	2,153.30
1SFN155770R7106	2,153.30
1SFN156170R6806	2,512.50
1SFN156170R6906	2,512.50
1SFN156170R7006	2,512.50
1SFN156170R7106	2,512.50
1SFN156570R7026	790.20
1SFN166521R1070	8,252.60
1SKM990000R1301	235.00
1SKM990000R1302	310.00
1SKM990000R1303	405.00
1SKM990000R1304	495.00
1SKM990000R1305	625.00
1SKM990000R1801	235.00
1SKM990000R1802	310.00
1SKM990000R1803	405.00
1SKM990000R1804	495.00
1SKM990000R1805	625.00
1SLM004100A1102	100.50
1SLM004100A1103	134.70
1SLM004100A1104	202.10
1SLM004100A1105	230.90
1SLM004100A1106	342.10
1SLM004100A1107	342.10
1SLM004100A1108	461.80
1SLM004100A1109	601.80
1SLM004100A1110	684.10
1SLM004100A1202	88.80
1SLM004100A1203	124.00
1SLM004100A1204	186.00

Order Code	List price (RM)
1SLM004100A1205	216.00
1SLM004100A1206	338.90
1SLM004100A1207	338.90
1SLM004100A1208	431.90
1SLM004100A1209	598.60
1SLM004100A1210	677.70
1SPY001742D0123	25.80
1SPY001742D0123	51.60
1SPY001742D0123	77.40
1SPY001742D0123	103.20
1SPY001742D0123	129.00
1SPE007717F0310	100.50
1SPE007717F0320	88.80
1SPE007717F0410	134.70
1SPE007717F0420	124.00
1SPE007717F0510	230.90
1SPE007717F0520	216.00
1SPE007717F0610	342.10
1SPE007717F0620	338.90
1SPE007717F0710	461.80
1SPE007717F0720	431.90
1SPE007717F0810	202.10
1SPE007717F0820	186.00
1SPE007717F0910	342.10
1SPE007717F0920	338.90
1SPE007717F1010	601.80
1SPE007717F1020	598.60
1SPE007717F1110	684.10
1SPE007717F1120	677.70
1SVR405611R0100	31.50
1SVR405611R1100	31.50
1SVR405611R2100	31.50
1SVR405611R3100	31.50
1SVR405611R4100	31.50
1SVR405611R4300	31.50
1SVR405611R5100	31.50
1SVR405611R6100	31.50
1SVR405611R7100	31.50
1SVR405611R8100	31.50
1SVR405611R8300	31.50
1SVR405611R9100	31.50
1SVR405613R0100	39.50
1SVR405613R1100	39.50
1SVR405613R2100	39.50
1SVR405613R3100	39.50
1SVR405613R4100	39.50
1SVR405613R4300	39.50
1SVR405613R5100	39.50
1SVR405613R6100	39.50
1SVR405613R7100	39.50

Index

Order Code	List price (RM)
1SVR405613R8100	39.50
1SVR405613R8300	39.50
1SVR405613R9100	39.50
1SVR405621R0100	31.50
1SVR405621R1100	31.50
1SVR405621R2100	31.50
1SVR405621R3100	31.50
1SVR405621R4100	31.50
1SVR405621R5100	31.50
1SVR405621R6100	31.50
1SVR405621R7100	31.50
1SVR405621R8100	31.50
1SVR405621R9100	31.50
1SVR405622R0100	39.50
1SVR405622R1100	39.50
1SVR405622R2100	39.50
1SVR405622R3100	39.50
1SVR405622R4100	39.50
1SVR405622R5100	39.50
1SVR405622R6100	39.50
1SVR405622R7100	39.50
1SVR405622R8100	39.50
1SVR405622R9100	39.50
1SVR405631R1000	20.90
1SVR405631R1100	23.90
1SVR405631R3000	20.90
1SVR405631R3100	23.90
1SVR405633R1000	23.90
1SVR405633R1100	26.90
1SVR405633R3000	23.90
1SVR405633R3100	26.90
1SVR405651R1000	15.80
1SVR405651R1400	12.10
1SVR405651R3000	15.80
1SVR405651R3400	14.90
1SVR405652R1000	19.20
1SVR405652R4100	19.20
1SVR405652R9100	19.20
1SVR405655R1000	28.20
1SVR405655R1100	28.20
1SVR405655R4100	28.20
1SVR405658R6000	29.30
1SVR405659R1000	4.60
1SVR405660R0000	31.50
1SVR405660R1100	15.80
1SVR405669R0000	15.80
1SVR405670R0000	31.50
1SVR405670R1100	15.80
1SVR423418R9000	704.30
1SVR427030R0000	391.10

Order Code	List price (RM)
1SVR427031R0000	469.20
1SVR427032R0000	704.30
1SVR427034R0000	977.20
1SVR427035R0000	1,758.40
1SVR427036R0000	2,344.50
1SVR427071R0000	1,641.40
1SVR427075R0000	672.10
1SVR550870R9400	566.40
1SVR550871R9500	566.40
1SVR730700R0100	475.10
1SVR730700R0200	516.80
1SVR730700R2100	475.10
1SVR730700R2200	516.80
1SVR730794R1300	1,093.60
1SVR730794R3300	1,093.60
1SVR730824R9300	387.30
1SVR730830R0400	1,170.30
1SVR730840R0300	976.40
1SVR730840R0500	976.40
1SVR730884R1300	1,093.60
1SVR730884R3300	1,093.60
1SVR730885R1300	1,093.60
1SVR730885R3300	1,093.60
2CCP812001R1329	899.00
2CCP812001R1849	1,644.80
2CCP813001R1329	1,330.90
2CCP813001R1849	2,466.80
2CCP814001R1329	1,781.80
2CCP814001R1849	3,308.90
2CCP842001R1109	921.60
2CCP842001R1139	921.60
2CCP842001R1169	921.60
2CCP842001R1209	921.60
2CCP842001R1259	921.60
2CCP842001R1329	921.60
2CCP842001R1409	1,028.80
2CCP842001R1509	1,028.80
2CCP842001R1639	1,028.80
2CCP842001R1809	1,326.70
2CCP842001R1829	1,326.70
2CCP842001R1849	1,366.10
2CCP843001R1109	1,297.10
2CCP843001R1139	1,297.10
2CCP843001R1169	1,297.10
2CCP843001R1209	1,297.10
2CCP843001R1259	1,297.10
2CCP843001R1329	1,297.10
2CCP843001R1409	1,449.70
2CCP843001R1509	1,449.70
2CCP843001R1639	1,449.70

Index

Order Code	List price (RM)
2CCP843001R1809	1,870.90
2CCP843001R1829	1,870.90
2CCP843001R1849	1,932.30
2CCP844001R1109	1,833.70
2CCP844001R1139	1,833.70
2CCP844001R1169	1,833.70
2CCP844001R1209	1,833.70
2CCP844001R1259	1,833.70
2CCP844001R1329	1,833.70
2CCP844001R1409	2,046.80
2CCP844001R1509	2,046.80
2CCP844001R1639	2,046.80
2CCP844001R1809	2,645.00
2CCP844001R1829	2,645.00
2CCP844001R1849	2,729.80
2CDD271111R0016	36.40
2CDD271111R0025	36.40
2CDD271111R0032	39.80
2CDD271111R0040	39.80
2CDD271111R0050	51.00
2CDD271111R0063	51.00
2CDD272111R0016	58.00
2CDD272111R0025	58.00
2CDD272111R0032	63.60
2CDD272111R0040	63.60
2CDD272111R0050	75.80
2CDD272111R0063	75.80
2CDD273111R0016	77.30
2CDD273111R0025	77.30
2CDD273111R0032	96.30
2CDD273111R0040	96.30
2CDD273111R0050	117.10
2CDD273111R0063	117.10
2CDD274111R0016	119.20
2CDD274111R0025	119.20
2CDD274111R0032	125.20
2CDD274111R0040	125.20
2CDD274111R0050	147.30
2CDD274111R0063	147.30
2CDD281101R0016	40.00
2CDD281101R0025	40.00
2CDD281101R0032	43.80
2CDD281101R0040	43.80
2CDD281101R0050	56.10
2CDD281101R0063	56.10
2CDD282101R0016	63.70
2CDD282101R0025	63.70
2CDD282101R0032	70.00
2CDD282101R0040	70.00
2CDD282101R0050	83.30

Order Code	List price (RM)
2CDD282101R0063	83.30
2CDD283101R0016	85.00
2CDD283101R0025	85.00
2CDD283101R0032	106.00
2CDD283101R0040	106.00
2CDD283101R0050	128.90
2CDD283101R0063	128.90
2CDD284101R0016	131.10
2CDD284101R0025	131.10
2CDD284101R0032	137.70
2CDD284101R0040	137.70
2CDD284101R0050	162.10
2CDD284101R0063	162.10
2CDS200909R0001	127.30
2CDS200909R0002	127.30
2CDS200912R0001	101.90
2CDS200922R0001	120.00
2CDS200936R0001	101.90
2CDS200936R0002	101.90
2CDS200936R0003	101.90
2CDS200970R0001	79.60
2CDS200970R0002	79.60
2CDS211001R0064	24.10
2CDS211001R0065	36.50
2CDS211001R0104	24.10
2CDS211001R0105	36.50
2CDS211001R0164	24.10
2CDS211001R0165	36.50
2CDS211001R0204	24.10
2CDS211001R0205	36.50
2CDS211001R0254	24.10
2CDS211001R0255	36.50
2CDS211001R0324	24.10
2CDS211001R0325	36.50
2CDS211001R0404	24.10
2CDS211001R0405	36.50
2CDS211001R0504	34.40
2CDS211001R0505	51.70
2CDS211001R0634	34.40
2CDS211001R0635	51.70
2CDS212001R0064	76.60
2CDS212001R0065	95.80
2CDS212001R0104	76.60
2CDS212001R0105	95.80
2CDS212001R0164	76.60
2CDS212001R0165	95.80
2CDS212001R0204	76.60
2CDS212001R0205	95.80
2CDS212001R0254	76.60
2CDS212001R0255	95.80

Index

Order Code	List price (RM)
2CDS212001R0324	76.60
2CDS212001R0325	95.80
2CDS212001R0404	76.60
2CDS212001R0405	95.80
2CDS212001R0504	107.20
2CDS212001R0505	135.30
2CDS212001R0634	107.20
2CDS212001R0635	135.30
2CDS213001R0064	118.40
2CDS213001R0065	156.20
2CDS213001R0104	118.40
2CDS213001R0105	156.20
2CDS213001R0164	118.40
2CDS213001R0165	156.20
2CDS213001R0204	118.40
2CDS213001R0205	156.20
2CDS213001R0254	118.40
2CDS213001R0255	156.20
2CDS213001R0324	118.40
2CDS213001R0325	156.20
2CDS213001R0404	118.40
2CDS213001R0405	156.20
2CDS213001R0504	166.00
2CDS213001R0505	218.40
2CDS213001R0634	166.00
2CDS213001R0635	218.40
2CDS241001R0064	22.20
2CDS241001R0065	30.70
2CDS241001R0104	22.20
2CDS241001R0105	30.70
2CDS241001R0164	22.20
2CDS241001R0165	30.70
2CDS241001R0204	22.20
2CDS241001R0205	30.70
2CDS241001R0254	22.20
2CDS241001R0255	30.70
2CDS241001R0324	22.20
2CDS241001R0325	30.70
2CDS241001R0404	22.20
2CDS241001R0405	30.70
2CDS242001R0064	66.30
2CDS242001R0065	83.70
2CDS242001R0104	66.30
2CDS242001R0105	83.70
2CDS242001R0164	66.30
2CDS242001R0165	83.70
2CDS242001R0204	66.30
2CDS242001R0205	83.70
2CDS242001R0254	66.30
2CDS242001R0255	83.70

Order Code	List price (RM)
2CDS242001R0324	66.30
2CDS242001R0325	83.70
2CDS242001R0404	66.30
2CDS242001R0405	83.70
2CDS243001R0064	100.40
2CDS243001R0065	122.50
2CDS243001R0104	100.40
2CDS243001R0105	122.50
2CDS243001R0164	100.40
2CDS243001R0165	122.50
2CDS243001R0204	100.40
2CDS243001R0205	122.50
2CDS243001R0254	100.40
2CDS243001R0255	122.50
2CDS243001R0324	100.40
2CDS243001R0325	122.50
2CDS243001R0404	100.40
2CDS243001R0405	122.50
2CDS251001R0064	28.60
2CDS251001R0065	40.90
2CDS251001R0104	28.60
2CDS251001R0105	40.90
2CDS251001R0164	28.60
2CDS251001R0204	28.60
2CDS251001R0205	28.60
2CDS251001R0254	40.90
2CDS251001R0255	28.60
2CDS251001R0324	40.90
2CDS251001R0325	28.60
2CDS251001R0404	40.90
2CDS251001R0405	28.60
2CDS251001R0504	40.90
2CDS251001R0505	66.40
2CDS251001R0634	40.90
2CDS251001R0635	66.40
2CDS251001R1165	40.90
2CDS252001R0064	90.00
2CDS252001R0065	104.10
2CDS252001R0104	90.00
2CDS252001R0105	104.10
2CDS252001R0164	90.00
2CDS252001R0165	104.10
2CDS252001R0204	90.00
2CDS252001R0205	104.10
2CDS252001R0254	90.00
2CDS252001R0255	104.10
2CDS252001R0324	90.00
2CDS252001R0325	104.10
2CDS252001R0404	90.00
2CDS252001R0405	104.10

Index

Order Code	List price (RM)
2CDS252001R0504	115.40
2CDS252001R0505	148.00
2CDS252001R0634	115.40
2CDS252001R0635	148.00
2CDS253001R0064	141.50
2CDS253001R0065	173.50
2CDS253001R0104	141.50
2CDS253001R0105	173.50
2CDS253001R0164	141.50
2CDS253001R0165	173.50
2CDS253001R0204	141.50
2CDS253001R0205	173.50
2CDS253001R0254	141.50
2CDS253001R0255	173.50
2CDS253001R0324	141.50
2CDS253001R0325	173.50
2CDS253001R0404	141.50
2CDS253001R0405	173.50
2CDS253001R0504	219.10
2CDS253001R0505	234.70
2CDS253001R0634	219.10
2CDS253001R0635	234.70
2CDS254001R0064	200.00
2CDS254001R0065	234.70
2CDS254001R0104	200.00
2CDS254001R0105	234.70
2CDS254001R0164	200.00
2CDS254001R0165	234.70
2CDS254001R0204	200.00
2CDS254001R0205	234.70
2CDS254001R0254	200.00
2CDS254001R0255	234.70
2CDS254001R0324	200.00
2CDS254001R0325	234.70
2CDS254001R0404	200.00
2CDS254001R0405	234.70
2CDS254001R0504	244.90
2CDS254001R0505	285.70
2CDS254001R0634	244.90
2CDS254001R0635	285.70
2CDS271001R0064	71.50
2CDS271001R0065	76.00
2CDS271001R0104	71.50
2CDS271001R0105	76.00
2CDS271001R0164	71.50
2CDS271001R0165	76.00
2CDS271001R0204	71.50
2CDS271001R0205	76.00
2CDS271001R0254	71.50
2CDS271001R0255	76.00

Order Code	List price (RM)
2CDS271001R0324	71.50
2CDS271001R0325	76.00
2CDS271001R0404	71.50
2CDS271001R0405	76.00
2CDS271001R0504	113.50
2CDS271001R0505	130.20
2CDS271001R0634	113.50
2CDS271001R0635	130.20
2CDS272001R0064	144.70
2CDS272001R0065	156.70
2CDS272001R0104	144.70
2CDS272001R0105	156.70
2CDS272001R0164	144.70
2CDS272001R0165	156.70
2CDS272001R0204	144.70
2CDS272001R0205	156.70
2CDS272001R0254	144.70
2CDS272001R0255	156.70
2CDS272001R0324	144.70
2CDS272001R0325	156.70
2CDS272001R0404	144.70
2CDS272001R0405	156.70
2CDS272001R0504	173.50
2CDS272001R0505	193.90
2CDS272001R0634	173.50
2CDS272001R0635	193.90
2CDS273001R0064	215.50
2CDS273001R0065	214.90
2CDS273001R0104	215.50
2CDS273001R0105	214.90
2CDS273001R0164	215.50
2CDS273001R0165	214.90
2CDS273001R0204	215.50
2CDS273001R0205	214.90
2CDS273001R0254	215.50
2CDS273001R0255	214.90
2CDS273001R0324	215.50
2CDS273001R0325	214.90
2CDS273001R0404	215.50
2CDS273001R0405	214.90
2CDS273001R0504	244.90
2CDS273001R0505	255.10
2CDS273001R0634	244.90
2CDS273001R0635	255.10
2CDS274001R0064	255.10
2CDS274001R0065	275.50
2CDS274001R0104	255.10
2CDS274001R0105	275.50
2CDS274001R0164	255.10
2CDS274001R0165	275.50

Index

Order Code	List price (RM)
2CDS274001R0204	255.10
2CDS274001R0205	275.50
2CDS274001R0254	255.10
2CDS274001R0255	275.50
2CDS274001R0324	255.10
2CDS274001R0325	275.50
2CDS274001R0404	255.10
2CDS274001R0405	275.50
2CDS274001R0504	275.50
2CDS274001R0505	306.10
2CDS274001R0634	275.50
2CDS274001R0635	306.10
2CDS281001R0064	112.30
2CDS281001R0065	112.30
2CDS281001R0104	112.30
2CDS281001R0105	112.30
2CDS281001R0164	112.30
2CDS281001R0165	112.30
2CDS281001R0204	112.30
2CDS281001R0205	112.30
2CDS281001R0254	112.30
2CDS281001R0255	112.30
2CDS281001R0324	112.30
2CDS281001R0325	112.30
2CDS281001R0404	112.30
2CDS281001R0405	112.30
2CDS281001R0504	132.70
2CDS281001R0505	132.70
2CDS281001R0634	132.70
2CDS281001R0635	132.70
2CDS282001R0064	224.50
2CDS282001R0065	224.50
2CDS282001R0104	224.50
2CDS282001R0105	224.50
2CDS282001R0164	224.50
2CDS282001R0165	224.50
2CDS282001R0204	224.50
2CDS282001R0205	224.50
2CDS282001R0254	224.50
2CDS282001R0255	224.50
2CDS282001R0324	224.50
2CDS282001R0325	224.50
2CDS282001R0404	224.50
2CDS282001R0405	224.50
2CDS282001R0504	265.30
2CDS282001R0505	265.30
2CDS282001R0634	265.30
2CDS282001R0635	265.30
2CDS283001R0064	336.70
2CDS283001R0065	336.70

Order Code	List price (RM)
2CDS283001R0104	336.70
2CDS283001R0105	336.70
2CDS283001R0164	336.70
2CDS283001R0165	336.70
2CDS283001R0204	336.70
2CDS283001R0205	336.70
2CDS283001R0254	336.70
2CDS283001R0255	336.70
2CDS283001R0324	336.70
2CDS283001R0325	336.70
2CDS283001R0404	336.70
2CDS283001R0405	336.70
2CDS283001R0504	377.60
2CDS283001R0505	377.60
2CDS283001R0634	377.60
2CDS283001R0635	377.60
2CDS284001R0064	489.80
2CDS284001R0065	489.80
2CDS284001R0104	489.80
2CDS284001R0105	489.80
2CDS284001R0164	489.80
2CDS284001R0165	489.80
2CDS284001R0204	489.80
2CDS284001R0205	489.80
2CDS284001R0254	489.80
2CDS284001R0255	489.80
2CDS284001R0324	489.80
2CDS284001R0325	489.80
2CDS284001R0404	489.80
2CDS284001R0405	489.80
2CDS284001R0504	561.20
2CDS284001R0505	561.20
2CDS284001R0634	561.20
2CDS284001R0635	561.20
2CMA100014R1000	613.50
2CMA100149R1000	1,022.10
2CMA100150R1000	1,362.10
2CMA100163R1000	1,635.50
2CMA100164R1000	1,874.60
2CMA100177R1000	1,635.50
2CMA100178R1000	1,874.60
2CSF200989R0005	999.20
2CSF200990R0005	799.30
2CSF200991R0005	999.20
2CSF200992R0005	799.30
2CSF202001R0250	347.10
2CSF202005R1250	334.70
2CSF202005R1400	292.40
2CSF202005R1630	418.40
2CSF202005R1800	476.20

Index

Order Code	List price (RM)
2CSF202005R1900	748.40
2CSF202005R2250	317.50
2CSF202005R2400	303.40
2CSF202005R2630	395.50
2CSF202005R2800	500.60
2CSF202005R2900	603.70
2CSF202005R3250	334.70
2CSF202005R3400	303.40
2CSF202005R3630	395.50
2CSF202005R3800	476.20
2CSF202005R3900	575.10
2CSF202005R4800	476.20
2CSF202005R4900	575.10
2CSF202006R1250	260.90
2CSF202006R1400	205.20
2CSF202006R1630	278.40
2CSF202006R2250	240.10
2CSF202006R2400	161.40
2CSF202006R2630	214.50
2CSF202006R3250	260.80
2CSF202006R3400	233.30
2CSF202006R3630	305.10
2CSF202401R1250	468.40
2CSF202401R1400	409.60
2CSF202401R1630	584.90
2CSF204001R1950	643.80
2CSF204001R2950	643.80
2CSF204001R3950	1,024.10
2CSF204001R4950	3,350.70
2CSF204005R1250	460.00
2CSF204005R1400	460.00
2CSF204005R1630	731.70
2CSF204005R1800	748.40
2CSF204005R1900	803.40
2CSF204005R2250	460.00
2CSF204005R2400	357.50
2CSF204005R2630	511.00
2CSF204005R2800	785.80
2CSF204005R2900	779.50
2CSF204005R3250	460.00
2CSF204005R3400	376.20
2CSF204005R3630	414.30
2CSF204005R3800	748.40
2CSF204005R3900	730.60
2CSF204005R4800	748.40
2CSF204005R4900	898.20
2CSF204006R1250	382.70
2CSF204006R1400	322.70
2CSF204006R1630	501.60
2CSF204006R2250	452.30

Order Code	List price (RM)
2CSF204006R2400	315.50
2CSF204006R2630	412.10
2CSF204006R3250	348.00
2CSF204006R3400	258.20
2CSF204006R3630	318.00
2CSF204401R1250	643.80
2CSF204401R1400	643.80
2CSF204401R1630	1,024.10
2CSG035100R1211	359.70
2CSG060100R1211	409.40
2CSG080100R1211	570.40
2CSG110100R1211	706.50
2CSG152130R1202	975.10
2CSG152436R1202	1,218.40
2CSG160100R1211	1,188.20
2CSG296992R4052	2,896.70
2CSG299943R4052	2,557.80
2CSM200923R1801	20.60
2CSM204693R1801	63.70
2CSM204703R1801	91.20
2CSM204713R1801	42.50
2CSM204753R1801	75.00
2CSM213456R1801	98.40
2CSM213466R1801	98.40
2CSM213476R1801	98.40
2CSM213486R1801	98.40
2CSM213496R1801	98.40
2CSM213506R1801	98.40
2CSM213516R1801	98.40
2CSM213526R1801	98.40
2CSM213536R1801	98.40
2CSM213546R1801	98.40
2CSM213556R1801	98.40
2CSM213566R1801	98.40
2CSM213576R1801	98.40
2CSM213586R1801	98.40
2CSM256913R1801	132.00
2CSM277113R1801	27.10
2CSM277113R1801	14.10
2CSM258723R1801	14.10
2CSM257543R1801	14.10
2CSM256363R1801	14.10
2CSM258633R1801	14.10
2CSM257453R1801	14.10
2CSM256273R1801	14.10
2CSM277543R1801	14.10
2CSM277323R1801	14.10
2CSM277103R1801	14.10
2CSM258713R1801	14.10
2CSR255040R1064	751.40

Index

Order Code	List price (RM)
2CSR255040R1104	751.40
2CSR255040R1134	751.40
2CSR255040R1164	751.40
2CSR255040R1204	751.40
2CSR255040R1254	751.40
2CSR255040R1324	751.40
2CSR255040R1404	751.40
2CSR255040R2064	714.90
2CSR255040R2104	714.90
2CSR255040R2134	714.90
2CSR255040R2164	714.90
2CSR255040R2204	714.90
2CSR255040R2254	714.90
2CSR255040R2324	714.90
2CSR255040R2404	714.90
2CSR255040R3064	789.90
2CSR255040R3104	789.90
2CSR255040R3134	789.90
2CSR255040R3164	789.90
2CSR255040R3204	789.90
2CSR255040R3254	789.90
2CSR255040R3324	789.90
2CSR255040R3404	789.90
2CSS201997R0013	3,531.00
2CSS203997R0013	3,531.00
2CSS204997R0013	3,531.00
2CTB815101R1500	3,906.70
2CTB815101R1000	4,590.20
2CTB815101R1600	7,354.60
2CTB815101R0700	7,922.60
2CTB815710R1300	3,780.60
2CTB815710R0100	4,224.40
2CTB815710R1900	6,257.10
2CTB815710R0700	7,195.80
2CTB815710R2600	855.90
2CTB815710R2700	1,029.70
2CTB815708R1400	1,406.10
2CTB815708R0200	1,654.50
2CTB803972R1100	633.00
2CTB803972R0500	1,082.30
2CTB815708R2000	2,148.20
2CTB815708R0800	2,282.20
2CTB803973R1100	1,053.50
2CTB803973R0500	1,173.10
2CTB803972R1200	745.30
2CTB803972R1300	1,271.40
2CTB803973R1200	1,334.00
2CTB803973R1600	2,276.50
2CTB803873R5800	2,075.50
2CTB815708R2600	513.40

Order Code	List price (RM)
2CTB803876R1000	370.20
2CTB815708R2800	916.10
2CTB803876R1200	274.30
2CTB803876R0000	618.40
2CTB803953R5300	1,053.50
2CTB803953R5400	1,173.10
2CTB803953R6500	1,237.00
2CTB804153R2400	1,082.30
2GCA286141A0050	31,655.00
2GCA291720A0050	6,946.00
2GCA291721A0050	8,776.00
2GCA291722A0050	9,634.00
2GCA291864A0050	3,513.00
2GCA291880A0050	4,212.00
2GCA292040A0050	702.00
2GCA292820A0050	28,941.00
2GCA296763A0031	735.00
2GCA296768A0031	782.00
2GCA296773A0031	678.00
2GCA296778A0031	684.00
2GCA296783A0031	692.00
2GCA296788A0031	699.00
2GCA296793A0031	753.00
2GCA296796A0031	735.00
2GCA296799A0031	782.00
2GCA296837A0031	903.00
2GCA296842A0031	722.00
2GCA296847A0031	722.00
2GCA296852A0031	702.00
2GCA296857A0031	722.00
2GCA296862A0031	722.00
2GCA296867A0031	903.00
2GSB010146A0022	989.00
2GSB010149A0022	1,146.00
2GSB010150A0022	1,528.00
2GSB010151A0022	1,528.00
2GSB010153A0022	1,909.00
2GSB010154A0022	1,909.00
2GSB010155A0022	1,888.00
2GSB010156A0022	2,291.00
2GSB010157A0022	2,874.00
2GSB010158A0022	3,145.00
2GSB010159A0022	4,310.00
2GSB010163A0022	6,464.00
2GSB010147A0022	7,182.00
2GSB010160A0022	5,028.00
2GSB010161A0022	5,386.00
2GSB010162A0022	5,745.00
2GSB010163A0022	6,464.00
2GSB010323A0022	989.00

Index

Order Code	List price (RM)
2GSB010367A0022	2,515.00
2GSB010368A0022	3,232.00
2GSB010369A0022	4,669.00
2GSB010370A0022	6,104.00
2GSB010174A0022	7,039.00
2GSB010176A0022	1,077.00
2GSB010177A0022	8,798.00
2GSB010179A0022	10,558.00
2GSB010180A0022	1,321.00
2GSB010182A0022	1,761.00
2GSB010186A0022	2,640.00
2GSB010183A0022	1,761.00
2GSB010184A0022	2,200.00
2GSB010187A0022	2,640.00
2GSB010188A0022	3,079.00
2GSB010419A0022	977.00
2GSB010422A0022	2,200.00
2GSB010423A0022	6,599.00
2GSB010450A0022	3,521.00
2GSB010453A0022	4,400.00
2GSB010454A0022	5,279.00
2GSB010455A0022	6,160.00
2GSB010469A0022	3,873.00
2GSB010424A0022	7,391.00
2GSB010425A0022	7,761.00
GHE3211102R0005	122.90
GHE3211102R0006	122.90
GHE3211202R0005	122.90
GHE3211202R0006	122.90
GHE3211302R0005	122.90
GHE3211302R0006	122.90
GHE3291102R0006	156.20
GHE3291202R0006	156.20
GHE3291302R0006	156.20
GHE3291602R0006	156.20
GHE3291702R0006	156.20
GHE3491102R0006	314.30
GHE3691102R0006	407.40
GHS2701916R0001	96.00
GHS2701916R0002	96.00
GHS2701916R0003	96.00
GHS2701917R0001	84.00
GHS2701917R0002	84.00
GHS2701917R0003	84.00
GHS2701936R0001	110.00
GHS2701936R0002	110.00
GHS2701936R0003	110.00
GHS2701936R0004	110.00
GHS2801901R0008	128.00
GHS2801902R0008	107.00

Order Code	List price (RM)
GHS2801909R0001	139.00
GHS2801909R0002	139.00
GJF1101903R0001	79.80
GJF1101903R0003	178.60
GJH1211001R.22.	133.60
GJH1211001R.31.	133.60
GJH1211001R.40.	133.60
GJH1213001R.22.	133.60
GJH1213001R.31.	133.60
GJH1213001R.40.	133.60
GJH1213061R.22.	197.80
GJH1213061R.31.	197.80
GJH1213061R.40.	197.80
GJL1201317R0001	63.90
GJL1201317R0002	63.90
GJL1201317R0003	63.90
GJL1201317R0004	63.90
GJL1201330R0001	63.90
GJL1201330R0002	63.90
GJL1201330R0003	63.90
GJL1201330R0004	63.90
GJL1201330R0005	63.90
GJL1201330R0006	63.90
GJL1201330R0007	63.90
GJL1201330R0008	63.90
GJL1201330R0009	63.90
GJL1201330R0010	63.90
GJL1201330R0011	63.90
GJL1201330R0012	63.90
GJL1201907R0001	16.60
GJL1201908R0001	53.60
GJL1211001R.01.	136.80
GJL1211001R.10.	136.80
GJL1211201R.00.	136.80
GJL1211901R.01.	279.80
GJL1211901R.10.	279.80
GJL1213001R.01.	136.80
GJL1213001R.10.	136.80
GJL1213001R5011	154.60
GJL1213001R5101	154.60
GJL1213001R8011	154.60
GJL1213001R8101	154.60
GJL1213901R.01.	279.80
GJL1213901R.10.	279.80
GJL1311001R.01.	151.50
GJL1311001R.10.	151.50
GJL1311201R.00.	151.50
GJL1311901R.01.	330.30
GJL1311901R.10.	330.30
GJL1313001R.01.	151.50

Index

Order Code	List price (RM)
GJL1313001R.10.	151.50
GJL1313001R5011	162.00
GJL1313001R5101	162.00
GJL1313001R8011	162.00
GJL1313001R8101	162.00
GJL1313061R.01.	197.80
GJL1313061R.10.	197.80
GJL1313901R.01.	330.30
GJL1313901R.10.	330.30
SK827041-AD	14,585.90
SK827041-AR	14,585.90
SK827041-EF	14,585.90
SK827041-EG	14,585.90
SK827041-EL	14,585.90
SK827041-EM	14,585.90
SK827041-EP	14,585.90
SK827041-ER	14,585.90
SK827044-AD	24,950.30
SK827044-EF	24,950.30
SK827044-EG	24,950.30
SK827044-EL	24,950.30
SK827044-EM	24,950.30
SK829002-A	91.80
SK829002-B	91.80
SK829002-C	91.80
SK829002-D	91.80
SK829071-A	204.40
SK829071-B	271.90
7TAG009040R0005	427.20
7TAG009040R0007	427.20
7TAG009040R0009	256.30
7TAG009040R0011	256.30
7TAG009050R0000	512.70
7TAG009050R0001	512.60
7TAG009050R0002	512.70
7TAG009050R0003	512.60
7TAG009120R0000	427.20
7TAG009120R0002	512.70
7TAG009120R0004	512.60
7TAG009130R0004	427.20
7TAG009130R0007	341.80
7TAG009130R0009	341.80
7TAG009210R0042	427.20
7TAG009210R0045	512.60
7TAG009210R0048	854.40
7TAG009210R0050	854.30
7TAG009220R0001	854.40
7TAG009220R0003	854.30
7TAG009320R0001	1,708.60
7TAG009320R0003	555.30

Order Code	List price (RM)
7TAG009320R0004	811.60
7TAG009330R0007	768.90
7TAG009330R0009	1,409.70
7TAG009330R0010	1,751.30
7TAG009330R0012	2,050.30
7TAG009330R0014	2,648.30
7TAG009340R0002	683.50
7TAG009340R0003	1,366.90
7TCA119100R0012	3,737.20
7TCA119100R0028	4,706.70
7TCA119100R0045	5,245.60
7TCA119100R0066	3,709.50
7TCA119100R0101	4,017.10
7TCA119100R0169	5,621.30
7TCA119110R0007	8,261.10
7TCA119110R0011	10,491.20
7TCA119110R0018	7,272.20
7TCA119110R0028	7,696.00
7TCA119110R0070	8,002.50
7TCA119300R0100	3,141.90
7TCA119300R0188	2,954.40
7TCA119300R0255	3,830.60
7TCA119300R0292	3,035.80
7TCA119300R0329	3,422.90
7TCA119300R0349	3,522.70
7TCA119320R0013	5,955.90
7TCA119320R0032	6,489.10
7TCA119320R0070	5,999.90
7TCA119320R0078	6,434.40
7TCA119500R0049	10,917.70
7TCA119500R0051	11,104.40
7TCA119500R0057	10,935.50
7TCA119500R0059	11,253.20
7TCA119500R0064	11,274.50
7TCA119500R0070	12,787.20
7TCA119500R0081	10,150.60
7TCA119500R0085	10,391.00
7TCA119500R0089	10,497.00
7TCA119500R0099	10,647.00
7TCA119500R0103	10,888.60
7TCA119500R0108	10,735.80
7TCA119500R0120	10,965.80
7TCA119500R0123	11,145.20
7TCA119500R0125	11,181.90
7TCA119500R0134	11,055.10
7TCA119500R0140	15,671.40
7TCA119500R0167	14,576.20
7TCA119500R0168	10,890.10
7TCA119500R0169	11,306.60
7TCA119500R0170	8,244.10

Index

Order Code	List price (RM)
7TCA119500R0172	7,282.80
7TCA296000R0134	12.90
7TCA296000R0188	18.20
7TCA296000R0212	22.50
7TCA296000R0350	18.80
7TCA296000R0384	11.00
7TCA296000R0585	12.60
7TCA296000R0620	37.70
7TCA296000R0797	14.10
7TCA296000R0832	33.20
7TCA296000R0957	34.30
7TCA296000R0983	40.30
7TCA296000R1081	61.80
7TCA296000R1106	47.50
7TCA296000R1213	72.20
7TCA296000R1236	98.40
7TCA296000R1966	4,111.60
7TCA296000R2015	1,359.90
7TCA296000R2033	1,942.00
7TCA296000R2047	3,205.80
7TCA296000R2143	356.40
7TCA296000R2155	468.80
7TCA296000R2176	628.00
7TCA296000R2207	1,038.10
7TCA296000R2234	1,664.40
7TCA296000R2251	2,103.60
7TCA297180R0361	288.60
7TCA297180R0362	293.80
7TCA297180R0363	343.40
7TCA297180R0364	388.50
7TCA297180R0365	407.60
7TCA297180R0366	542.60
7TCA297180R0367	381.50
7TCA297180R0368	725.20
7TCA297180R0369	1,036.20
7TCA297180R0370	1,158.50
7TCA297180R0371	1,701.50
7TCA297180R0372	1,827.10
7TCA297180R0373	2,773.60
7TCA297180R0374	3,013.10
7TCA297180R0375	5,263.90
7TCA297180R0376	5,613.10
7TCA297180R0377	288.60
7TCA297180R0378	293.80
7TCA297180R0379	249.90
7TCA297180R0380	282.70
7TCA297180R0381	407.60
7TCA297180R0382	394.80
7TCA297180R0383	381.50
7TCA297180R0384	725.20

Order Code	List price (RM)
7TCA297180R0385	753.90
7TCA297180R0386	842.90
7TCA297180R0387	1,237.80
7TCA297180R0388	1,329.30
7TCA297180R0389	2,017.80
7TCA297180R0390	2,192.10
7TCA297180R0391	3,829.60
7TCA297180R0392	4,083.50
7TCA297180R0406	227.50
7TCA297180R0407	231.70
7TCA297180R0408	210.90
7TCA297180R0409	219.80
7TCA297180R0410	249.80
7TCA297180R0411	256.60
7TCA297180R0412	510.00
7TCA297180R0413	522.30
7TCA297180R0414	776.20
7TCA297180R0415	1,003.20
7TCA297180R0539	374.00
7TCA297180R0540	380.50
7TCA297180R0541	374.00
7TCA297180R0542	380.50
7TCA297180R0574	218.50
7TCA297180R0575	1,311.50
7TCA297180R0576	1,695.20
7TCA297180R0577	218.50
7TCA297180R0578	228.40
7TCA297180R0579	232.40
7TCA297180R0580	290.50
7TCA297180R0581	302.80
7TCA297180R0582	428.80
7TCA297180R0583	440.20
7TCA297180R0584	875.40
7TCA297180R0585	896.70
7TCA297180R0586	1,332.80
7TCA297180R0587	1,311.50
7TCA297180R0588	1,722.20
7TCA297180R0589	1,695.20
7TCA297180R0896	1,162.20
7TCA297180R0897	6,109.70
7TCA297180R0899	8348.30
7TCA297180R0904	7,681.50
7TCA297180R0920	1,649.90
7TCA297180R0921	4,036.30
7TCA297180R0922	3,516.70
7TCA297180R0923	4,632.30
7TCA297180R0926	4,132.40
7TCA297180R0928	1,716.30
7TCA297180R0947	3516.70
7TCA297180R0949	1,716.30

Index

Order Code	List price (RM)
7TCA297180R0951	4,632.30
7TCA297180R0974	7,681.50
7TCA297180R0990	4,132.40
7TCA297180R1005	4,036.30
7TCA300040R0000	85.50
7TCA300040R0001	85.50
7TCA300040R0002	85.50
7TCA300040R0003	170.90
7TCA300080R0000	85.50
7TCA300080R0001	85.50
7TCA300080R0002	85.50
7TCA300080R0003	85.50
7TCA300120R0000	170.90
7TCA300120R0001	170.90
7TCA300120R0002	256.30
7TCA300120R0003	341.80
7TCA300160R0000	85.50
7TCA300160R0001	170.90
7TCA300160R0002	256.30
7TCA300160R0003	341.80
7TCA300200R0000	170.90
7TCA300200R0001	256.30
7TCA300200R0002	256.30
7TCA300200R0003	256.30
7TCA300200R0004	341.80
7TCA300240R0000	170.90
7TCA300240R0001	256.30
7TCA300240R0002	256.30
7TCA300240R0003	341.80
7TCA300240R0004	341.80
7TCA300260R0002	81.20
7TCA300260R0003	47.00
7TCA300280R0000	256.30
7TCA300280R0001	299.00
7TCA300300R0002	72.70
7TCA300300R0003	42.80
7TCA300320R0000	299.00
7TCA300320R0001	341.80
7TCA300340R0000	98.30
7TCA300340R0001	106.80
7TCA300360R0000	85.50
7TCA300360R0001	115.40
7TCA302310R0000	188.00
7TCA302310R0001	196.50
7TCA302310R0002	230.70
7TCA302310R0003	230.70
7TCA302310R0004	222.20
7TCA302310R0005	341.80
7TCA302310R0006	307.60
7TCA302310R0007	299.00

Order Code	List price (RM)
7TCA302310R0008	290.50
7TCA302310R0009	299.00
7TCA302310R0010	444.30
7TCA302310R0011	427.20
7TCA302310R0012	401.60
7TCA302310R0013	632.20
7TCA302310R0014	606.60
7TCA302310R0015	589.50
7TCA302310R0016	640.70
7TCA302310R0017	188.00
7TCA302320R0000	491.30
7TCA302320R0001	478.40
7TCA302320R0002	461.40
7TCA302320R0003	487.00
7TCA302320R0004	730.40
7TCA302320R0005	726.20
7TCA302320R0006	696.30
7TCA302320R0007	666.40
7TCA302320R0008	969.60
7TCA302320R0009	948.30
7TCA302320R0010	926.90
7TCA302320R0011	867.10
7TCA302320R0012	1,362.60
7TCA302320R0013	1,290.00
7TCA302320R0014	1,230.20
7TCA302320R0015	1,191.70
7TCA302330R0000	844.10
7TCA302330R0001	833.80
7TCA302330R0002	815.00
7TCA302330R0003	784.30
7TCA302330R0004	782.60
7TCA302330R0005	938.00
7TCA302330R0006	920.90
7TCA302330R0007	888.50
7TCA302330R0008	903.90
7TCA302330R0009	1,472.80
7TCA302330R0010	1,450.60
7TCA302330R0011	1,414.70
7TCA302330R0012	1,368.60
7TCA302330R0013	956.00
7TCA302330R0014	943.20
7TCA302330R0015	924.40
7TCA302330R0016	907.30
7TCA302330R0017	826.10
7TCA302330R0018	816.30
7TCA302330R0019	788.10
7TCG009130R0005	427.20
7TCG009130R0006	427.20
7TCG009380R0001	286.30
7TCG009380R0002	294.80

Index

Order Code	List price (RM)
7TCG009380R0003	299.10
7TCG009380R0005	294.80
7TCG009450R0162	384.50
7TCG009450R0163	427.20
05099	81.60
05098	59.10
05097	42.80
05096	30.20
05095	34.70
05094	30.40
05091	42.80
05089	47.00
05087	39.40
05085	29.00
05083	25.10
05069	27.90

Order Code	List price (RM)
05067	30.40
05065	18.90
05063	16.90
05047	20.30
05045	15.00
05043	12.10
05033	11.60
05314	145.50
05312	84.80
05310	77.90
05308	69.80
05306	57.70
05304	39.20
05302	34.00
05300	18.60

A series of horizontal dotted lines for writing.

Contact us

ABB Malaysia Sdn Bhd

Lot 608, Jalan Lagoon Selatan
Bandar Sunway
47500 Subang Jaya
Selangor Darul Ehsan, Malaysia
Tel : +603 5628 4888
Fax : +603 5635 8200

Customer Service Line:

Tel : +603 5628 4431/4433

Branches:

Johor

ABB Malaysia Sdn Bhd

Lot 28-01, Jalan Molek 1/10
Taman Molek, 81100 Johor Bahru
Johor Darul Takzim, Malaysia
Tel : +607 353 3655
Fax : +607 353 4767

Penang

ABB Malaysia Sdn Bhd

No. 2754, Jalan Chain Ferry
Taman Inderawasih, 13600 Prai
Penang, Malaysia
Tel : +604 399 9741/9744
Fax : +604 399 9749

Kuching

ABB Malaysia Sdn Bhd

Sublot 1, First Floor, Lot 4898
Jalan Mendu Commercial Center
93200 Kuching, Sarawak
Tel : +603 5628 4888
Fax : +603 5635 8200

www.abb.com/my

As part of its on-going product improvement, ABB reserves the right to modify the characteristics or the products described in this document. The information and price is not contractual. Please contact us for more details and clarification.

*Note: All List Prices Excluding 6% GST.